

[54] ARCUATE WINDOW MEASURING GAUGE

[76] Inventors: Curtis W. Halbert, 7300 Apache, Fort Worth, Tex. 76135; R. Allen McRee, 178 Buffalo Creek, Crandall, Tex. 75114

[**] Term: 14 Years

[21] Appl. No.: 245,537

[22] Filed: Sep. 19, 1988

[52] U.S. Cl. D10/65

[58] Field of Search D10/65; 33/403, 404, 33/418, 424, 452, 465, 471, 495, 496, 497, 498, 499, 500, 534, 535, 536, 537, 538, 626, 630, 633, 634, 640, 760, 768, 775, 712, 759, 1 F, 1 N, 1 SP, 1 PT, 1 AP

[56] References Cited

U.S. PATENT DOCUMENTS

D. 187,551 3/1960 Misner D10/52 X

D. 312,795 12/1990 Fugett D10/62
3,021,599 2/1962 Odom 33/760 X
3,651,574 3/1972 Burkart 33/760 X
4,700,489 10/1987 Vasile D10/72 X

Primary Examiner—Nelson C. Holtje
Assistant Examiner—Antoine D. Davis
Attorney, Agent, or Firm—Charles W. McHugh

[57] CLAIM

The ornamental design for an arcuate window measuring gauge, as shown.

DESCRIPTION

FIG. 1 is a top, front and right side perspective view of an arcuate window measuring gauge showing our new design;
FIG. 2 is a front elevational view;
FIG. 3 is a right side elevational view;
FIG. 4 is a top plan view;
FIG. 5 is a bottom plan view;
FIG. 6 is a left side elevational view; and
FIG. 7 is a rear elevational view thereof.

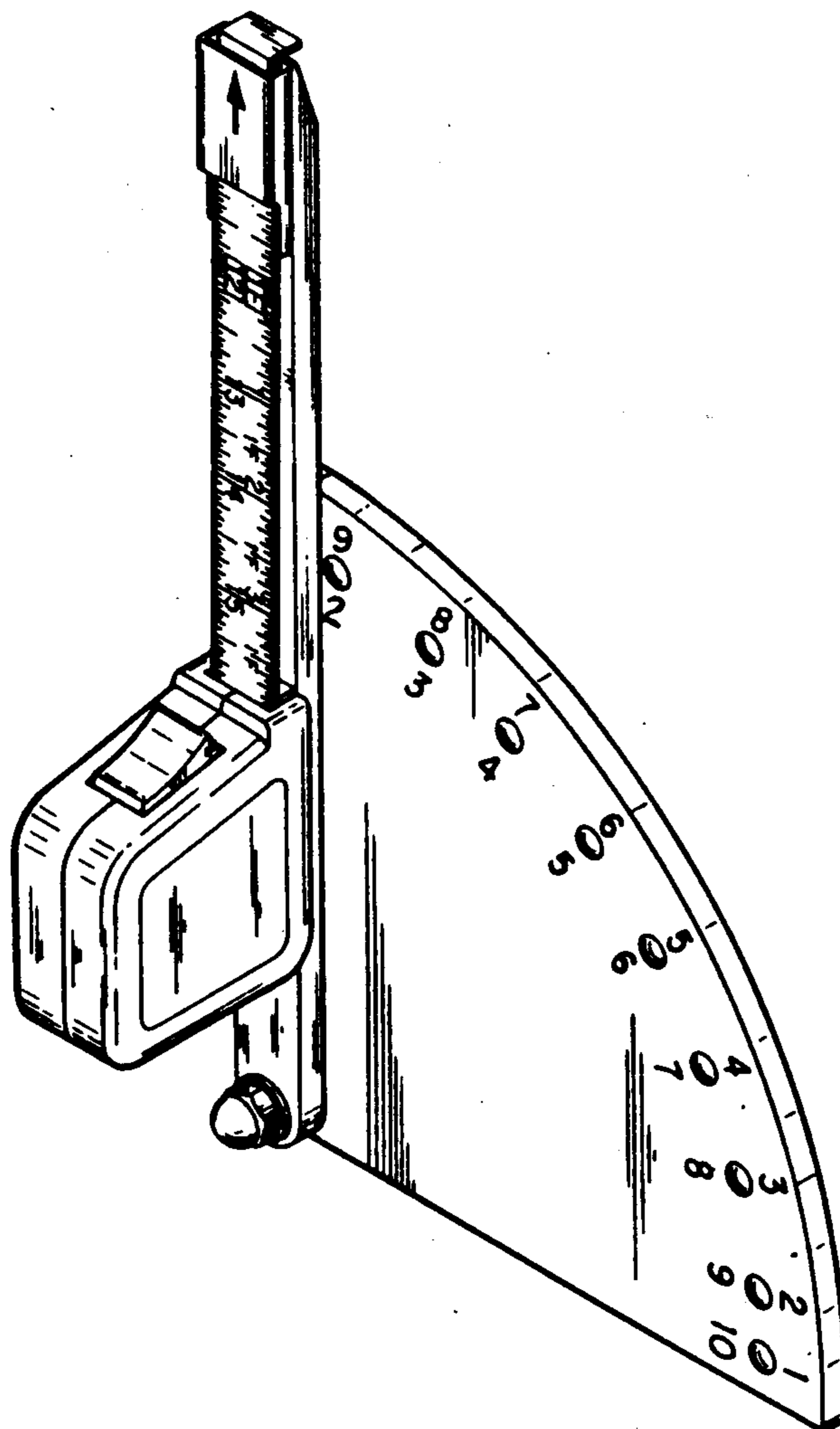

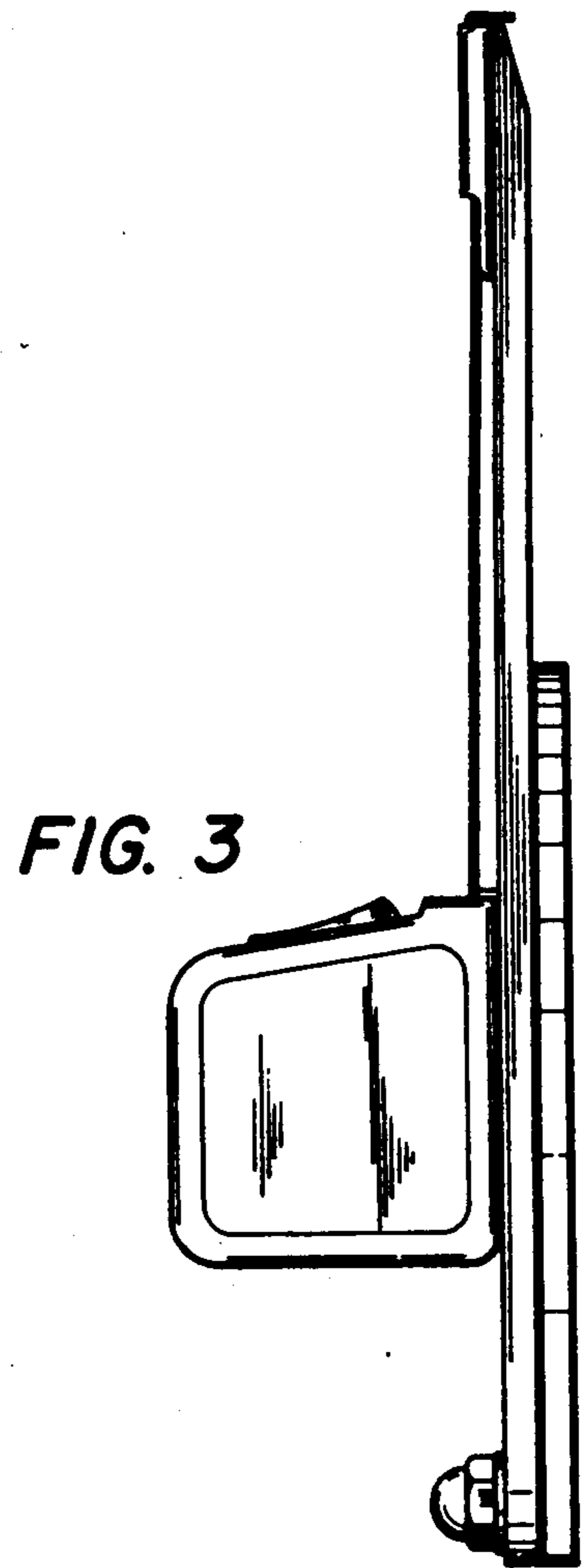
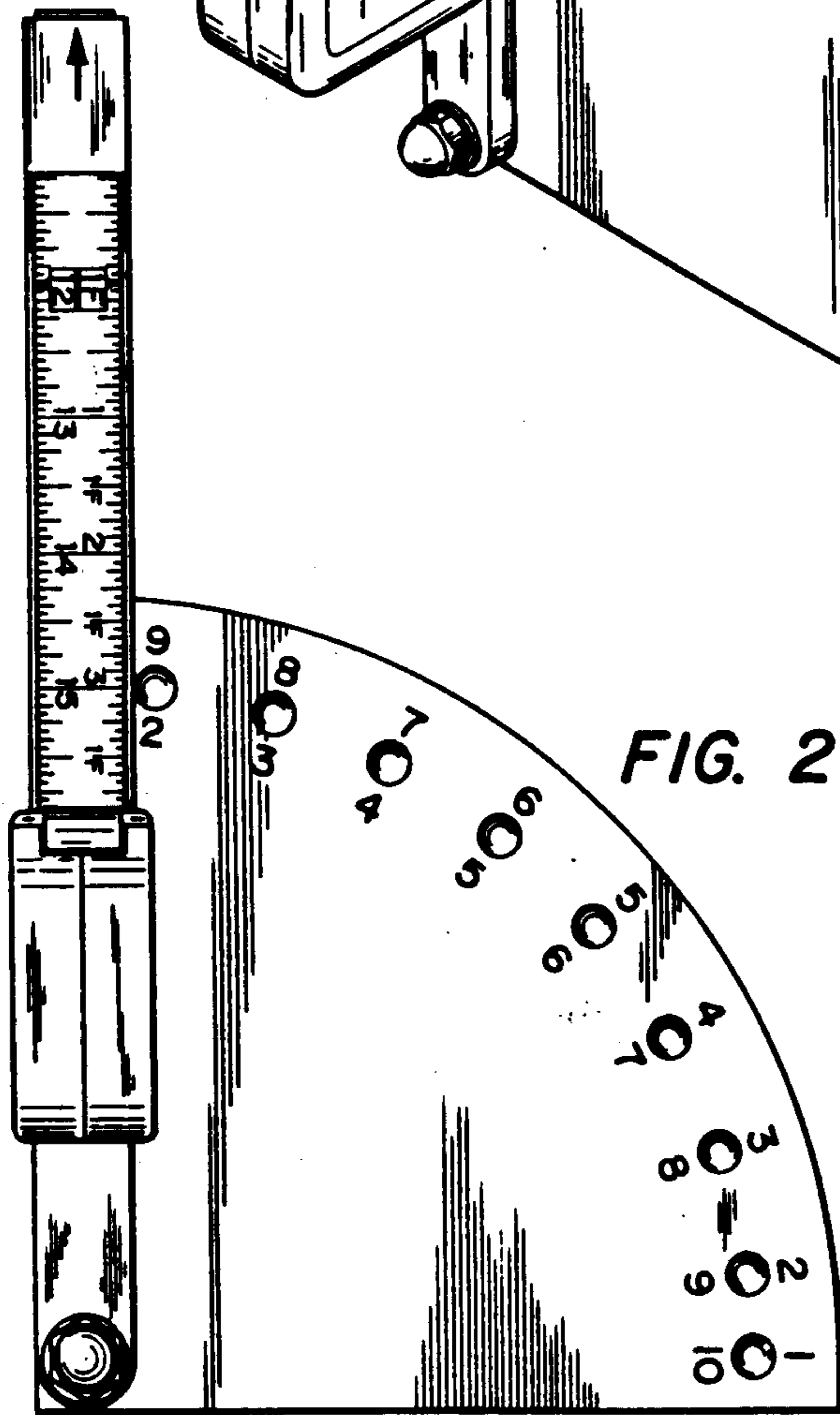
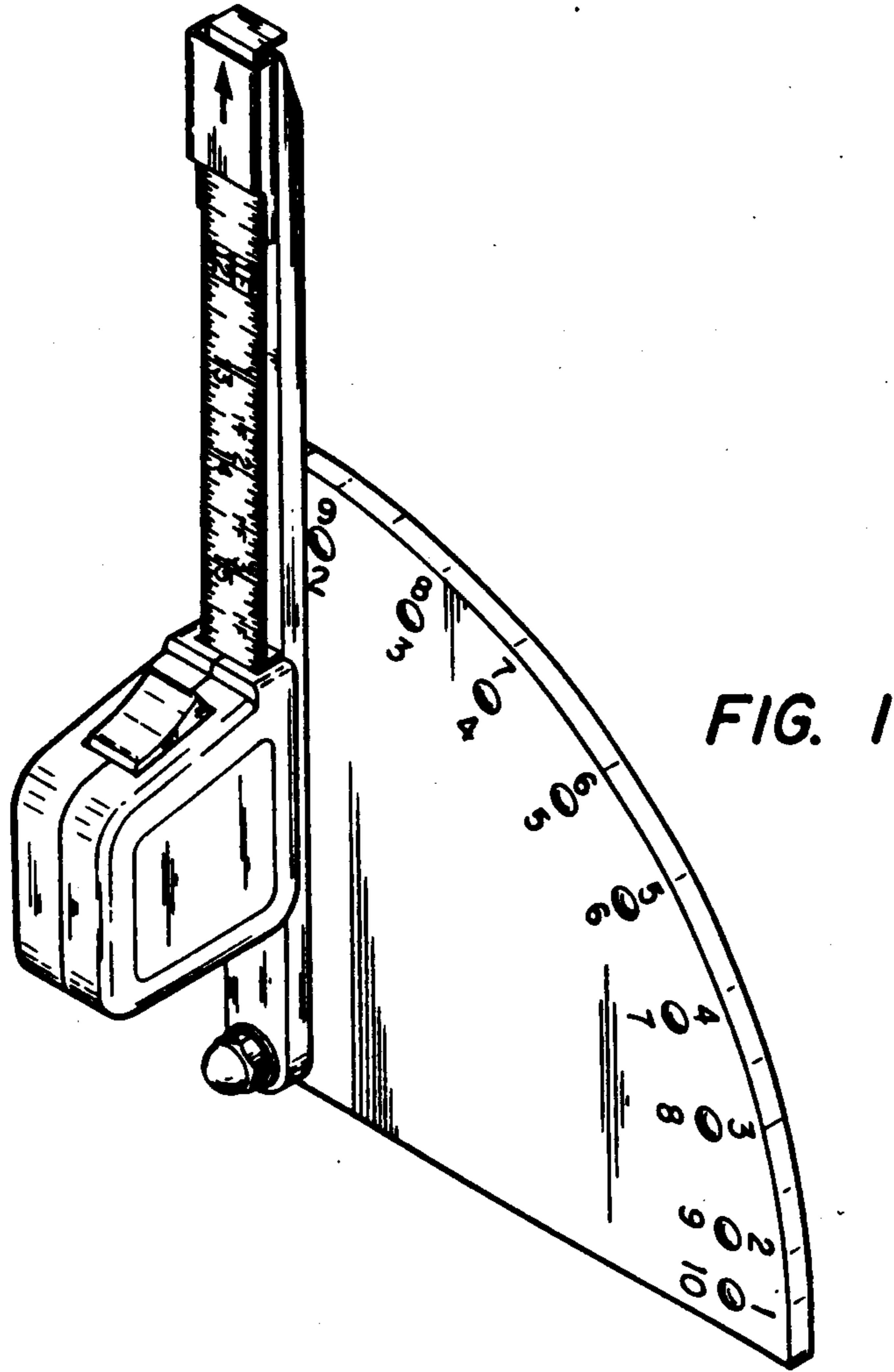

FIG. 4

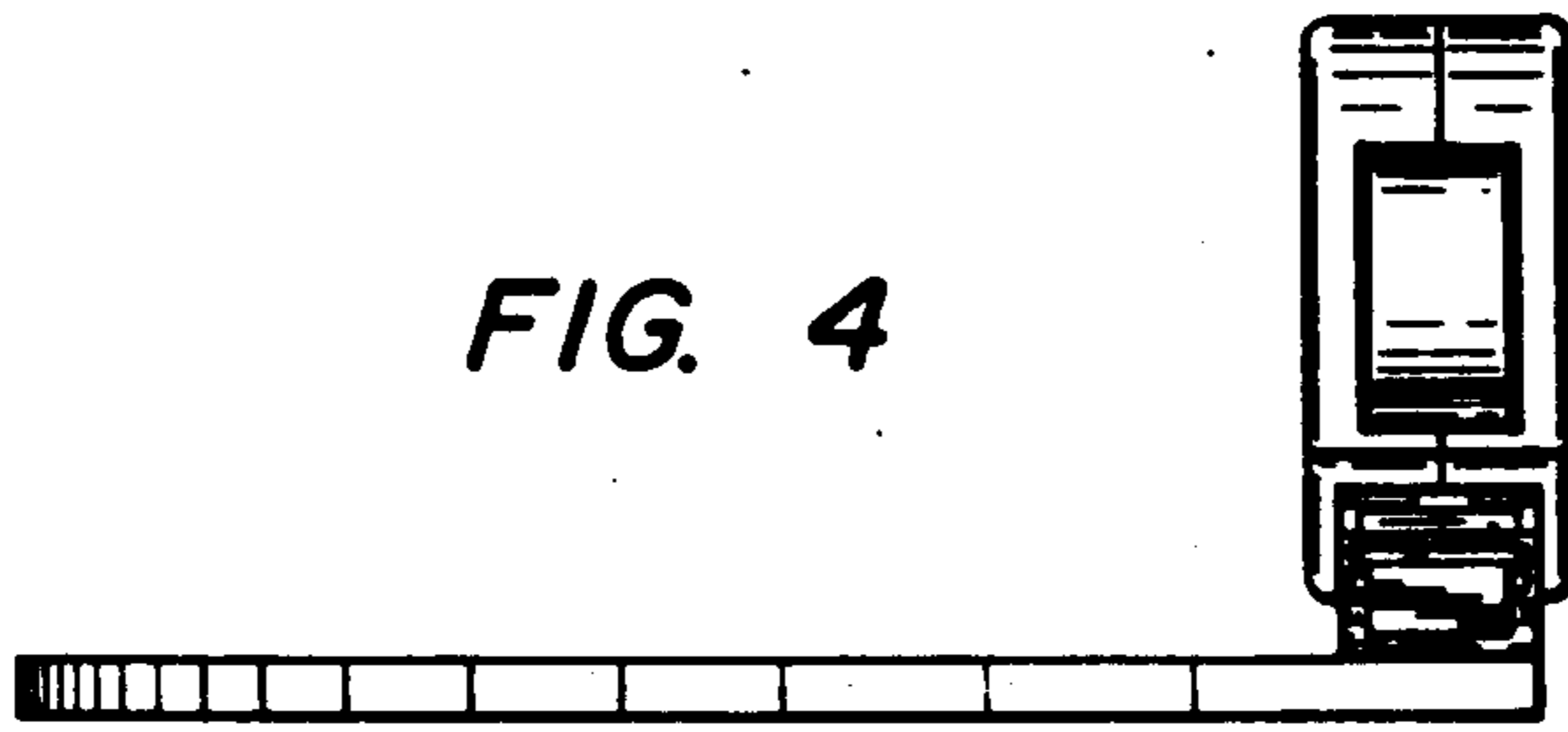

FIG. 5

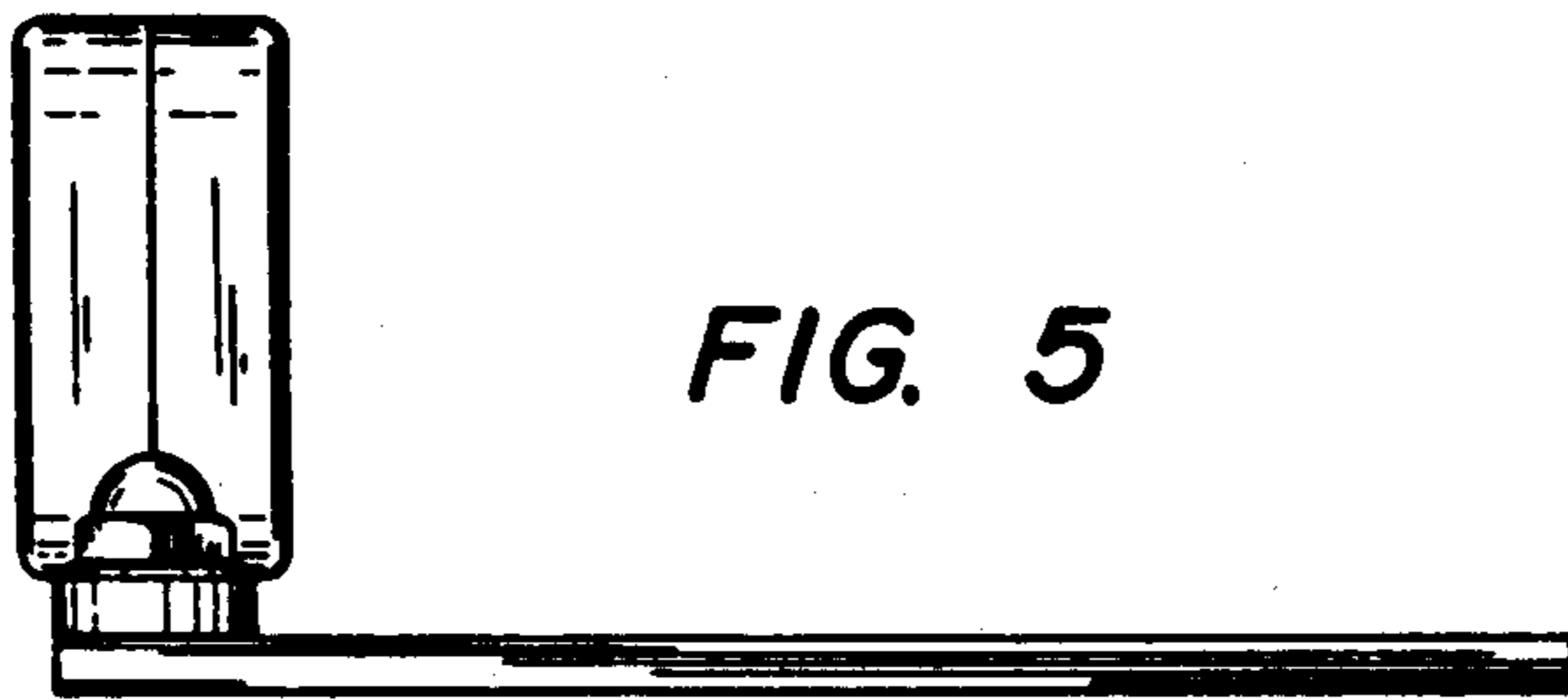

FIG. 6

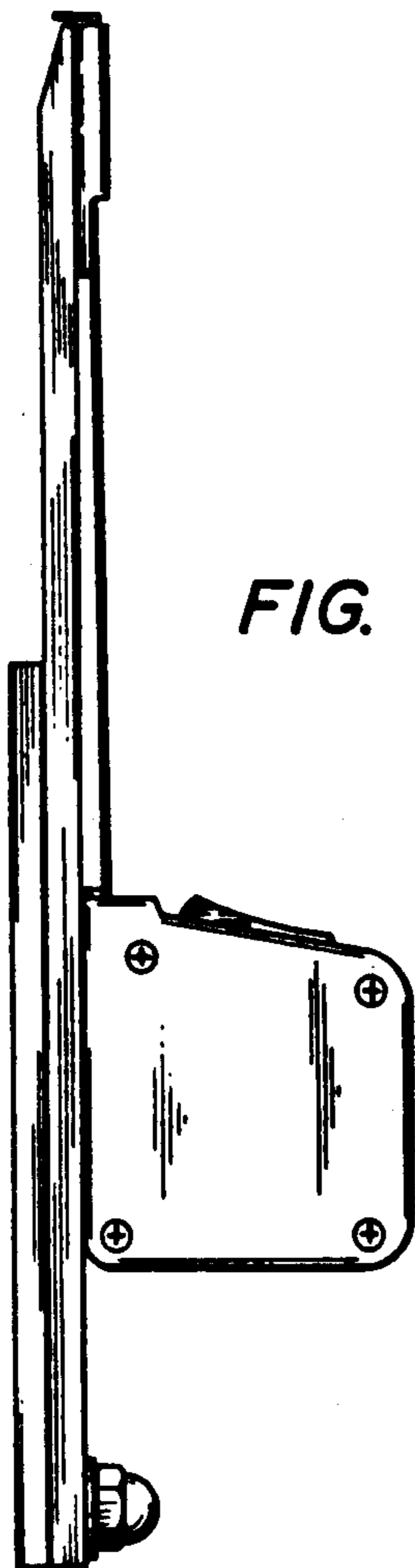

FIG. 7

