

[54] DISK FILE BOX

[76] Inventors: Bob Mervar, 1461 Brookville Ct., Columbus, Ohio 43229; Kent W. Murphy, 709 Bever St., Wooster, Ohio 44691; Charles W. Craft, Jr., 58 LeRue St., Apple Creek, Ohio 44606

[\*\*] Term: 14 Years

[21] Appl. No.: 208,636

[22] Filed: Jun. 20, 1988

[52] U.S. Cl. .... D3/35; D19/75; D19/76; D19/90

[58] Field of Search ..... D3/30.1, 35; D19/65, D19/75, 76, 78, 86, 90, 91, 95, 100; 206/215, 425, 371, 444, 449; 211/11, 40, 50; 312/13

[56] References Cited

U.S. PATENT DOCUMENTS

D. 267,911	2/1983	Long et al. ....	D3/35
D. 282,313	1/1986	Long et al. ....	D3/35
D. 285,214	8/1986	Roskvist .....	D19/76
D. 285,216	8/1986	Roskvist .....	D19/76
D. 287,068	12/1986	Long et al. ....	D3/35
D. 287,544	1/1987	Long et al. ....	D3/35
D. 293,279	12/1987	Evans .....	D3/35
D. 293,625	1/1988	Bankier .....	D3/35
D. 297,072	8/1988	Drake et al. ....	D3/35
4,848,574	7/1989	Murphy et al. ....	206/444

OTHER PUBLICATIONS

P. 20, Eldon Office Products, 1130 E. 230th St., Carson, Calif. 90745-5094, publication date unknown.

P. 122, Straucks Stations, 12 W. Main St., Mesa, Ariz., publication date unknown.

Catalog page, MicroComputer Accessories, Inc., 5405 Jandy Pl., P.O. Box 66911, Los Angeles, Calif. 90066-0911, publication date 1986.

Sell sheet, Evco Computer Products, 7151 Evco Cir., DeForest, Wis. 53537, publication date unknown.

Catalog page, Sterling Plastics, Sheffield St., Mountain-side, N.J. 07092, publication date unknown.

Catalog page, Eichner Systems, address unknown, publication date unknown.

Primary Examiner—Bruce W. Dunkins

Assistant Examiner—Martha Thompson

[57] CLAIM

The ornamental design for a disk file box, as shown and described.

DESCRIPTION

FIG. 1 is a front perspective view of a disk file box showing our new design.

FIG. 2 is a left side elevational view, the right side being a mirror image thereof;

FIG. 3 is a top plan view;

FIG. 4 is a bottom plan view;

FIG. 5 is a front elevational view; and

FIG. 6 is a rear elevational view thereof.

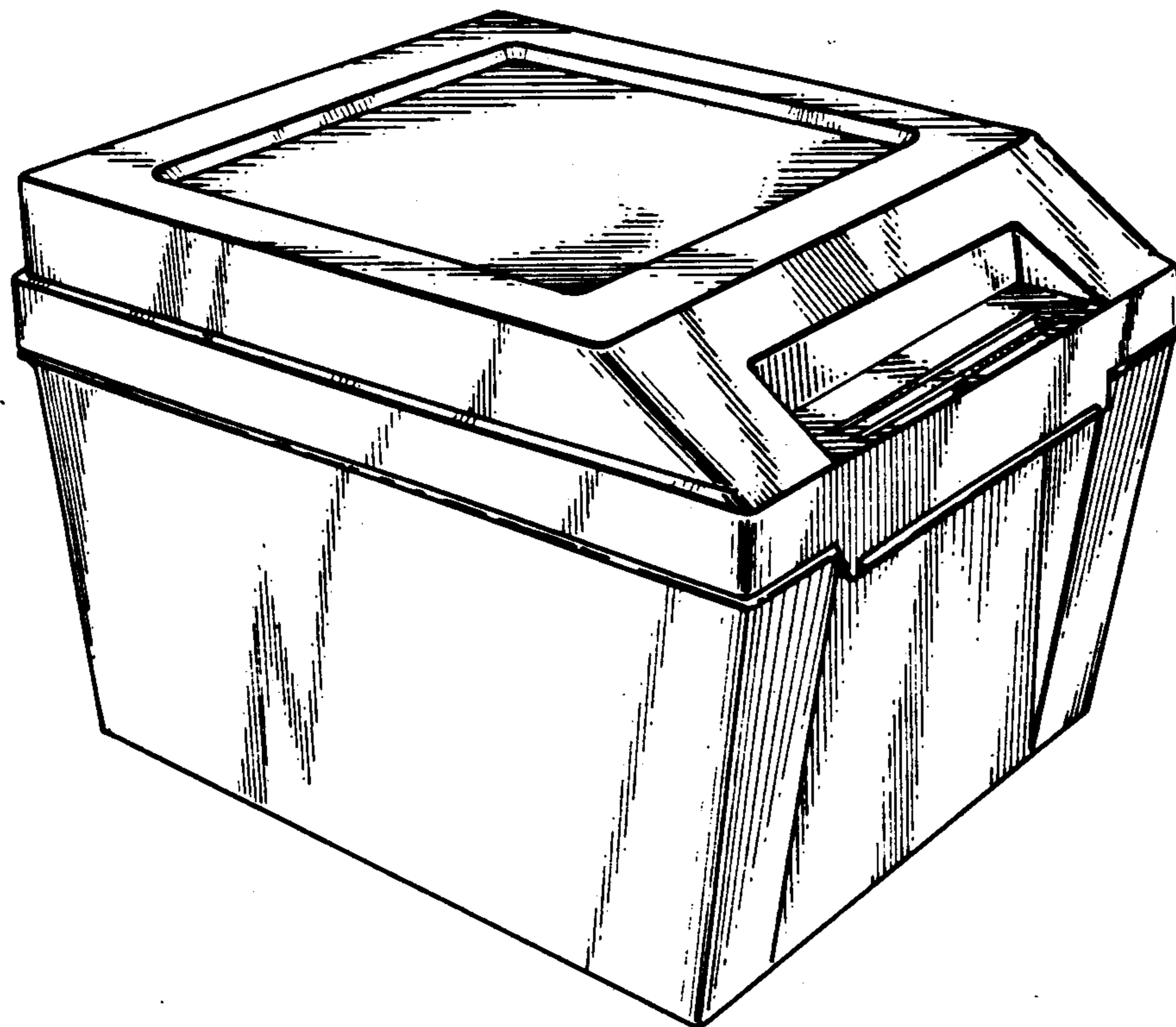

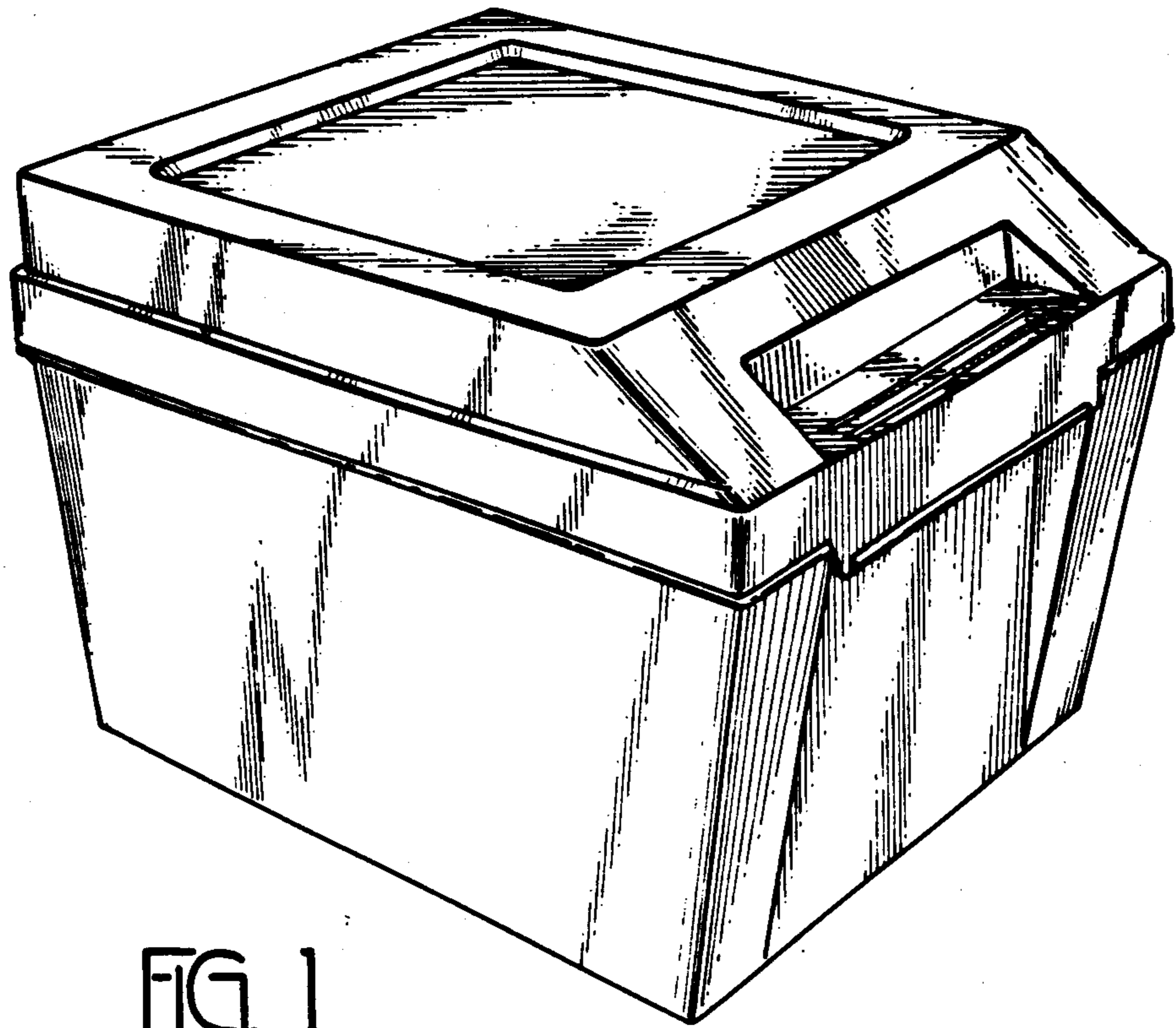

FIG. 1

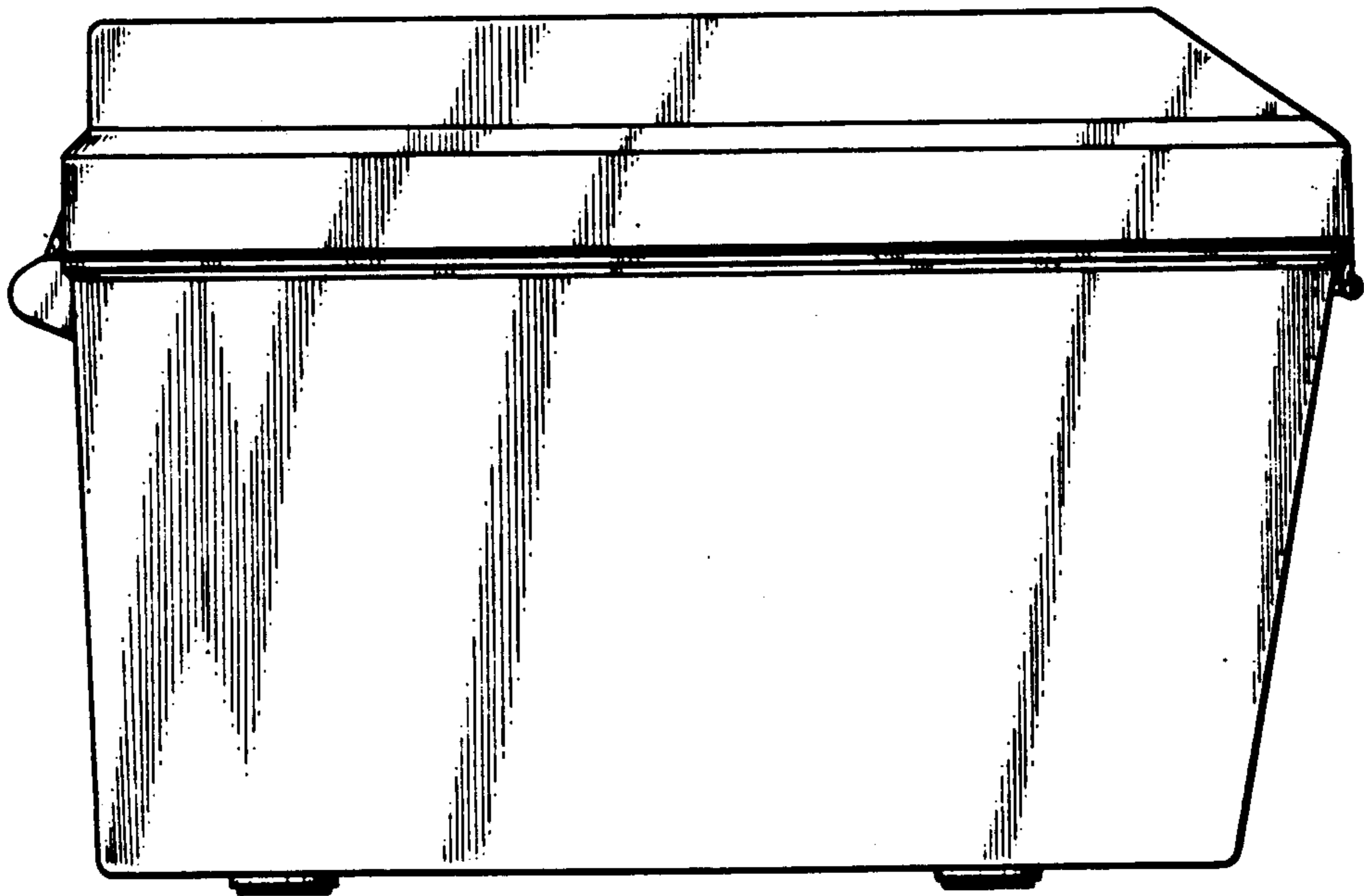

FIG. 2

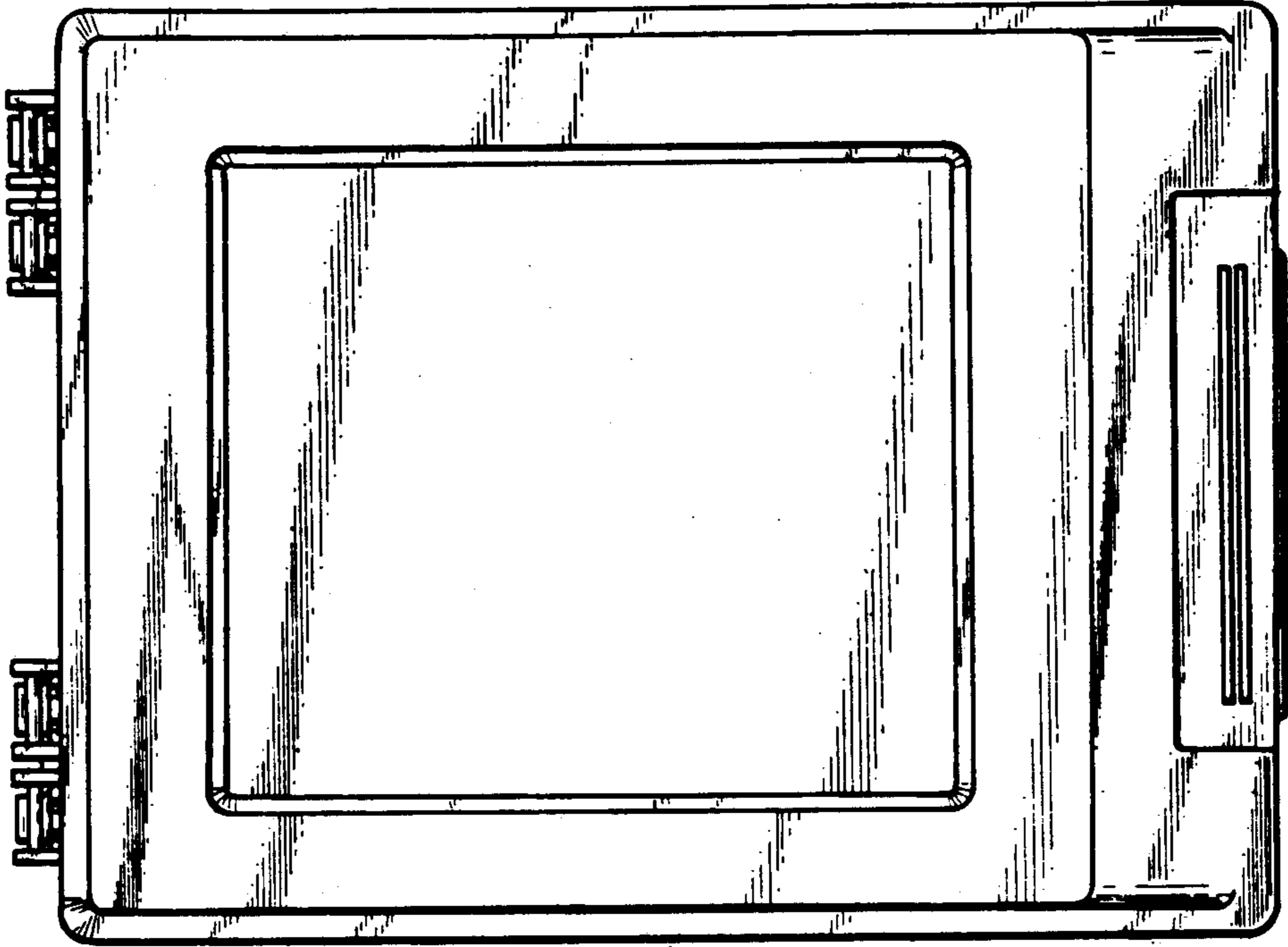

FIG. 3

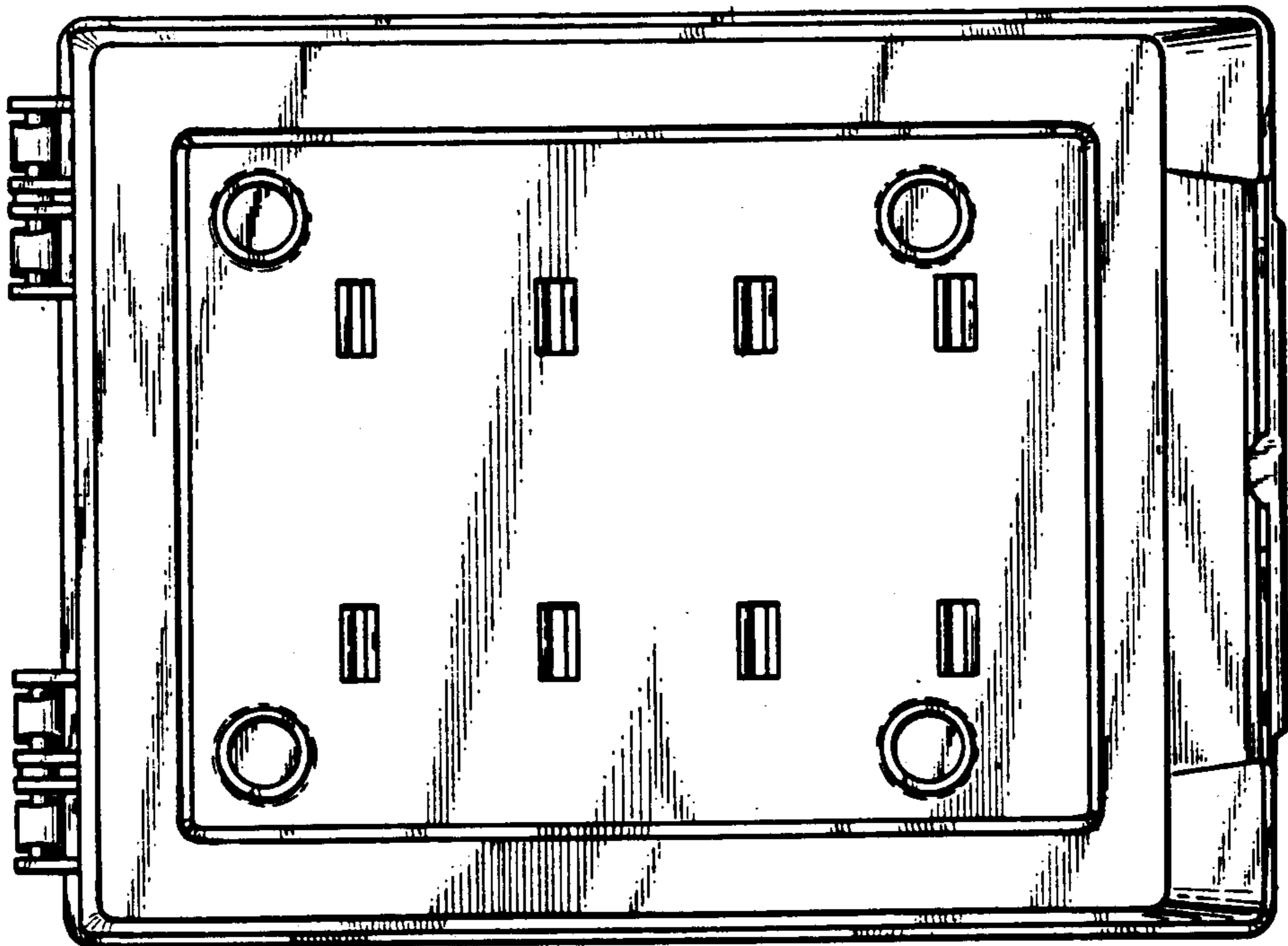

FIG. 4

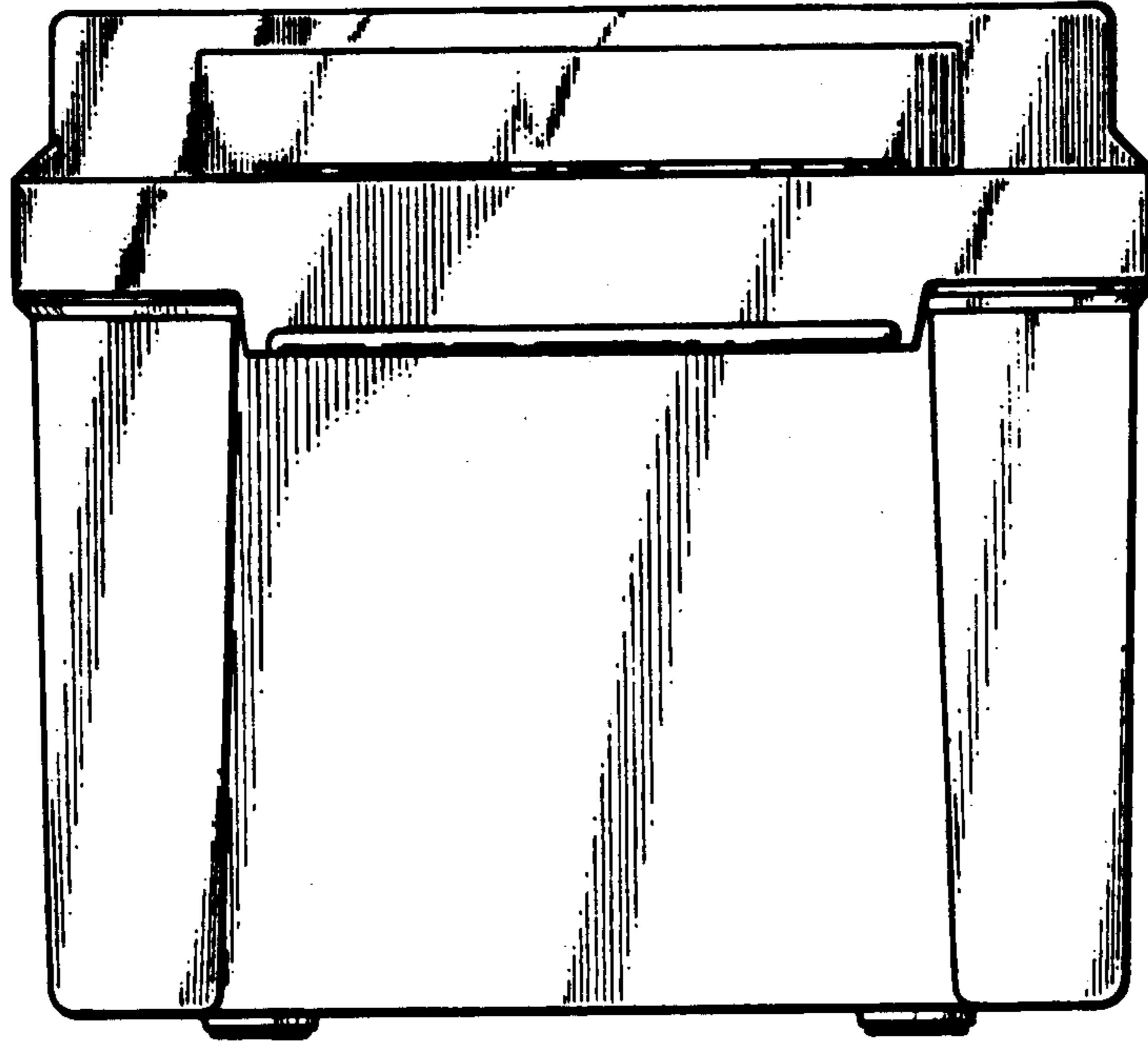

FIG. 5

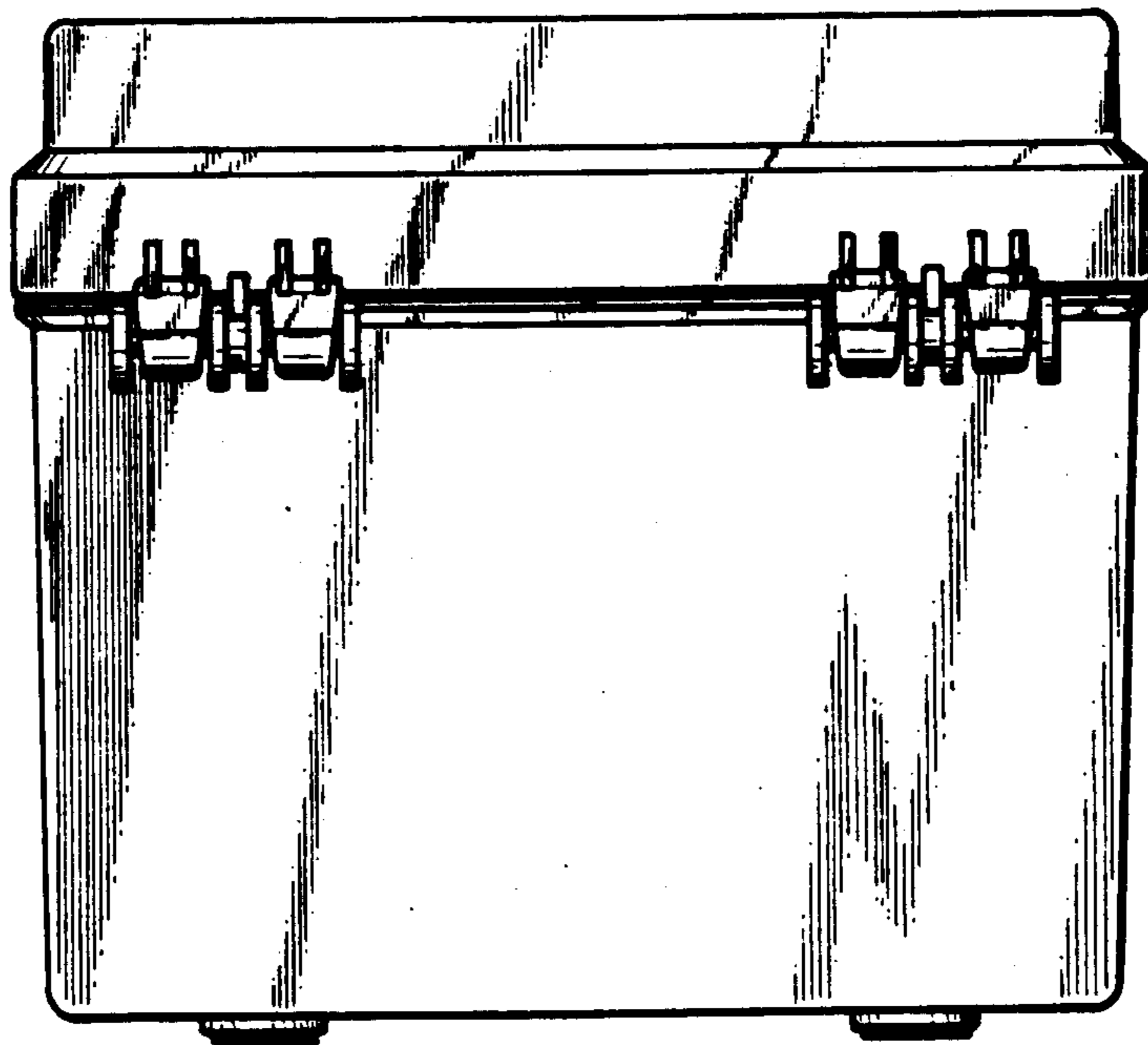

FIG. 6