

[54] WALL-MOUNTED CONTAINER

[75] Inventor: Paul E. Delmerico, Winchester, Va.

[73] Assignee: Rubbermaid Commercial Products Inc., Winchester, Va.

[\*\*] Term: 14 Years

[21] Appl. No.: 316,678

[22] Filed: Feb. 28, 1989

[52] U.S. Cl. .... D34/7; D34/8

[58] Field of Search ..... D34/1, 7, 8, 9;  
220/908, 909, 910, 94 R; 232/1 R

[56] References Cited

U.S. PATENT DOCUMENTS

- D. 233,127 10/1974 Karn, Jr. .
- D. 256,089 7/1980 Adamson ..... D34/8
- D. 280,459 9/1985 McClelland ..... D34/8
- D. 296,142 6/1988 Adamson ..... D34/7

OTHER PUBLICATIONS

Page 9, Continental MFG Company, A Division of Contico International Inc., 123 Byassee Dr., St. Louis, Mo. 63042. Publication date 1987.

Sell Sheet, Excell Metal Products, street address unknown, Chicago, Ill. 60647. Publication date 1987.

Page 16, United Metal Receptacle Corp., 14th and Laurel Sts., Pottsville, Pa. 17901-0870. Publication date 1987.

Page 2, F. H. Lawson Co., 801 Evans St., Cincinnati, Ohio 45204. Publication date 1987.

Page 8, Rubbermaid Commercial Products Inc., 3124 Valley Ave., Winchester, Va. 22601. Publication date 1988.

Primary Examiner—Kay H. Chin

Attorney, Agent, or Firm—Richard B. O'Planick

[57] CLAIM

The ornamental design for a wall-mounted container, as shown and described.

DESCRIPTION

FIG. 1 is a top and front perspective view of a wall-mounted container showing my new design;

FIG. 2 is a front elevational view thereof.

FIG. 3 is a rear elevational view thereof.

FIG. 4 is a top plan view thereof.

FIG. 5 is a bottom plan view thereof.

FIG. 6 is a side elevational view thereof; the opposite side being a mirror image.

FIG. 7 is transverse sectional view thereof taken along the line 7-7 of FIG. 4.

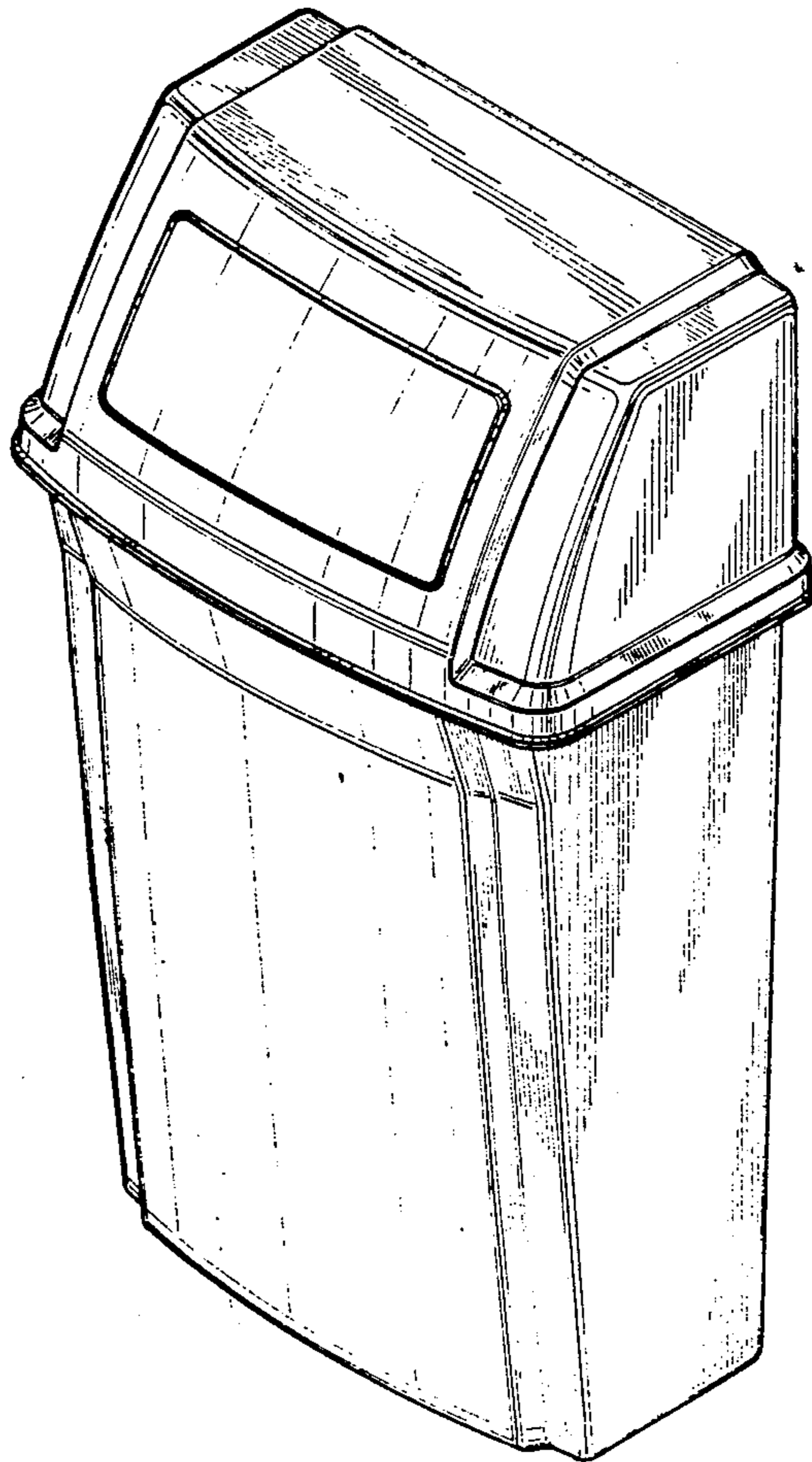

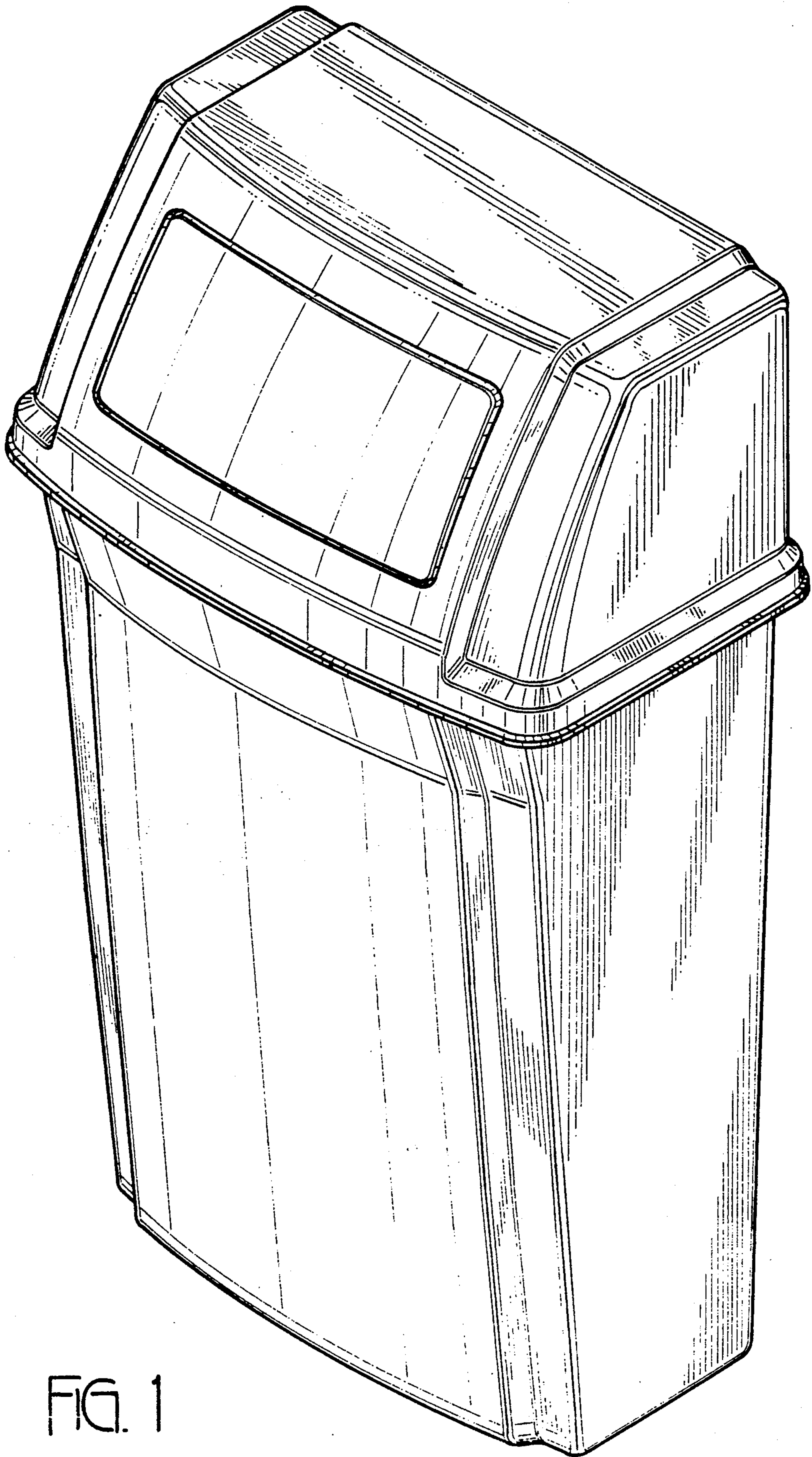

FIG. 1

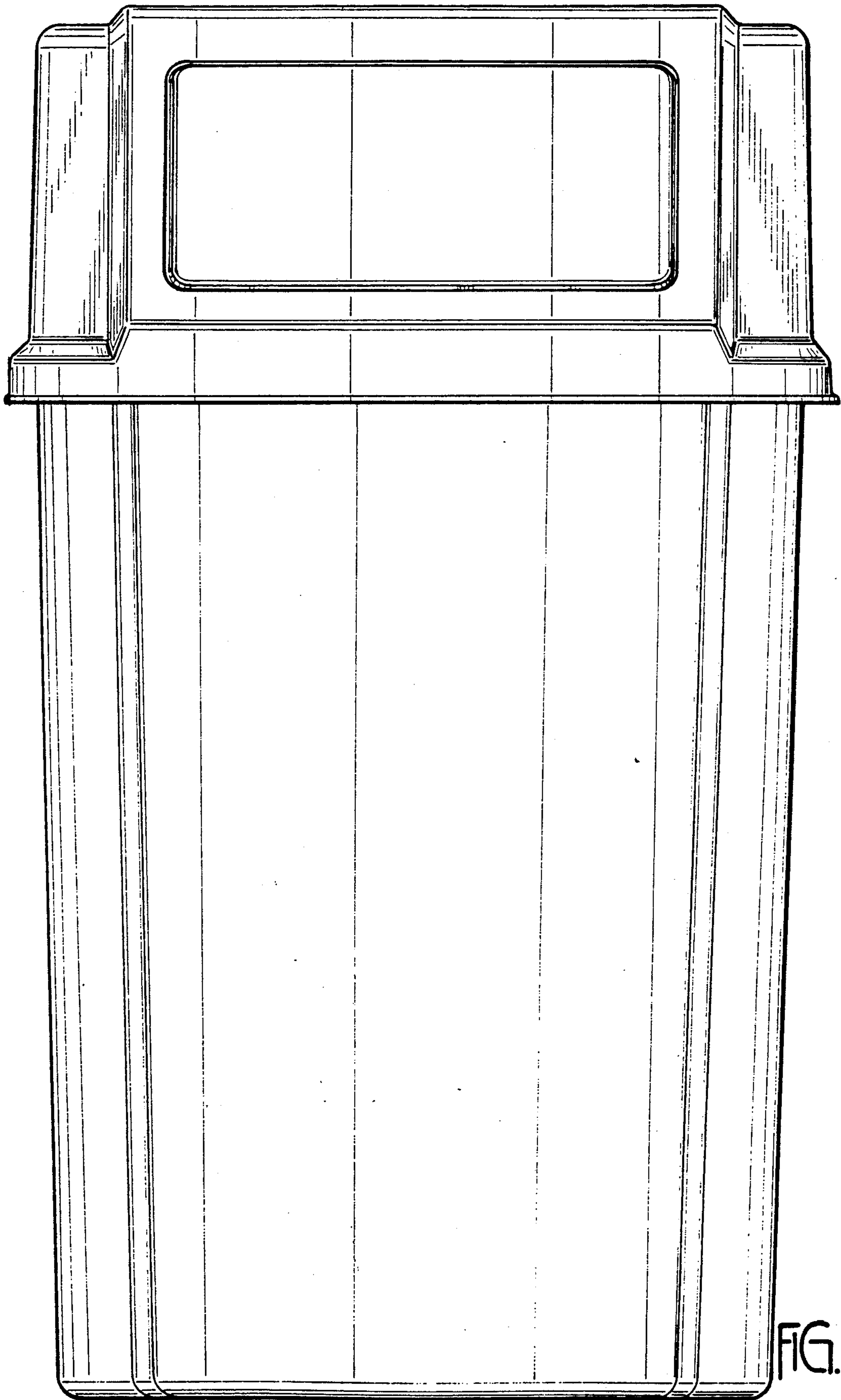

FIG. 2

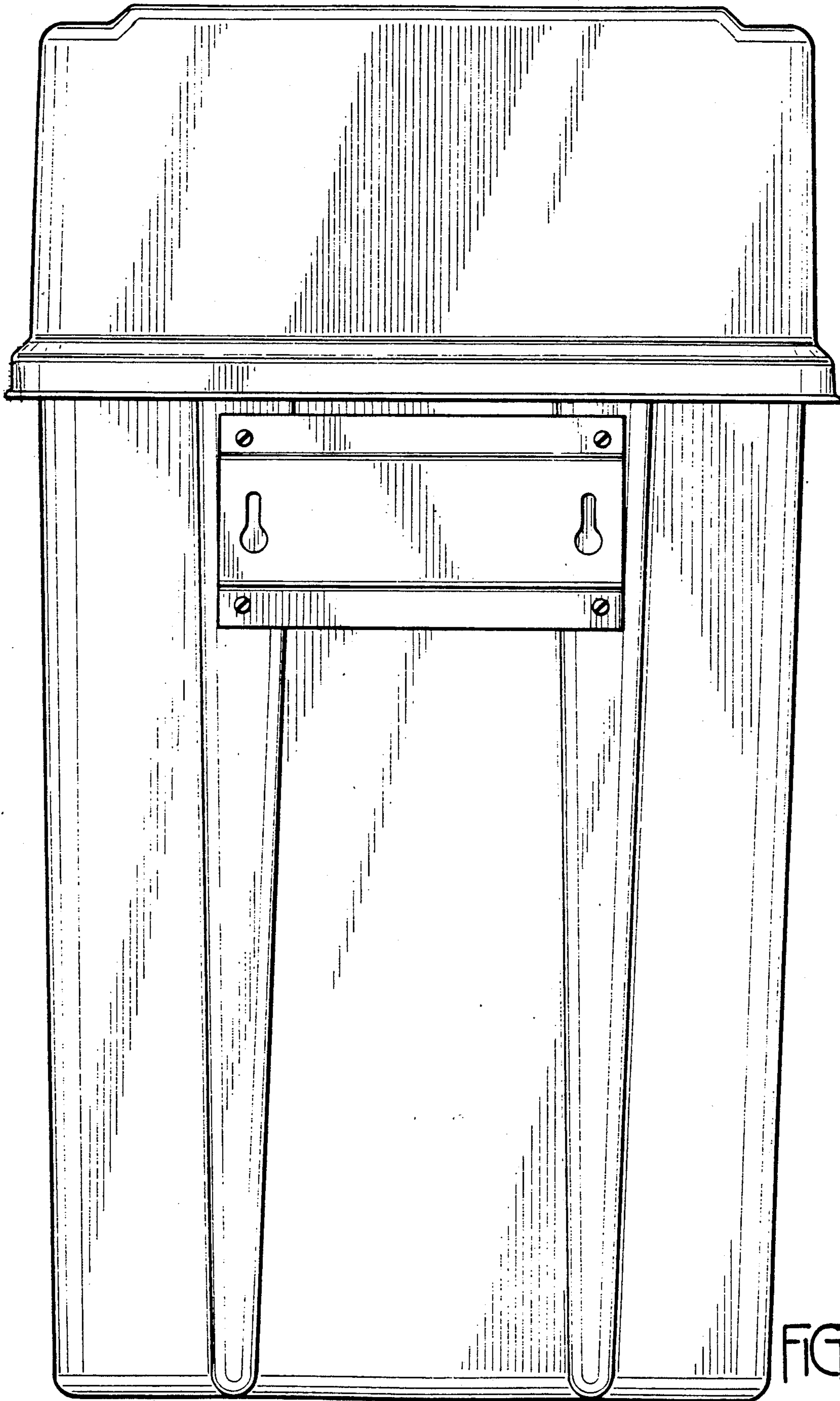
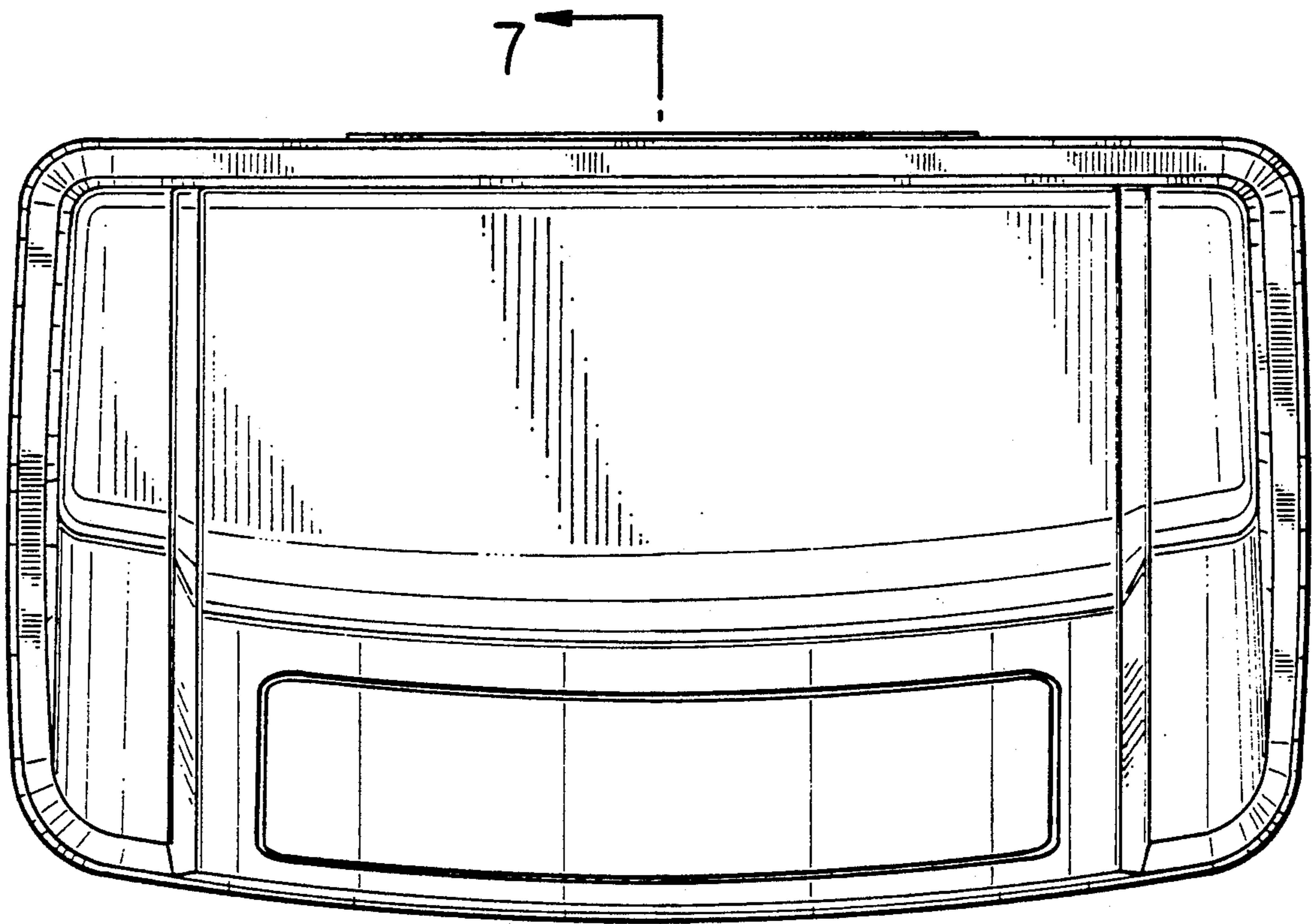

FIG. 3



7

FIG. 4

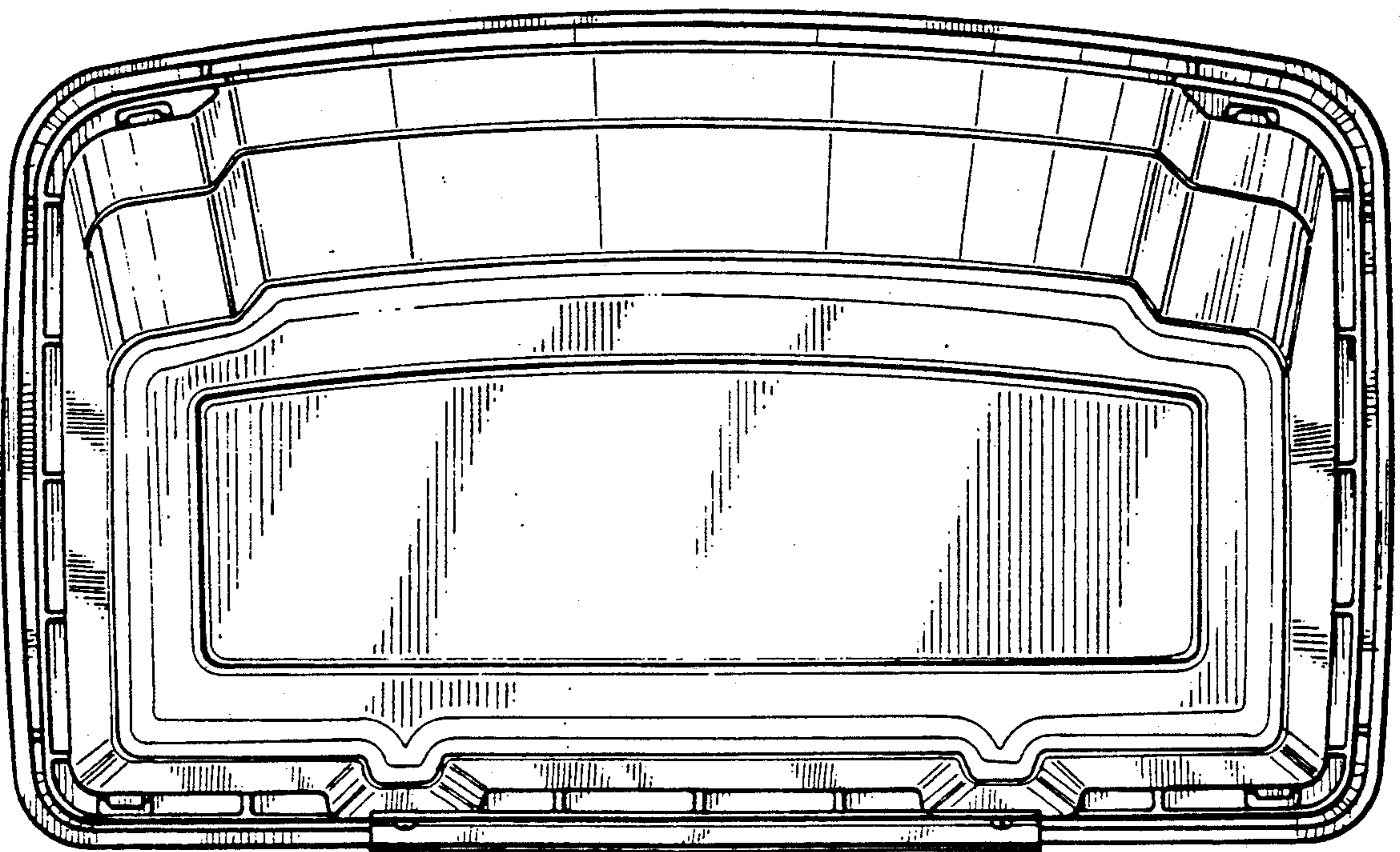

FIG. 5

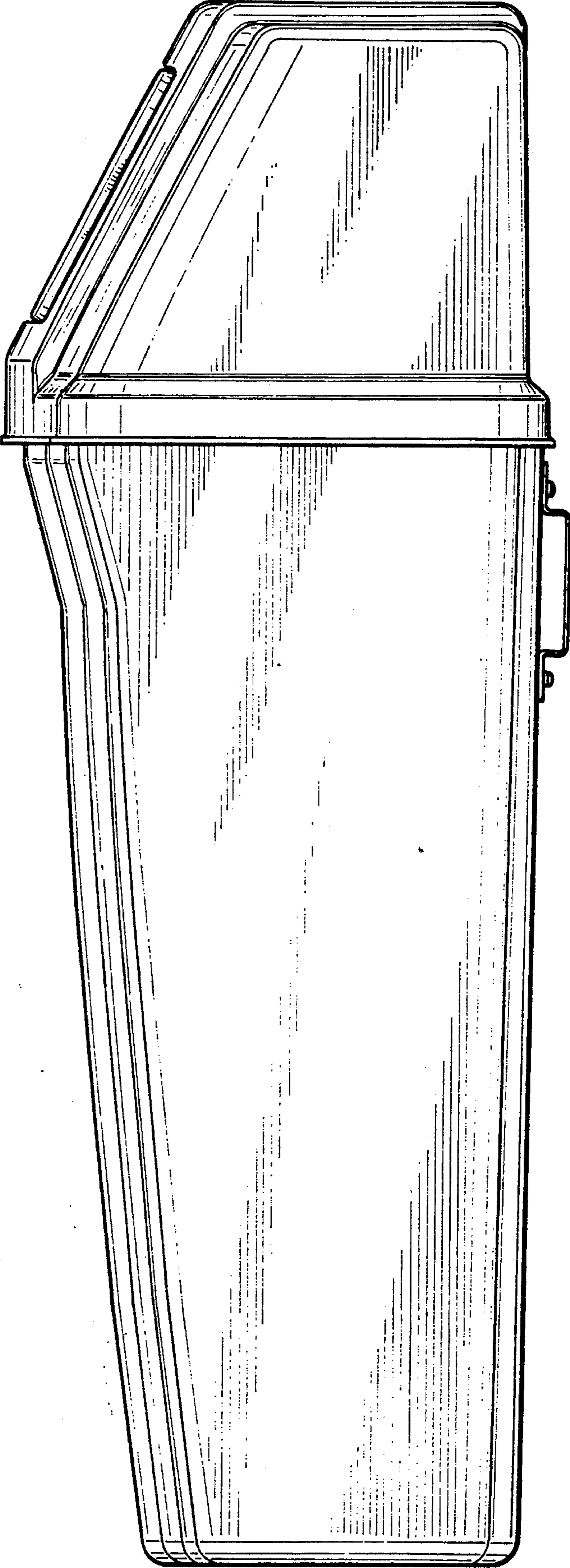

FIG. 6

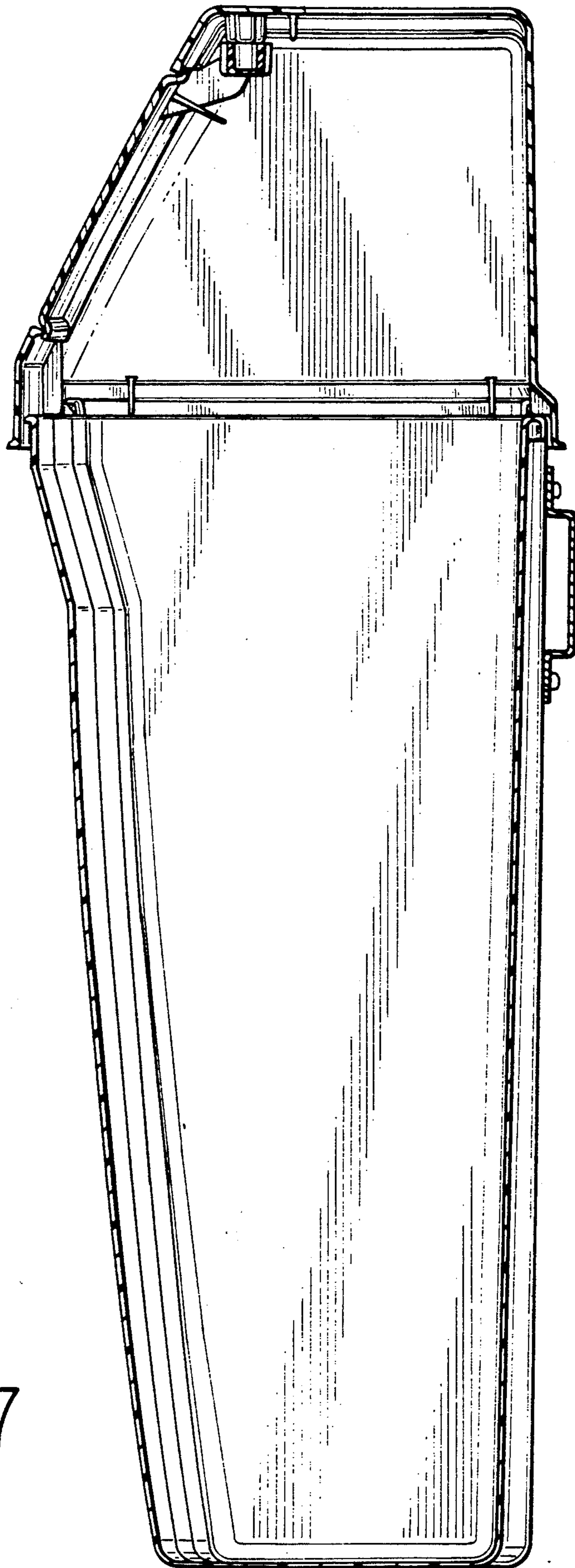

FIG. 7