

[54] DEPILATOR

[76] Inventor: Michel Challard, 74 rue du Faubourg
Saint Antoine, 75012 Paris, France

[**] Term: 14 Years

[21] Appl. No.: 364,611

[22] Filed: Jun. 9, 1989

[30] Foreign Application Priority Data

Dec. 14, 1988 [FR] France 88 7704

[52] U.S. Cl. D28/10; D28/49

[58] Field of Search D28/10, 49, 51-57,
D28/58; D24/23, 26, 28, 40, 41, 44; 606/133,
134, 135; 30/32, 34.05, 43, 43.5, 43.6, 43.91,
43.92, 43.93, 86, 90

[56] References Cited

U.S. PATENT DOCUMENTS

D. 179,193 11/1956 Ernest D28/51
D. 179,245 11/1956 Ernest D28/51
D. 277,549 2/1985 Martinez D9/300
D. 283,060 3/1986 Camens D28/51
D. 289,565 4/1987 Mann D28/10

D. 290,341 6/1987 Durand D9/384
3,220,109 11/1965 De Haan et al. 30/43.6 X
4,510,687 4/1985 Groothuis et al. 30/34.2

Primary Examiner—B. J. Bullock
Assistant Examiner—C. Tuttle
Attorney, Agent, or Firm—Michael J. Striker

[57] CLAIM

The ornamental design for depilator, as shown and described.

DESCRIPTION

FIG. 1 is a front elevational view of a depilator showing my new design;
FIG. 2 is an exploded front elevational view;
FIG. 3 is a right side elevational view thereof;
FIG. 4 is a left side elevational view in assembled condition;
FIG. 5 is a top plan view, shown with the cover removed for clarity of illustration;
FIG. 6 is a bottom plan view thereof;
FIG. 7 is a perspective view in the assembled condition; and
FIG. 8 is an exploded perspective view thereof.

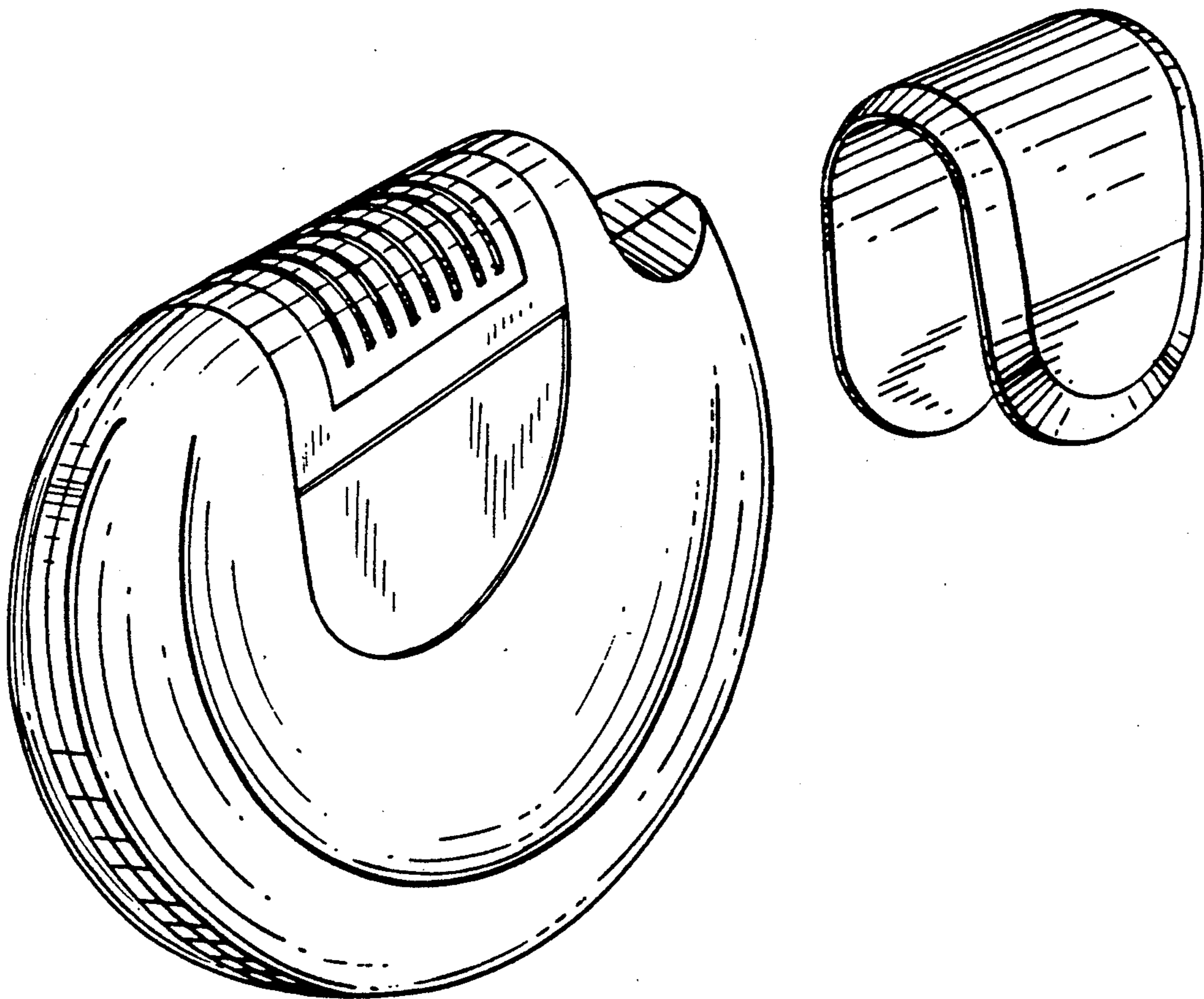

FIG. 1

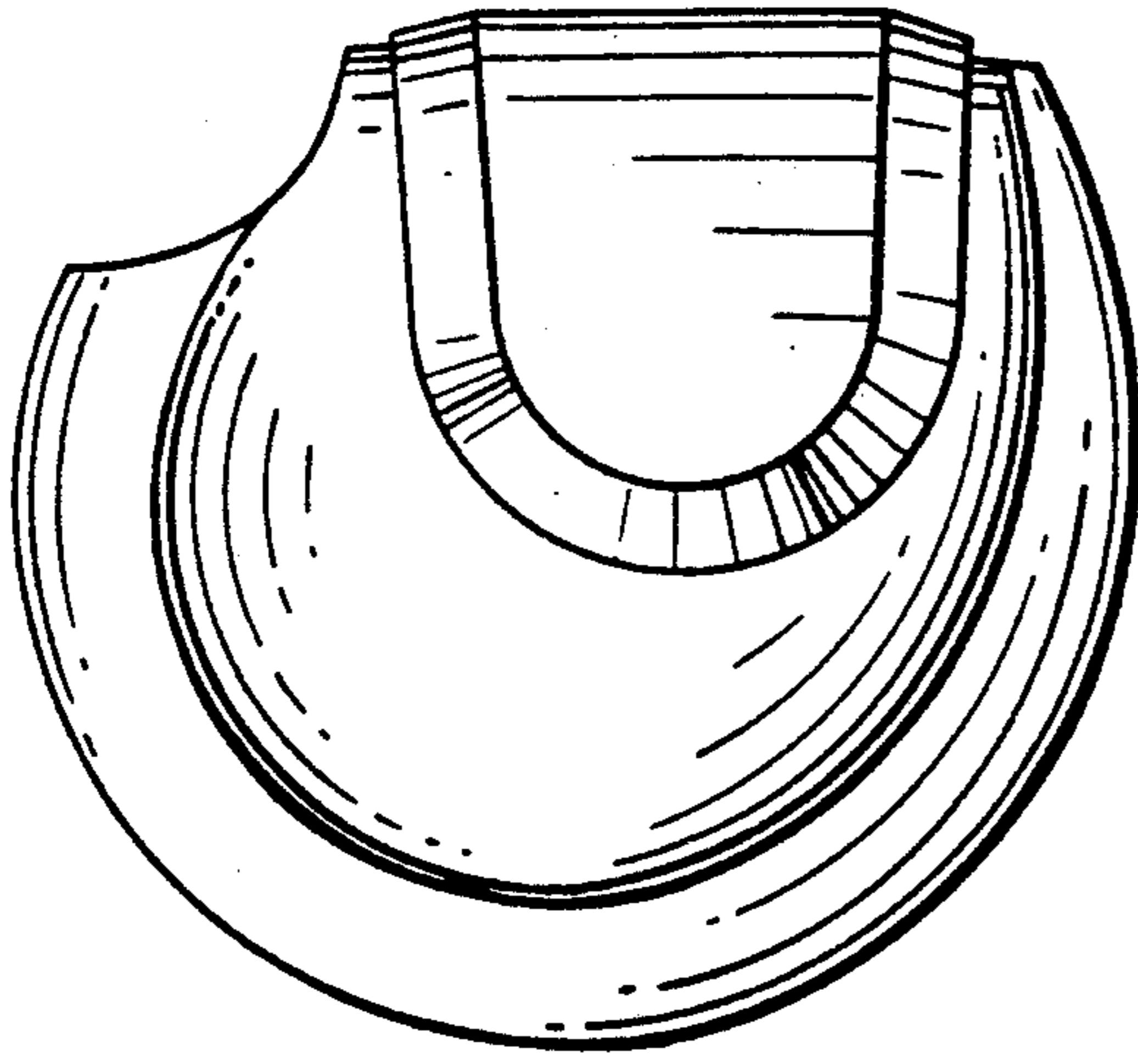

FIG. 4

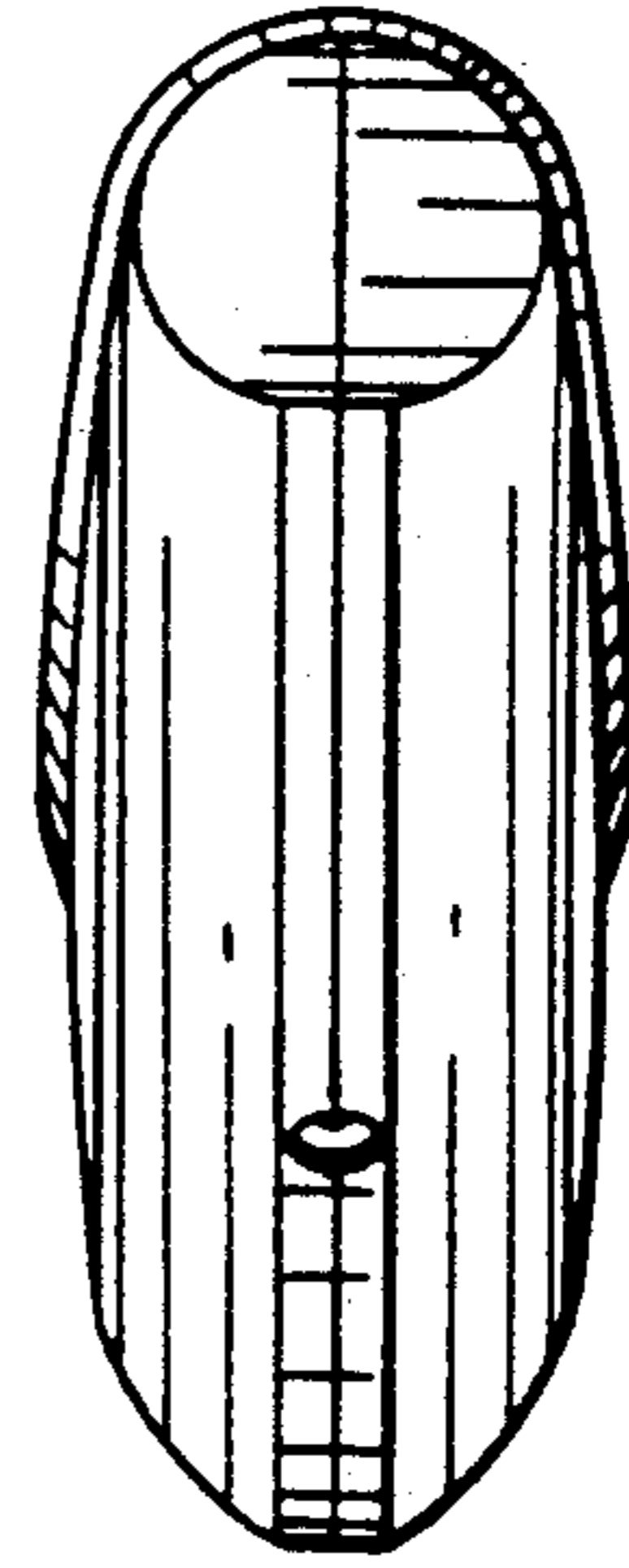

FIG. 2

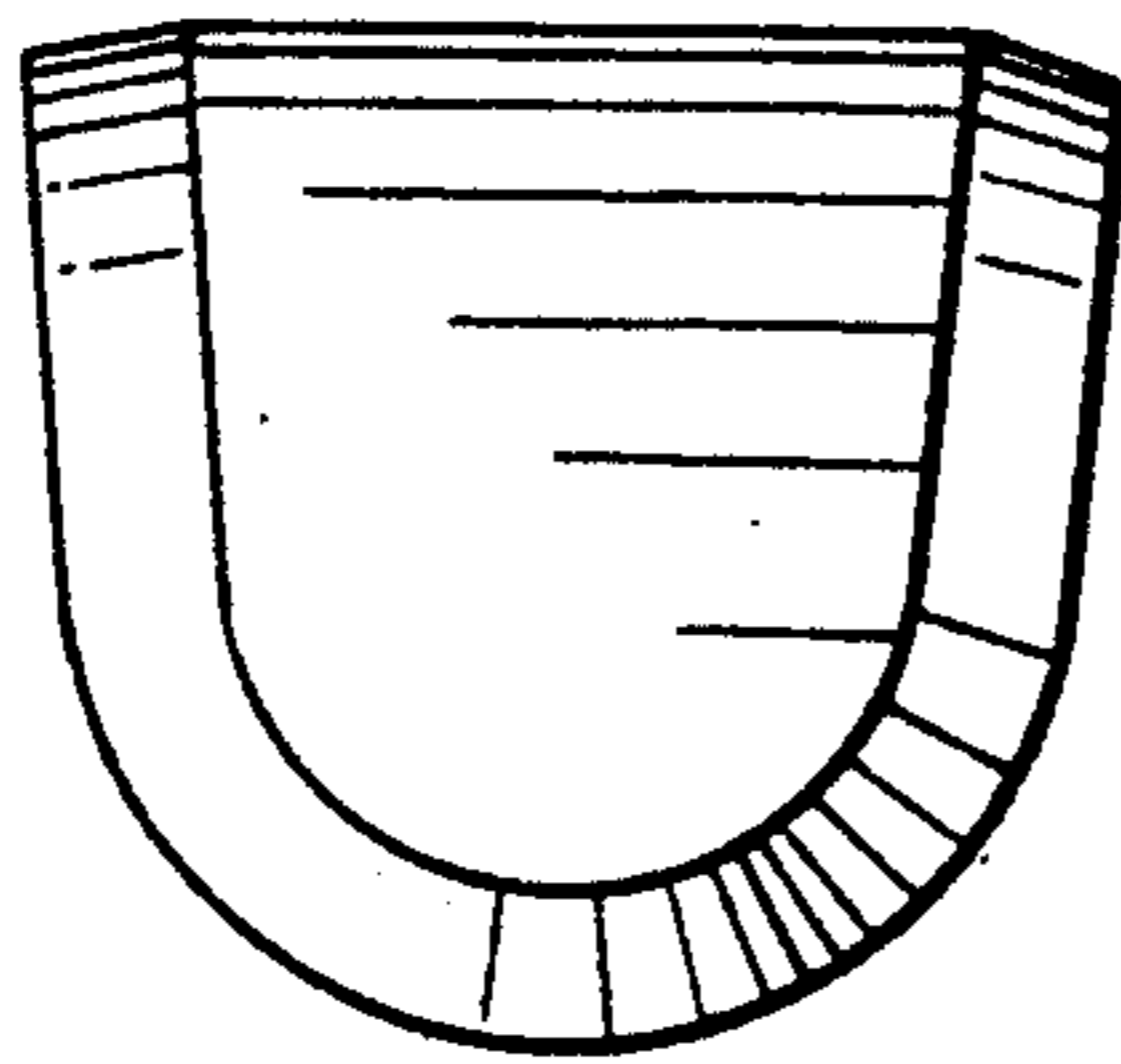

FIG. 3

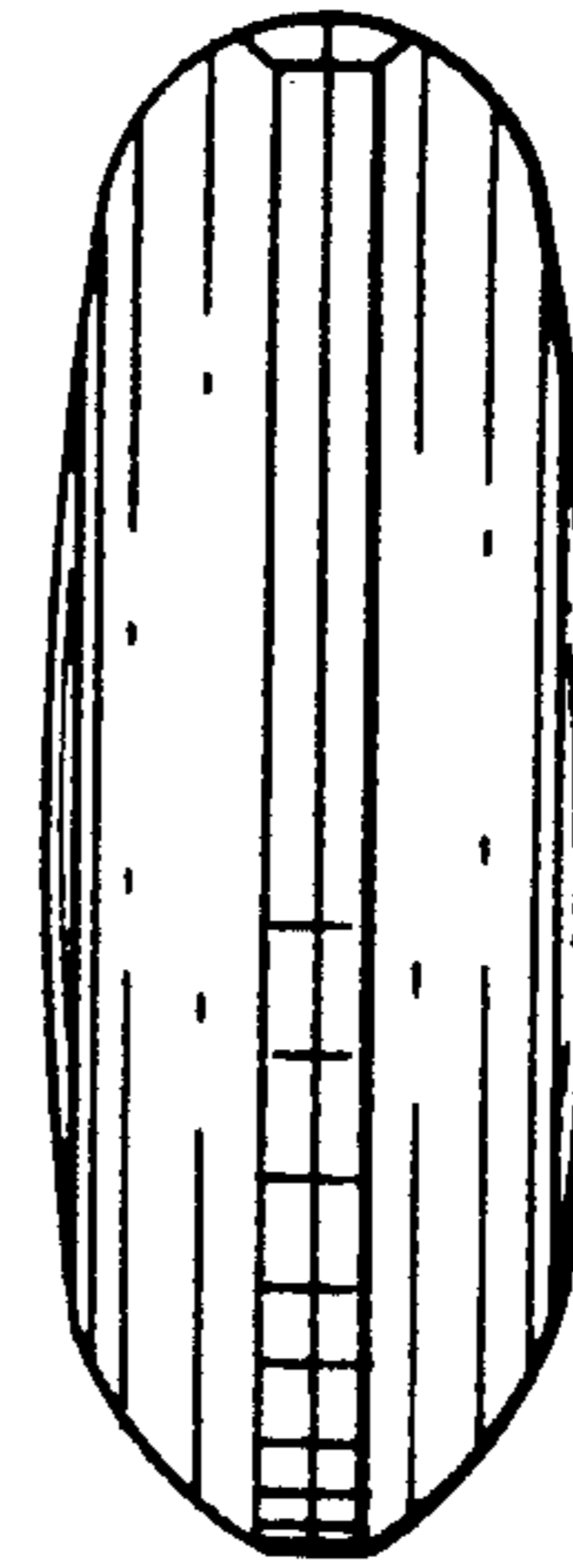
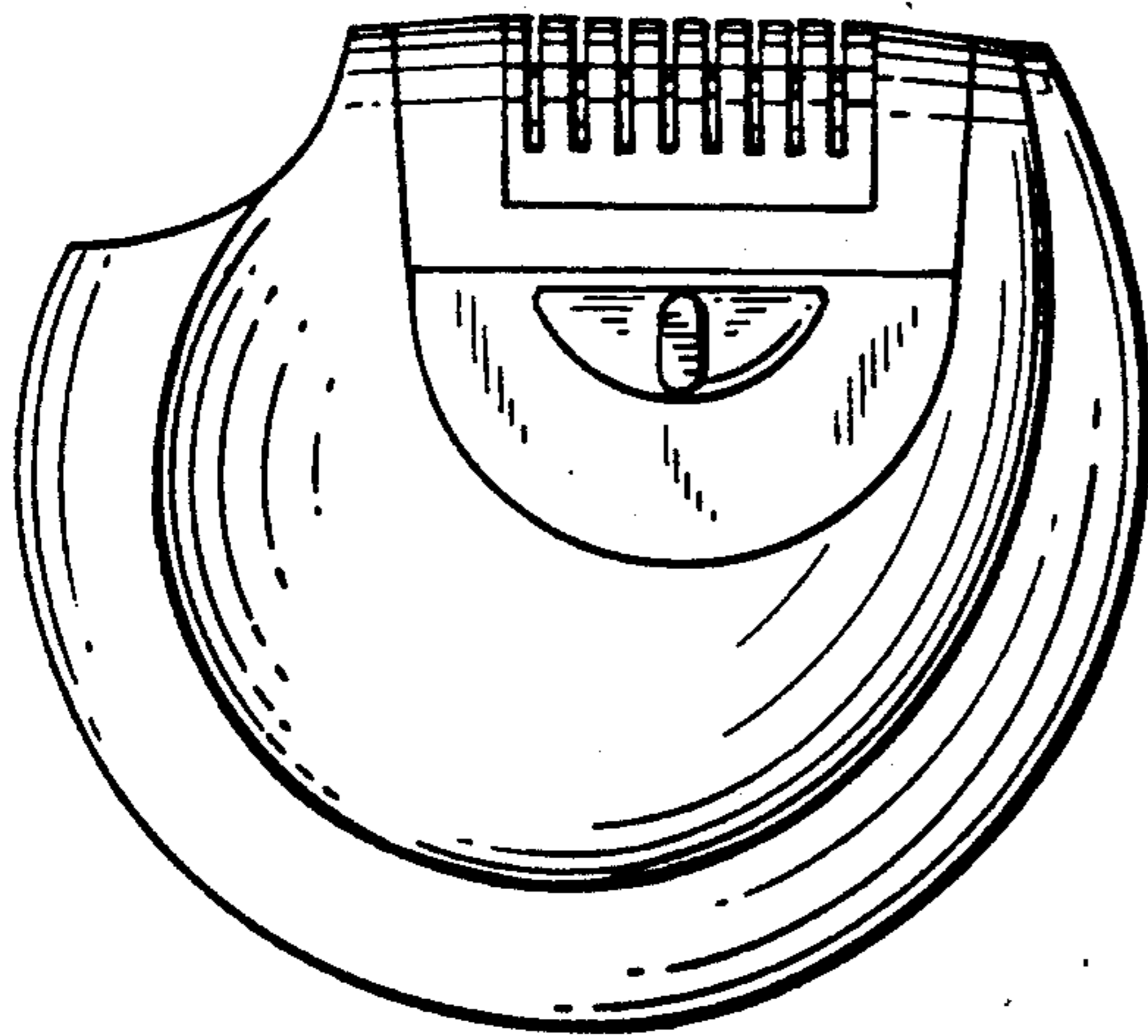
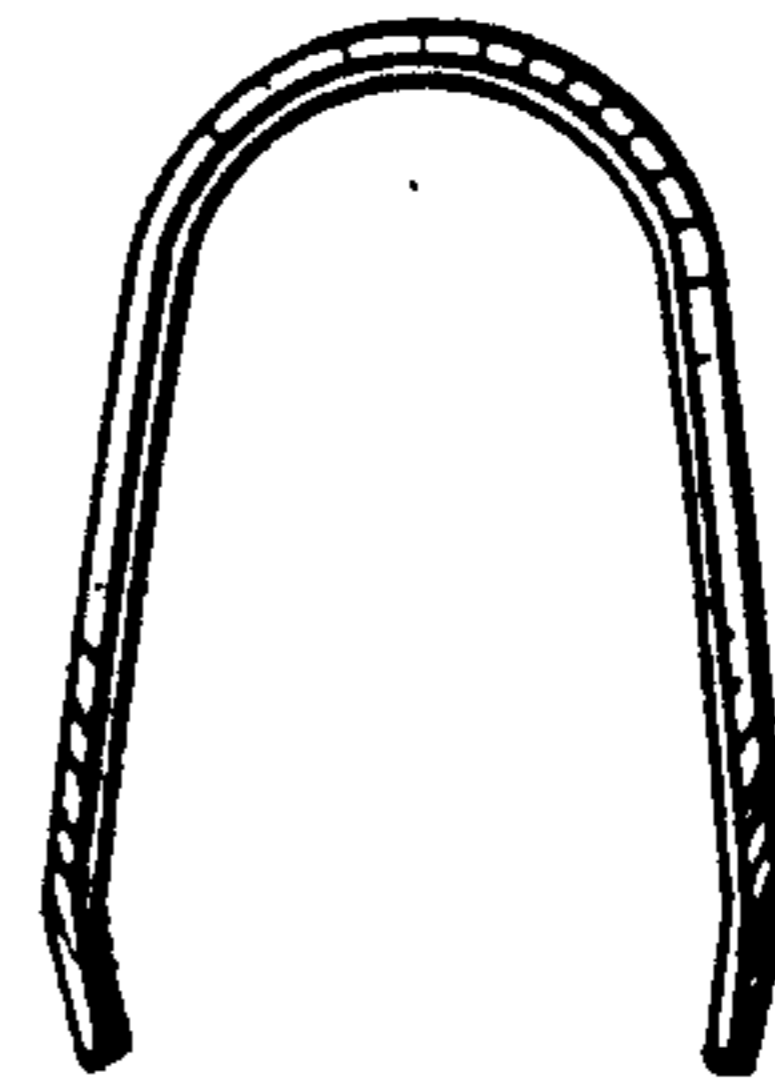

FIG. 5

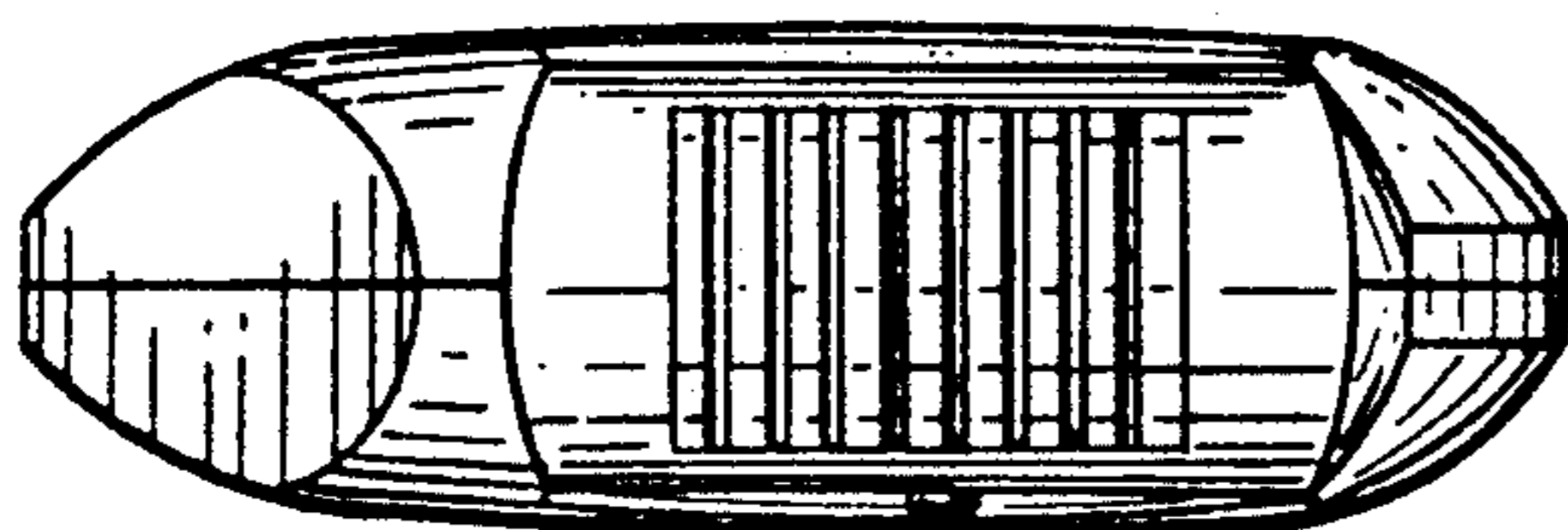

FIG. 6

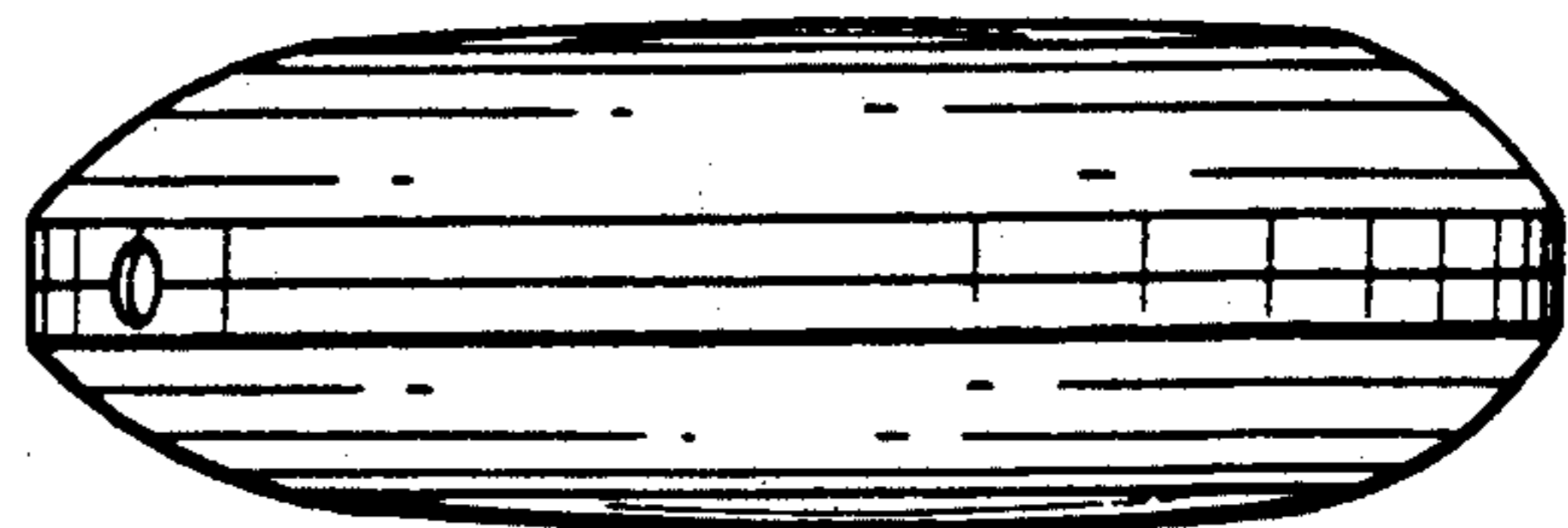

FIG. 7

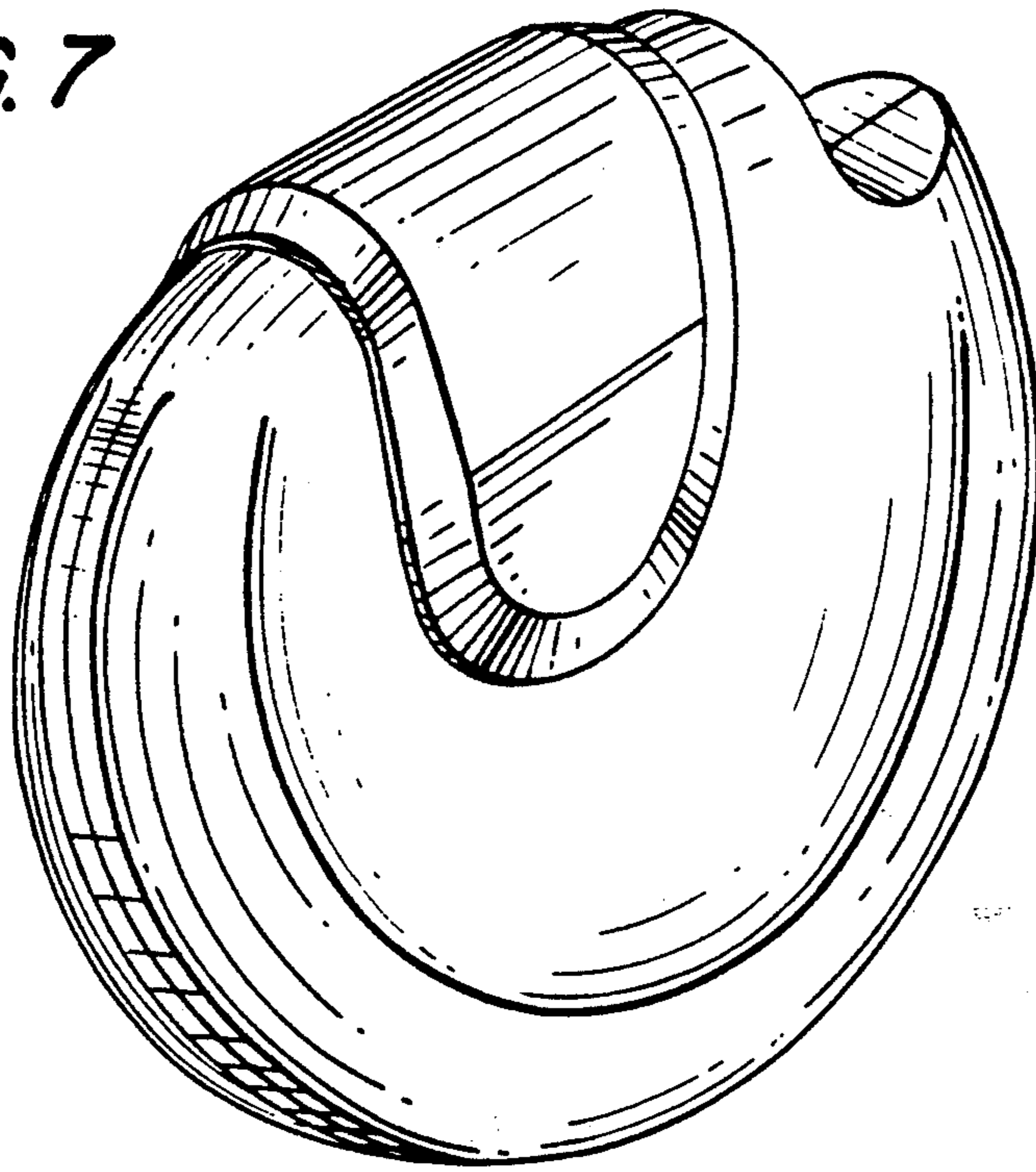

FIG. 8

