

[54] DIVER'S MASK

[75] Inventor: Hiromasa Sato, Tokyo, Japan

[73] Assignee: Tabata Co. Ltd., Tokyo, Japan

[**] Term: 14 Years

[21] Appl. No.: 78,701

[22] Filed: Jul. 28, 1987

[52] U.S. Cl. D16/102

[58] Field of Search D16/102, 107; D29/9

[56] References Cited

U.S. PATENT DOCUMENTS

- D. 143,077 7/1945 Kimball D16/102
- D. 266,031 9/1982 Sato D29/9
- D. 292,329 10/1987 Vitaloni D29/9
- 2,368,303 9/1940 Johnston D16/107 X

Primary Examiner—Bruce W. Dunkins

Assistant Examiner—M. Hannon

Attorney, Agent, or Firm—Fred Philpitt

[57] CLAIM

The ornamental design for a diver's mask, as shown and described.

DESCRIPTION

FIG. 1 is a front perspective view of a diver's mask showing my design;

FIG. 2 is a rear perspective view thereof;

FIG. 3 is a front elevational view thereof;

FIG. 4 is a rear elevational view thereof;

FIG. 5 is a side elevational view, the opposite side being a mirror image thereof;

FIG. 6 is a sectional view taken along the line 6—6 in FIG. 3;

FIG. 7 is a top plan view and

FIG. 8 is a bottom plan view thereof.

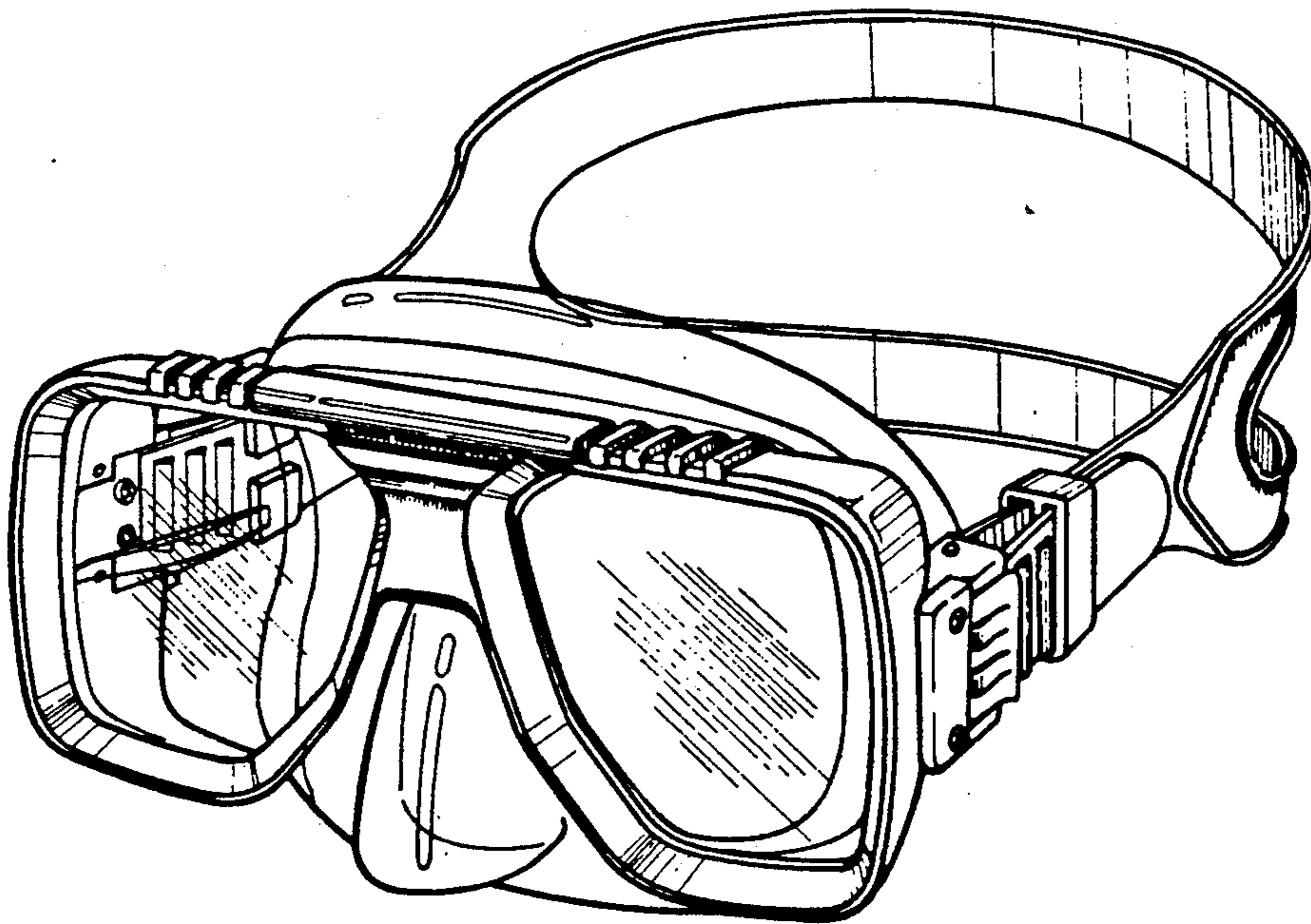

FIG.1

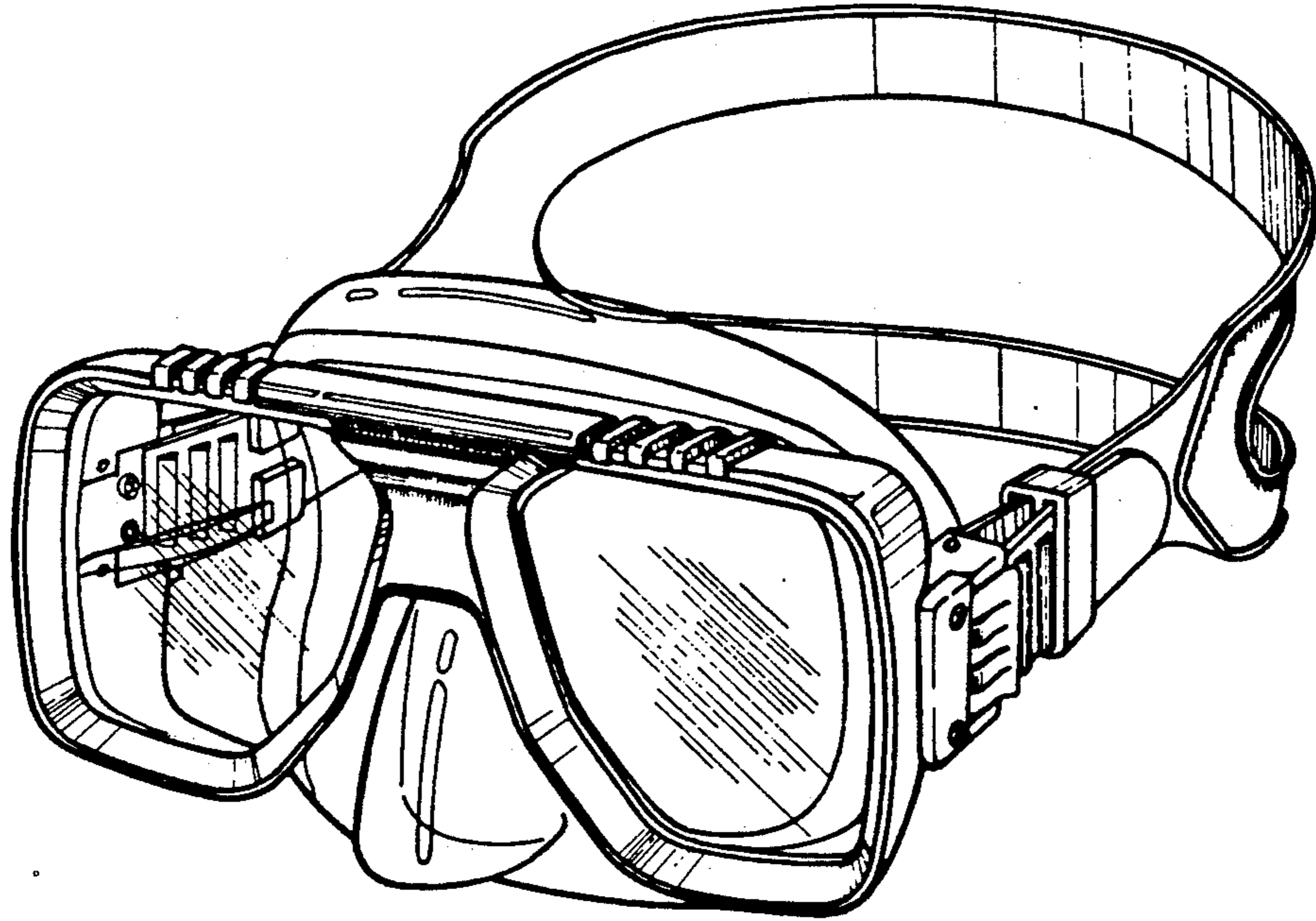

FIG.2

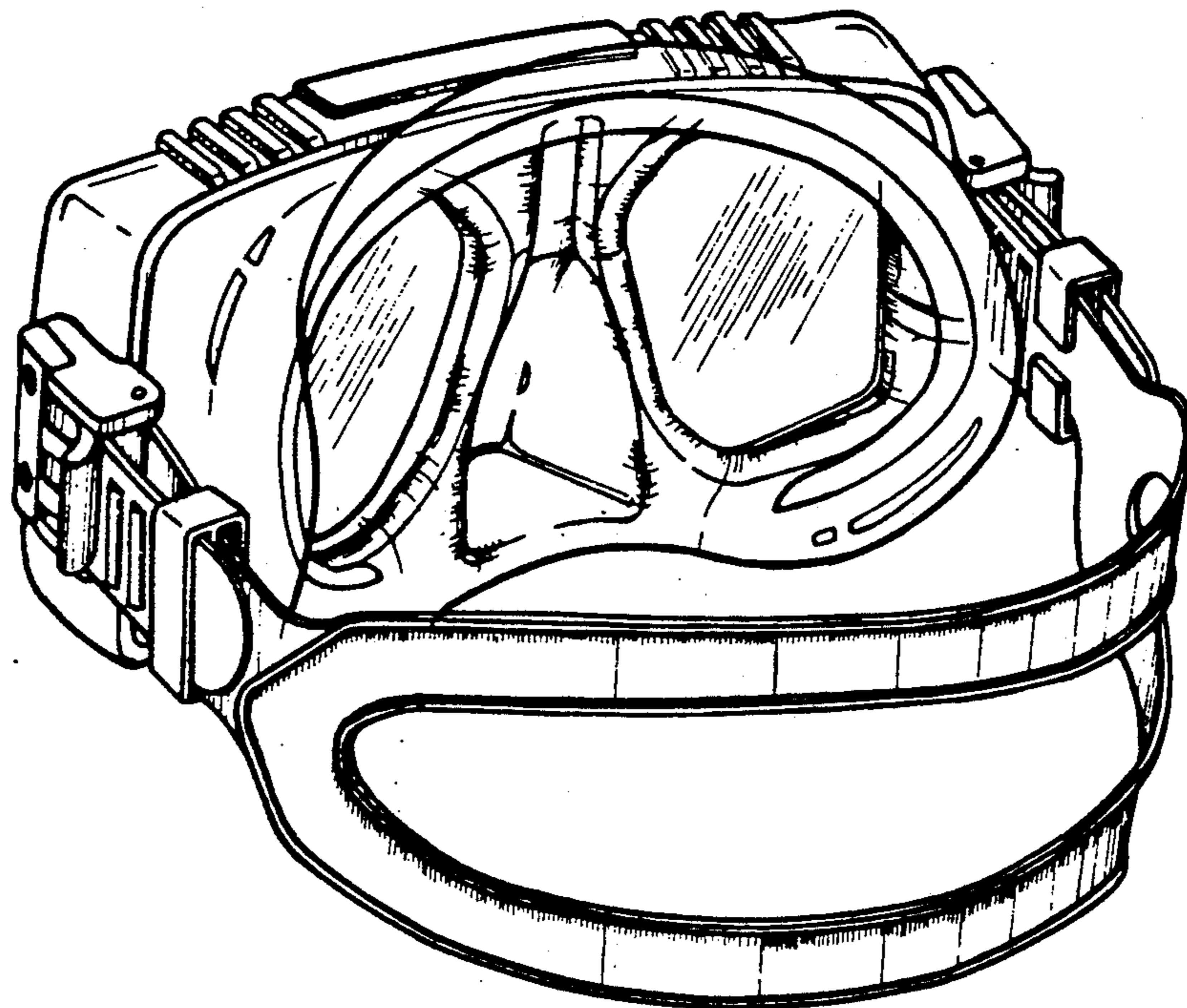

FIG.3

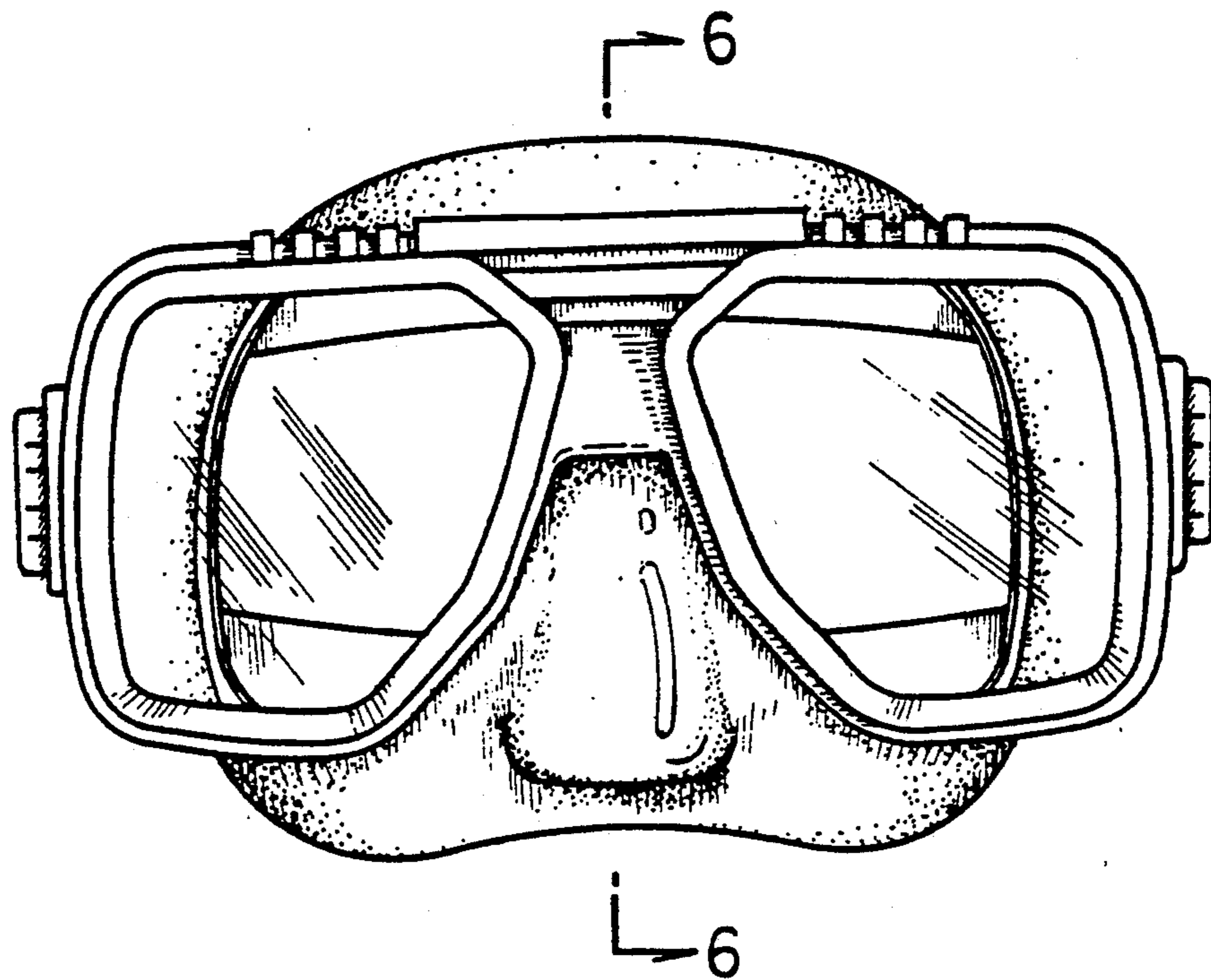

FIG.4

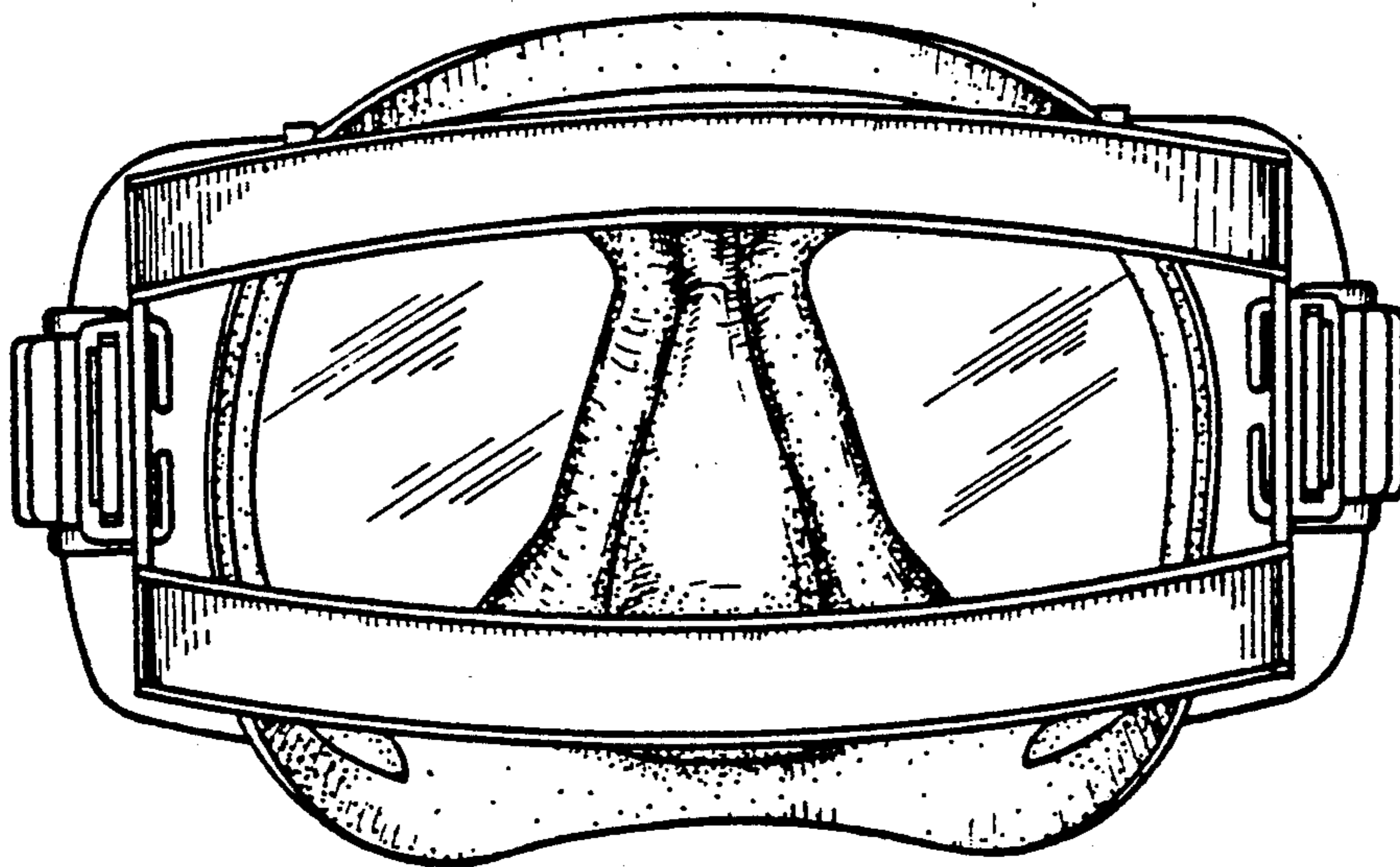

FIG.5

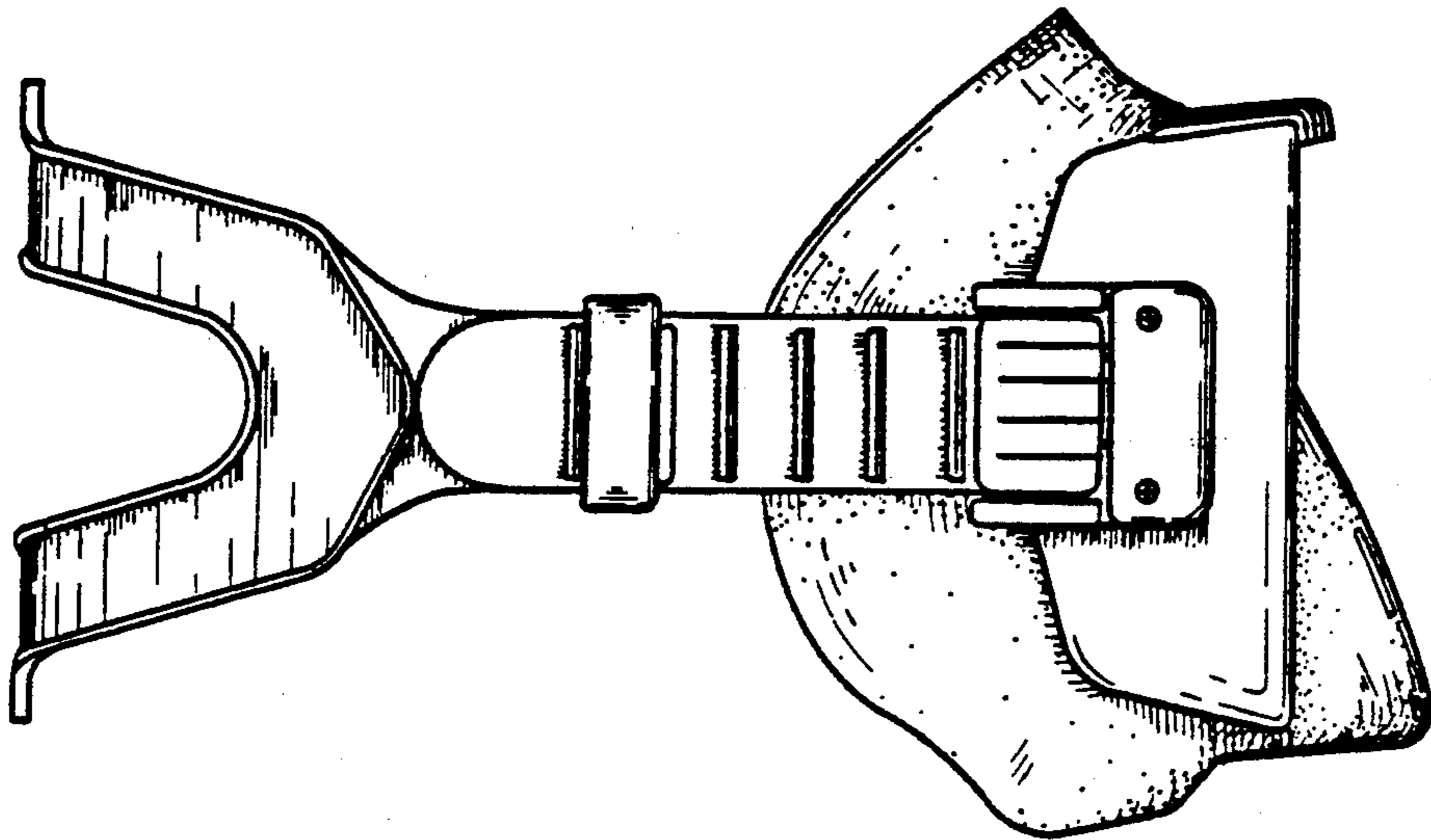

FIG.6

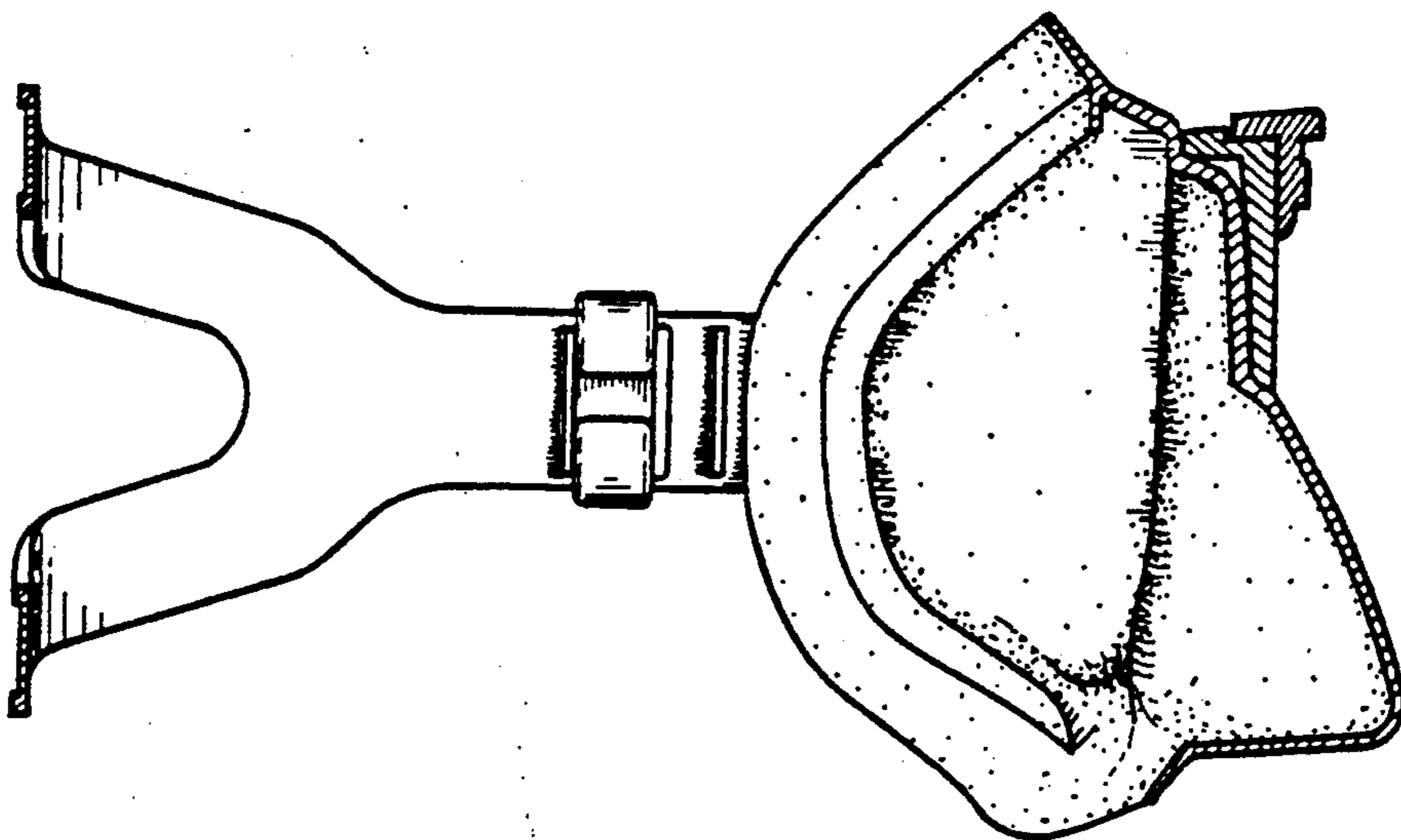

FIG.7

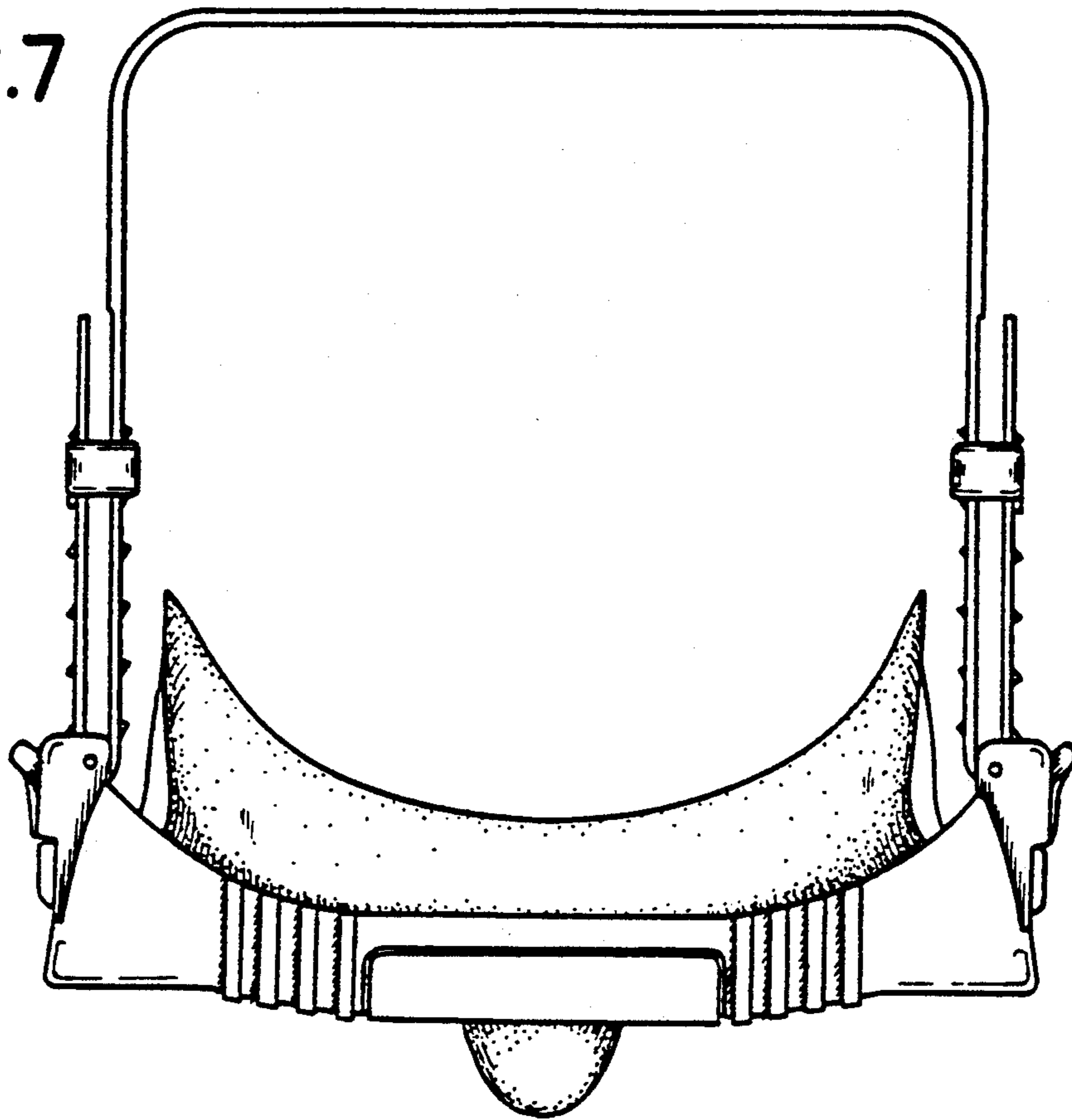

FIG.8

