

[54] TRAY FOR MEMORY MODULE OR THE LIKE

4,040,518 8/1977 Carter ..... 206/564 X  
4,117,931 10/1978 Berkman ..... 206/561 X  
4,735,318 4/1988 Keffeler ..... 206/561 X

[75] Inventor: Adrian J. Amelse, Santa Clara, Calif.

[73] Assignee: Apple Computer, Inc., Cupertino, Calif.

[\*\*] Term: 14 Years

[21] Appl. No.: 297,263

[22] Filed: Jan. 13, 1989

[52] U.S. Cl. .... D9/341; D34/46; D9/425

[58] Field of Search ..... D9/341, 347, 424, 425, D9/431; D34/45, 46, 40; 206/564, 561, 518, 309, 387; 220/555, 553, 608, 549

[56] References Cited

U.S. PATENT DOCUMENTS

- D. 218,629 9/1970 Hasselbach ..... D9/425 X
- D. 252,115 6/1979 Herring ..... D9/341 X
- D. 274,967 8/1984 Taylor ..... D34/40 X
- D. 292,138 9/1987 Gatlin, Jr. .... D34/45
- 3,976,193 8/1976 Dogliotti ..... 206/561 X

OTHER PUBLICATIONS

Thermalene cat. May 1980, p. 6, item A, top right of the page.

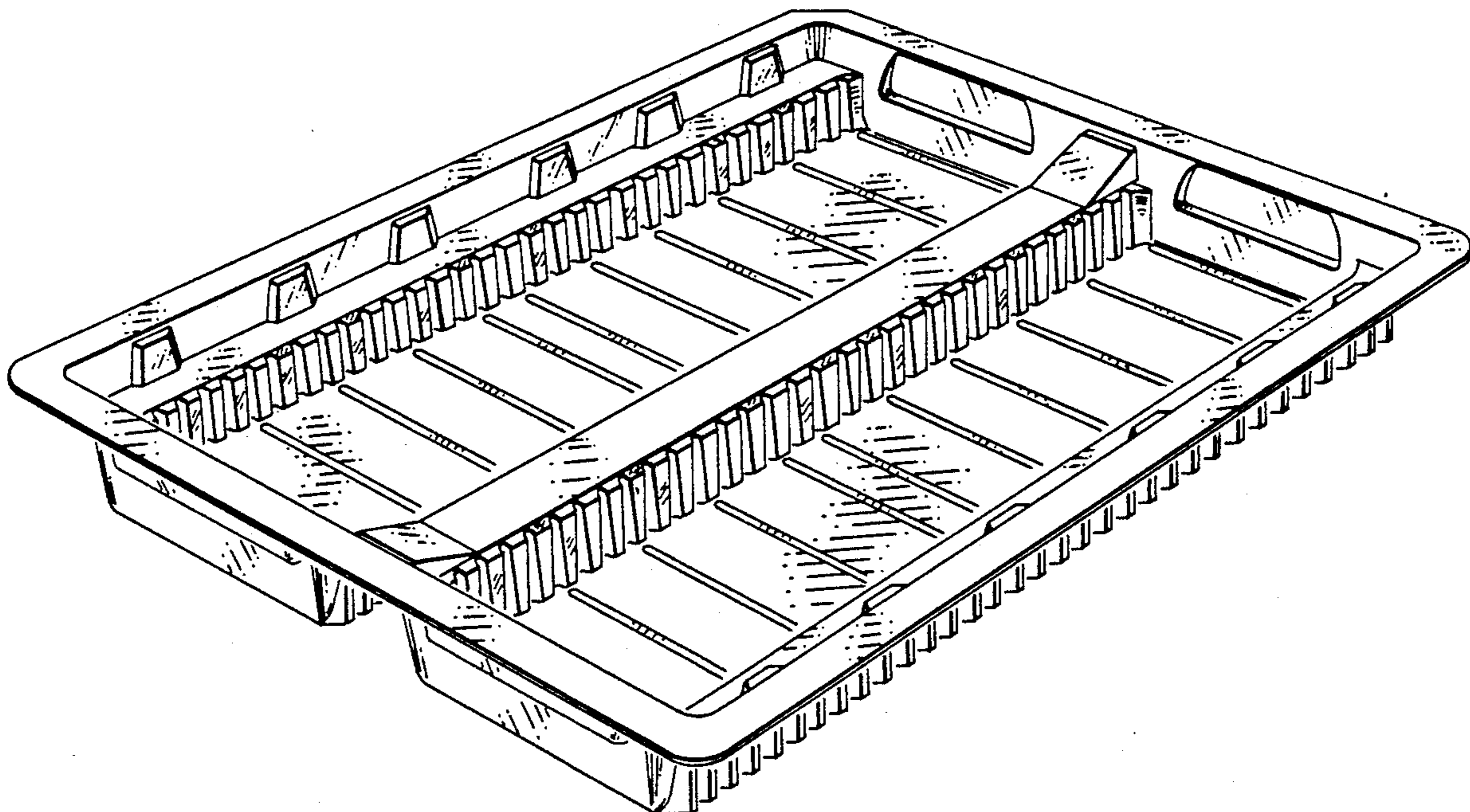
Primary Examiner—Bernard Ansher  
Assistant Examiner—Prabhakar Deshmukh  
Attorney, Agent, or Firm—Franklyn C. Weiss

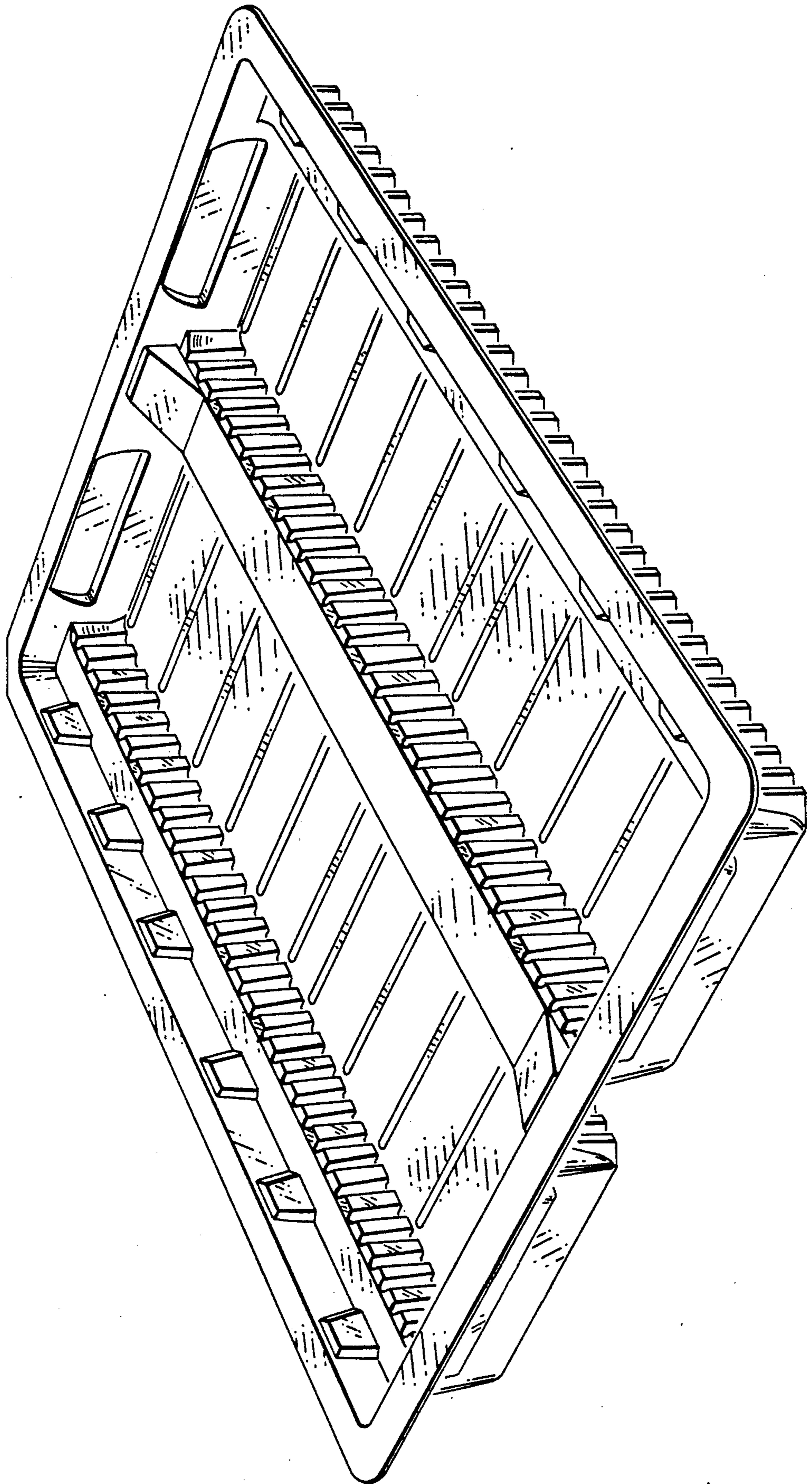
[57] CLAIM

The ornamental design for a tray for memory module or the like, as shown and described.

DESCRIPTION

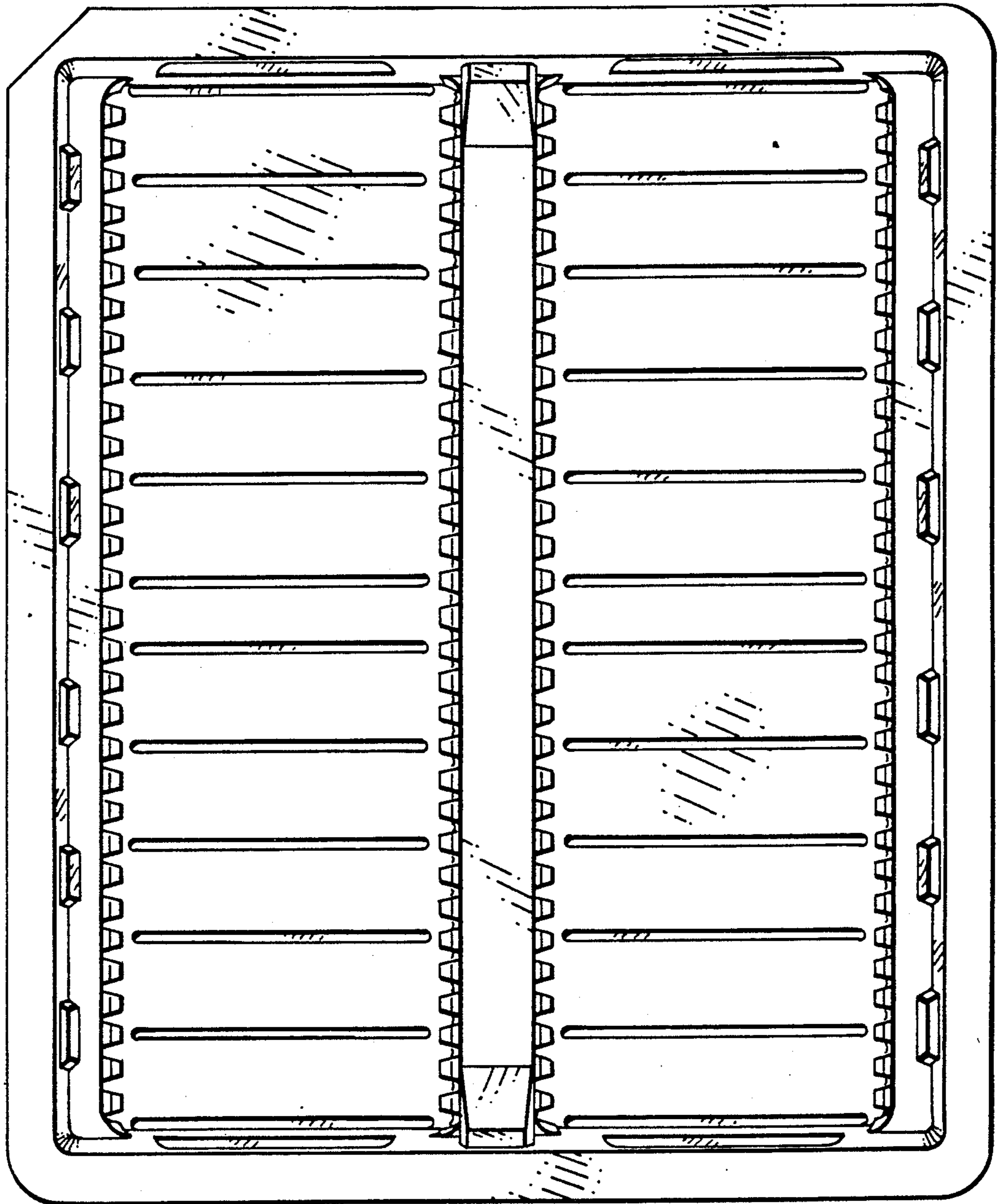
FIG. 1 is a perspective view of a tray for memory module or the like showing our new design; FIG. 2 is a top plan view thereof; FIG. 3 is a front elevation thereof; FIG. 4 is a bottom plan view thereof; FIG. 5 is a rear elevation thereof; FIG. 6 is a left side elevation thereof; and FIG. 7 is a right side elevation thereof.



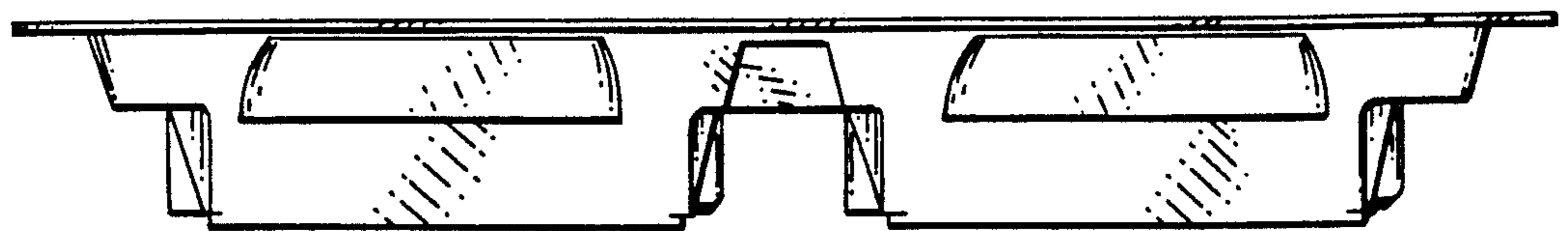


**FIG. 1**

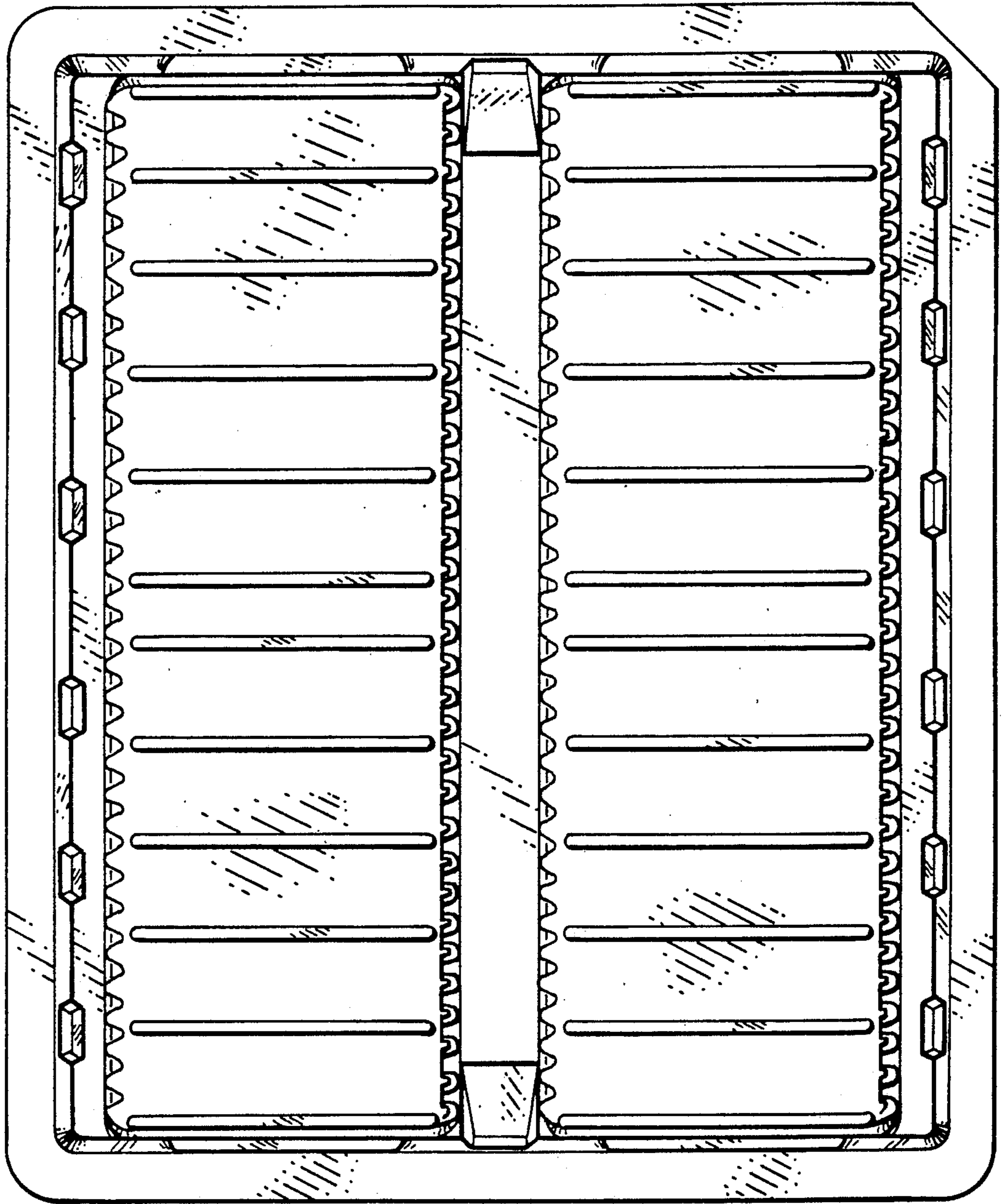
**FIG. 2**



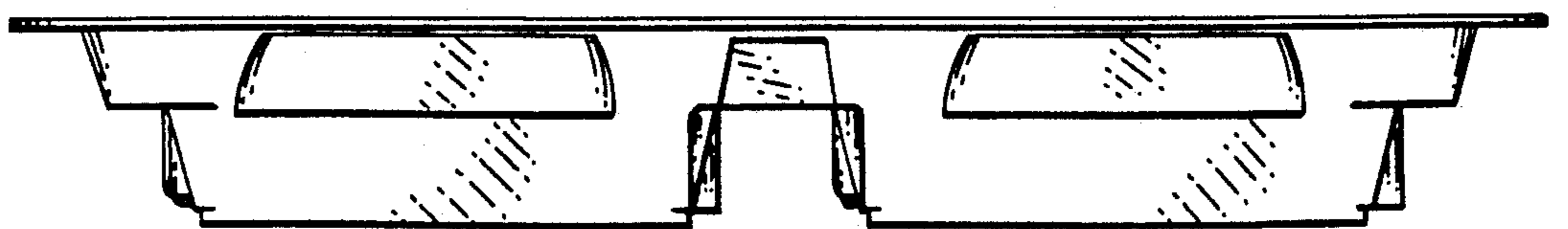
**FIG. 3**



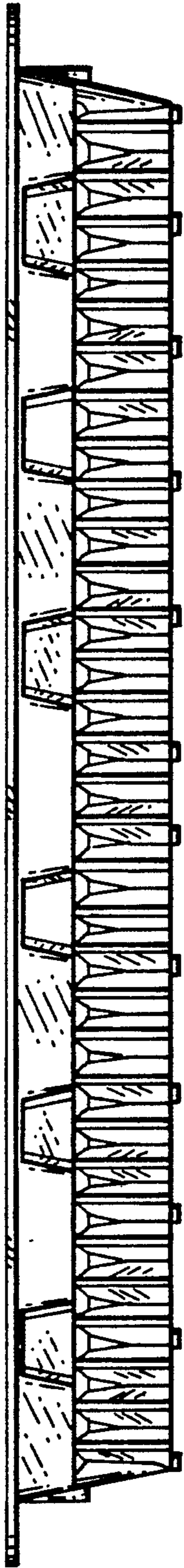
**FIG 4**



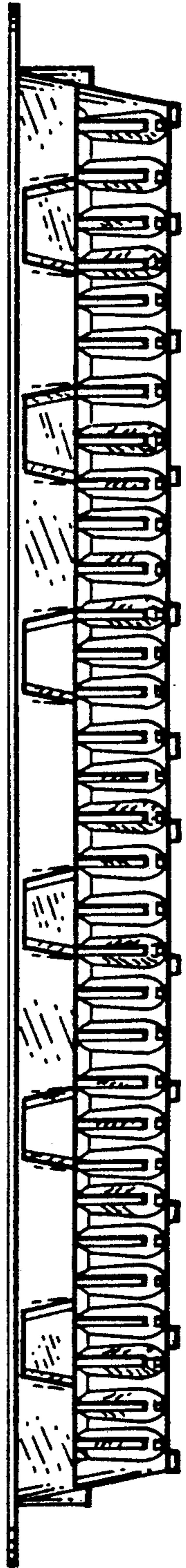
**FIG 5**



**FIG. 6**



**FIG. 7**



UNITED STATES PATENT AND TRADEMARK OFFICE  
**CERTIFICATE OF CORRECTION**

PATENT NO. : Des. 318,420  
DATED : July 23, 1991  
INVENTOR(S) : Adrian J. Amelse

It is certified that error appears in the above-identified patent and that said Letters Patent  
is hereby corrected as shown below:  
On Title page item [54]

Change the "Inventor" to:

Adrian J. Amelse, Santa Clara, California

Korte Lee, Piedmont, California

**Signed and Sealed this**  
**Twenty-second Day of December, 1992**

*Attest:*

DOUGLAS B. COMER

*Attesting Officer*

*Acting Commissioner of Patents and Trademarks*