

[54] WALL-MOUNTED CONTAINER WITH ASH TRAY

D. 296,142 6/1988 Adamson D34/7
4,577,778 3/1986 Kim 220/908

[75] Inventor: Paul E. Delmerico, Winchester, Va.

Primary Examiner—Kay H. Chin
Attorney, Agent, or Firm—Richard B. O'Planick

[73] Assignee: Rubbermaid Commercial Products Inc., Wichester, Va.

[57] CLAIM

[**] Term: 14 Years

The ornamental design for a wall-mounted container with ash tray, as shown and described.

[21] Appl. No.: 317,691

DESCRIPTION

[22] Filed: Feb. 28, 1989

[52] U.S. Cl. D34/7; D34/8

[58] Field of Search D34/1, 7, 8, 9, 11;
220/18, 908, 909, 910, 94 R; 232/1 R; D27/105,
102, 125

FIG. 1 is a top front perspective view of a wall-mounted container with ash tray showing my new design.

FIG. 2 is a front elevational view thereof.

FIG. 3 is a rear elevational view thereof.

FIG. 4 is a top plan view thereof.

FIG. 5 is a bottom plan view thereof.

FIG. 6 is a side elevational view thereof; the opposite side being a mirror image.

FIG. 7 is a transverse sectional view thereof taken along the line 7—7 of FIG. 4.

[56] References Cited

U.S. PATENT DOCUMENTS

D. 256,089 7/1980 Adamson D34/8
D. 280,459 9/1985 McClelland D34/8

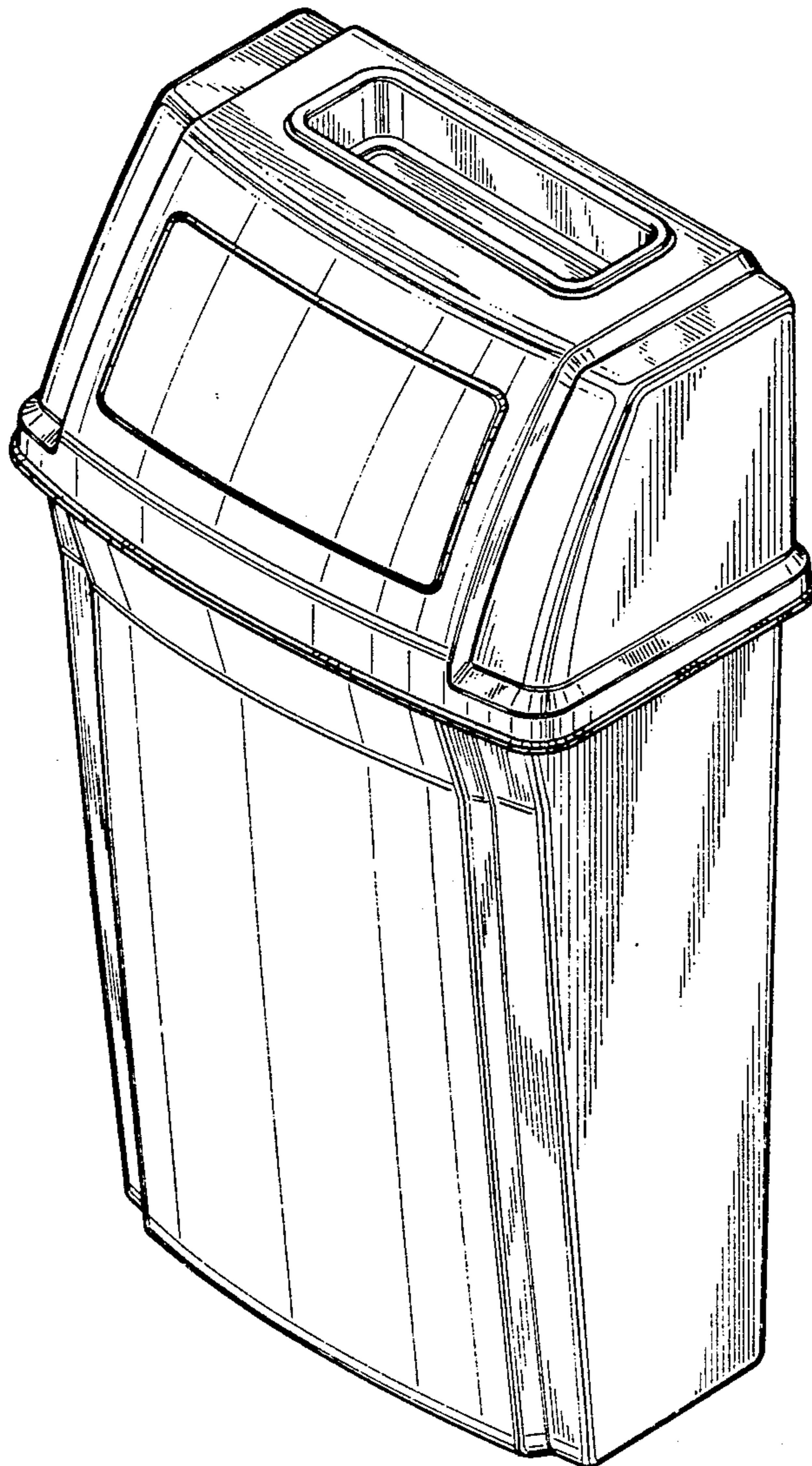

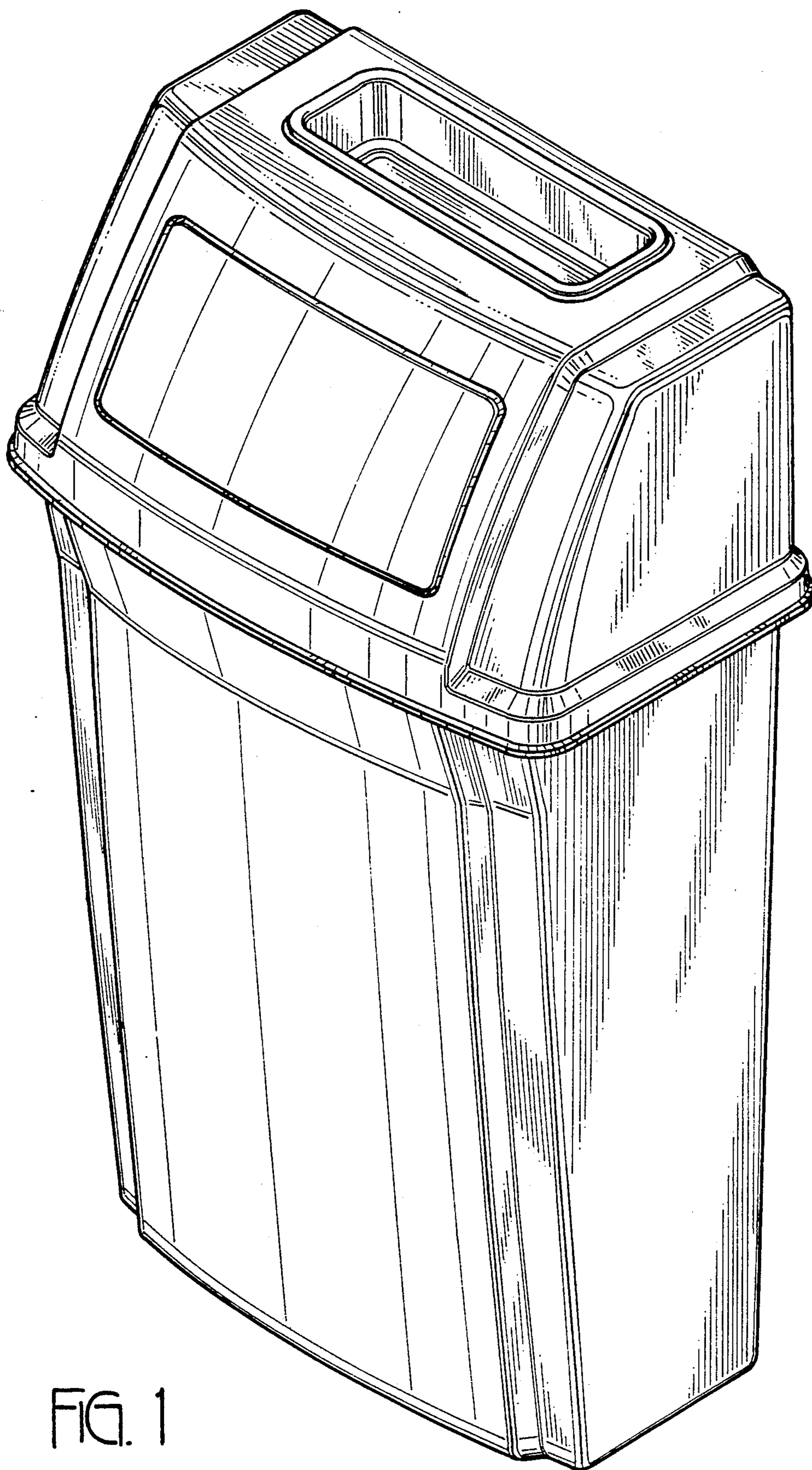

FIG. 1

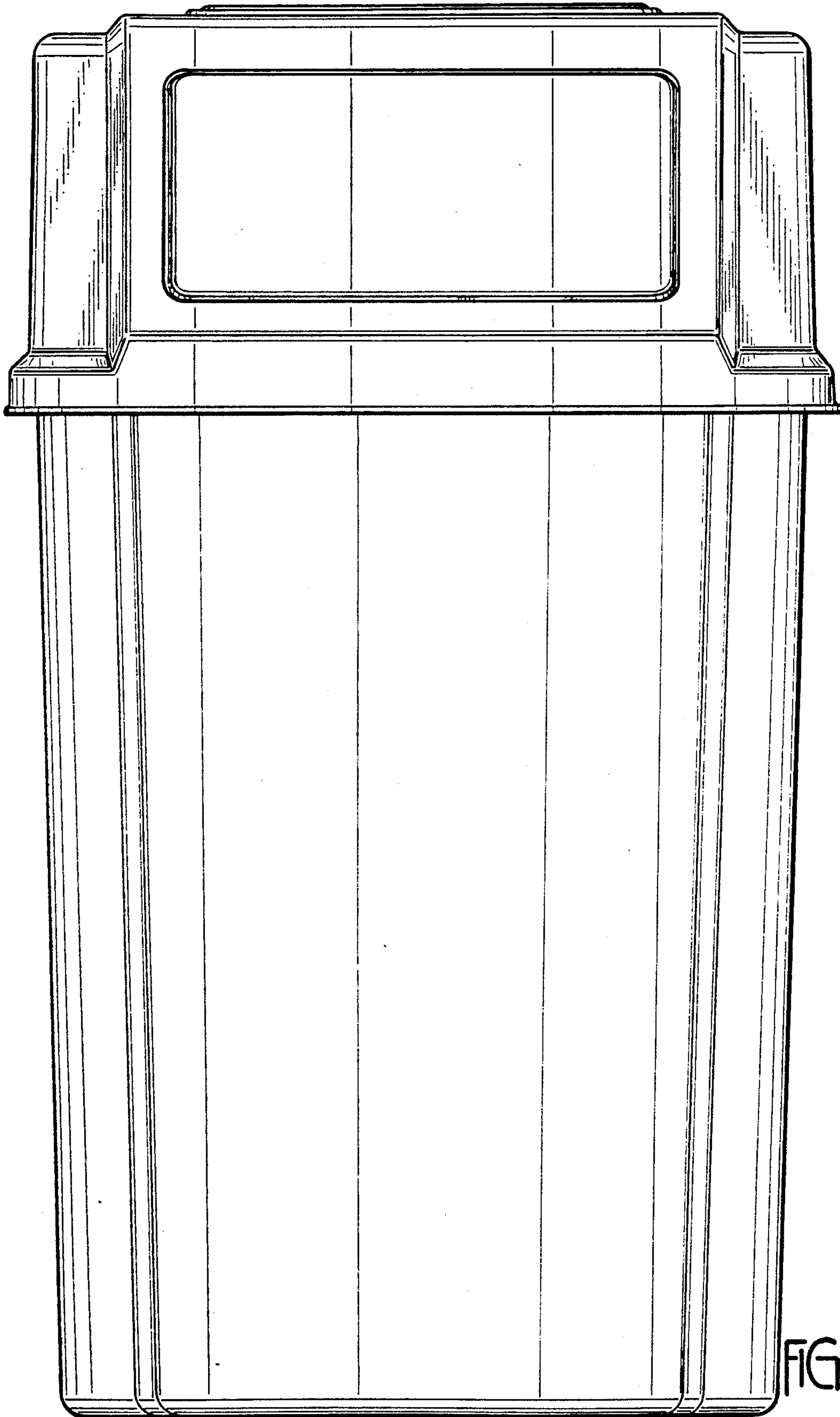

FIG. 2

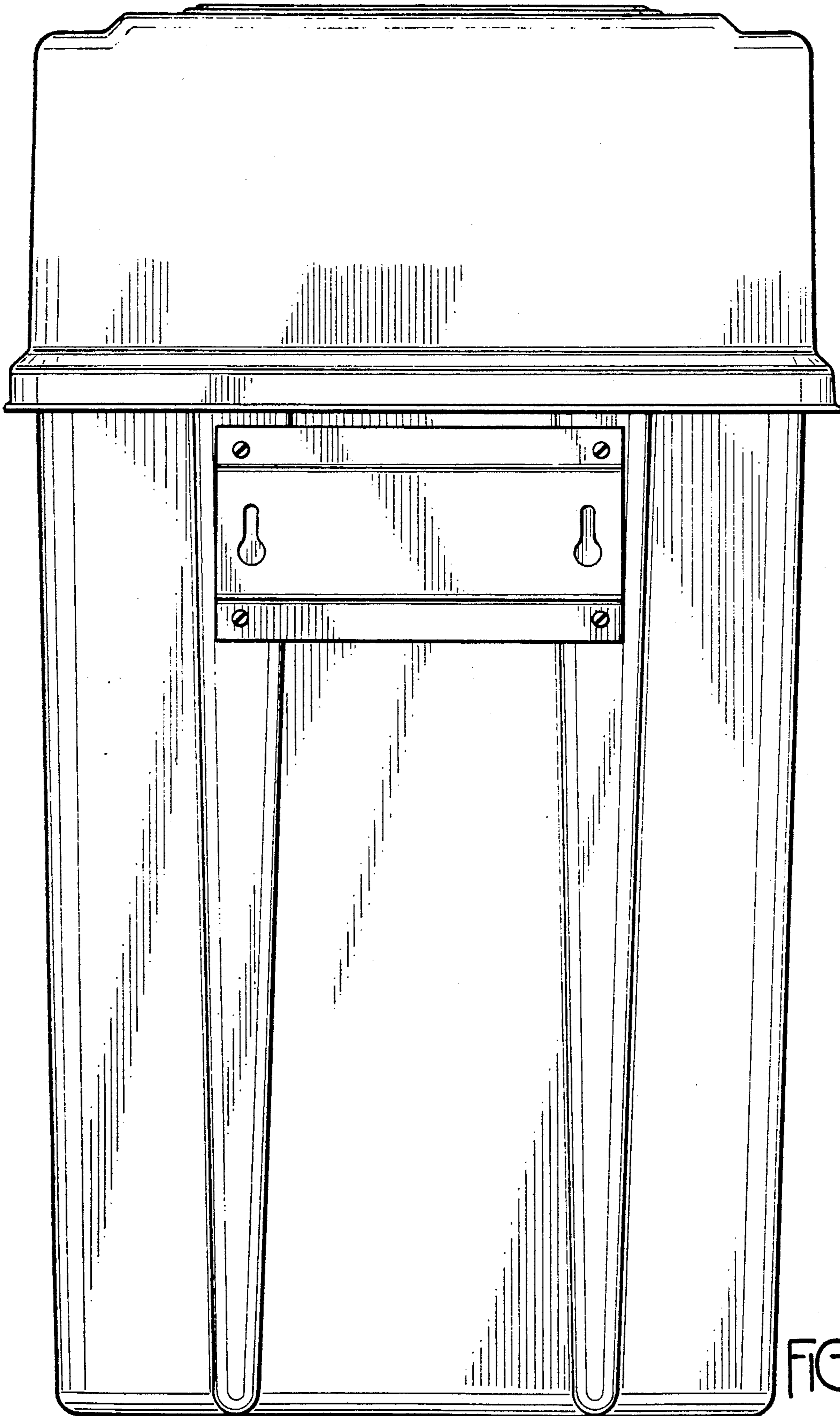
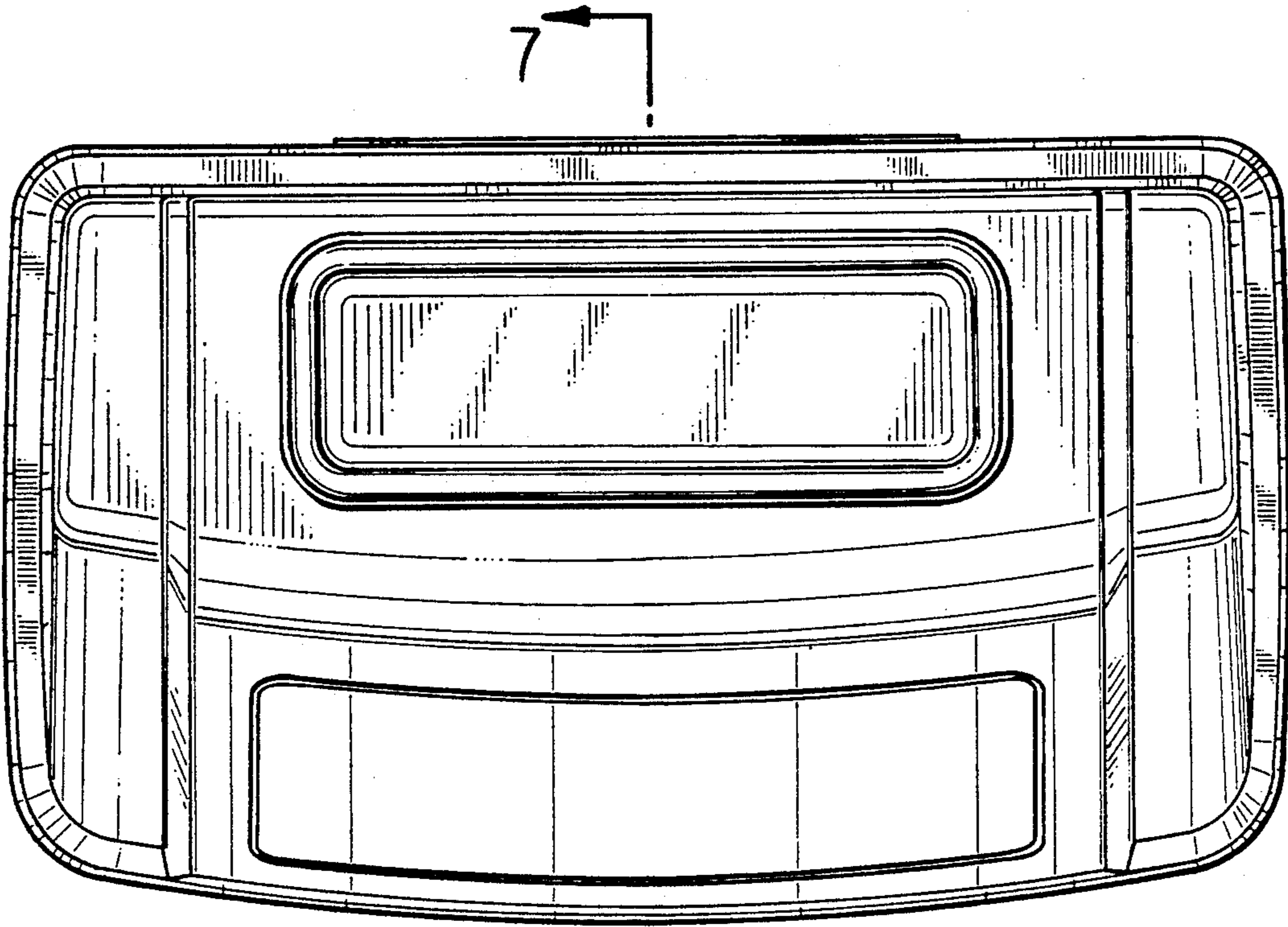

FIG. 3



7-7 FIG. 4

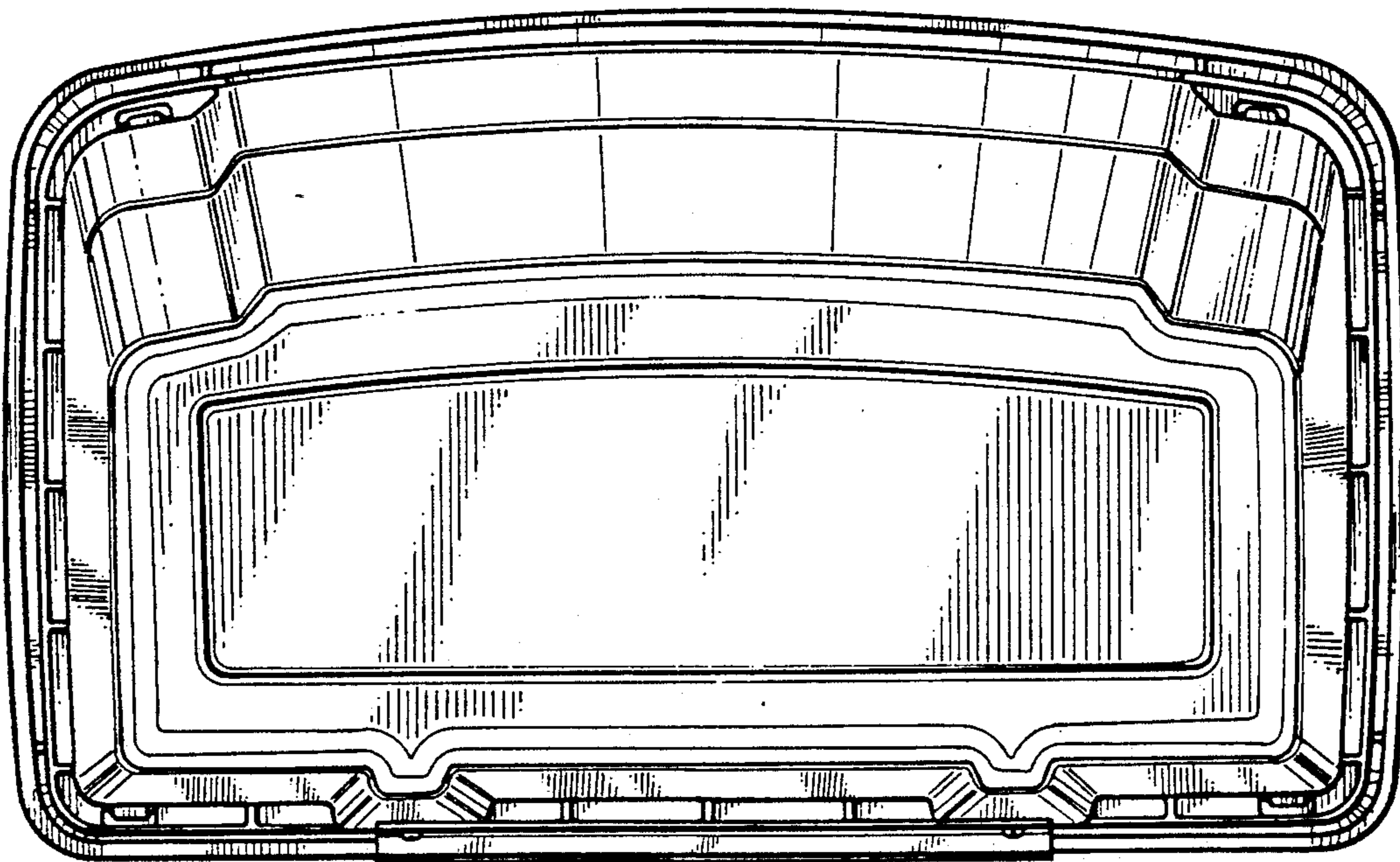

FIG. 5

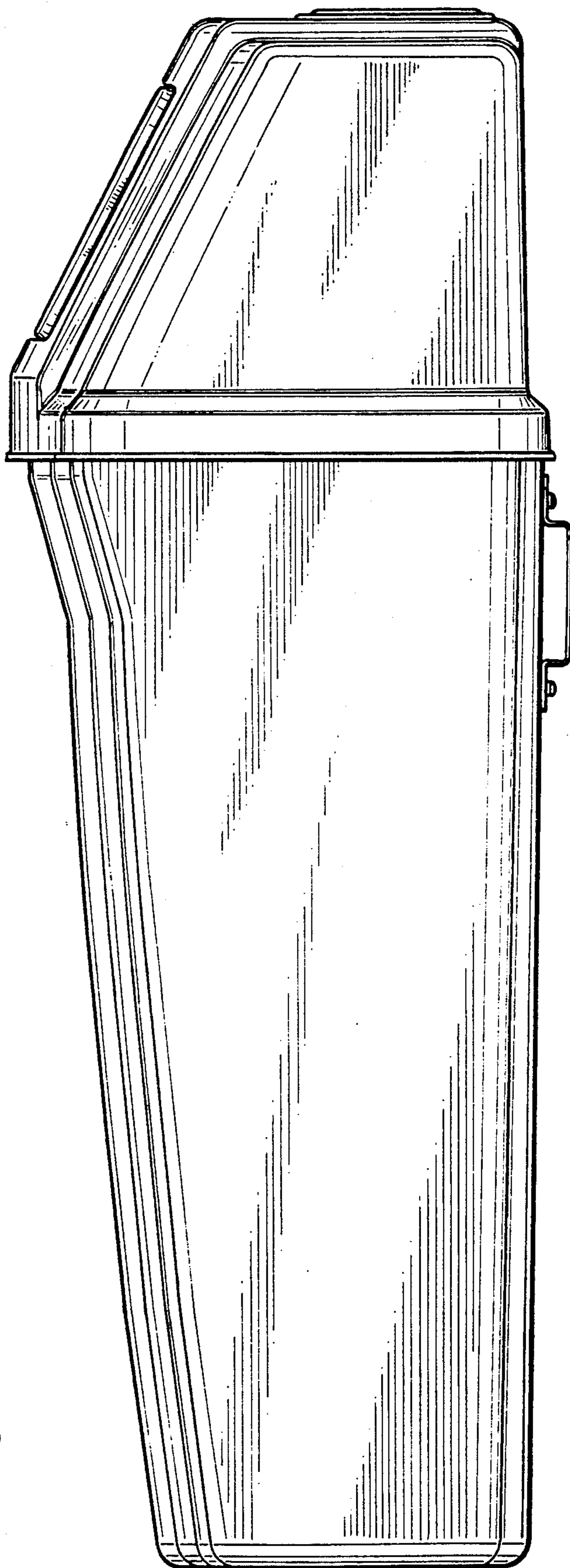

FIG. 6

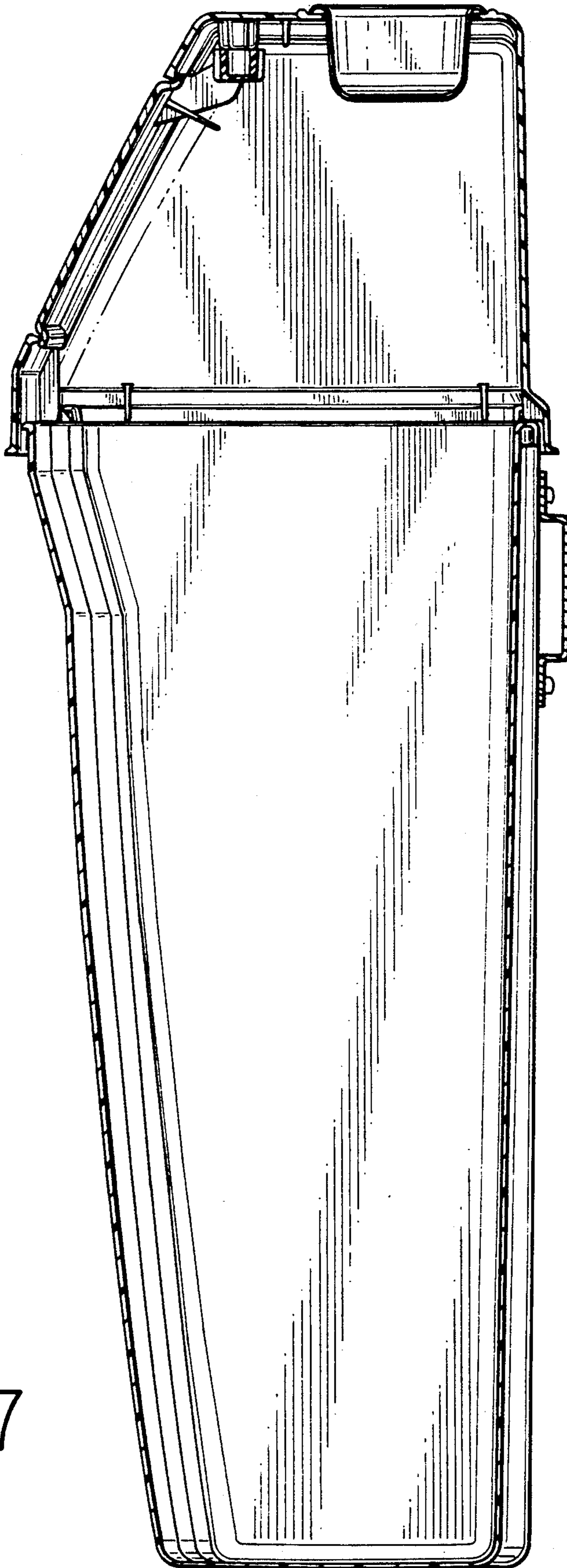

FIG. 7