

[54] RECUMBENT BICYCLE

[76] Inventor: Alfred D. Turowski, 105 Cedar St., East Bridgewater, Mass. 02333

[**] Term: 14 Years

[21] Appl. No.: 431,631

[22] Filed: Nov. 3, 1989

[52] U.S. Cl. D12/111

[58] Field of Search D12/111; 280/281.1, 280/288.1, 288.2, 288.3

[56] References Cited

U.S. PATENT DOCUMENTS

D. 236,803	9/1975	Ennis	D12/111
D. 248,634	7/1978	Souza et al.	D12/111
D. 275,273	8/1984	Martin et al.	D12/111
D. 293,660	1/1988	Foehner	D12/111
D. 299,220	1/1989	Trusky	D12/111
3,595,599	7/1971	Black	D12/111

FOREIGN PATENT DOCUMENTS

3020937	12/1981	Fed. Rep. of Germany	...	280/288.1
3516320	11/1986	Fed. Rep. of Germany	...	280/288.1
0195208	4/1938	Switzerland	280/288.1

OTHER PUBLICATIONS

American Bicyclist & Motorcyclist, Jun. 1987, p. 28, Recumbent Biccyle(A).

Primary Examiner—James M. Gandy
Assistant Examiner—Melody Brown

[57] CLAIM

The ornamental design for a recumbent bicycle, as shown.

DESCRIPTION

FIG. 1 is a front elevation view of a recumbent bicycle showing the new design;
FIG. 2 is a left-side elevation view thereof;
FIG. 3 is a right-side elevation view thereof;
FIG. 4 is a rear elevation view thereof;
FIG. 5 is a top plan view thereof;
FIG. 6 is a bottom plan view thereof;

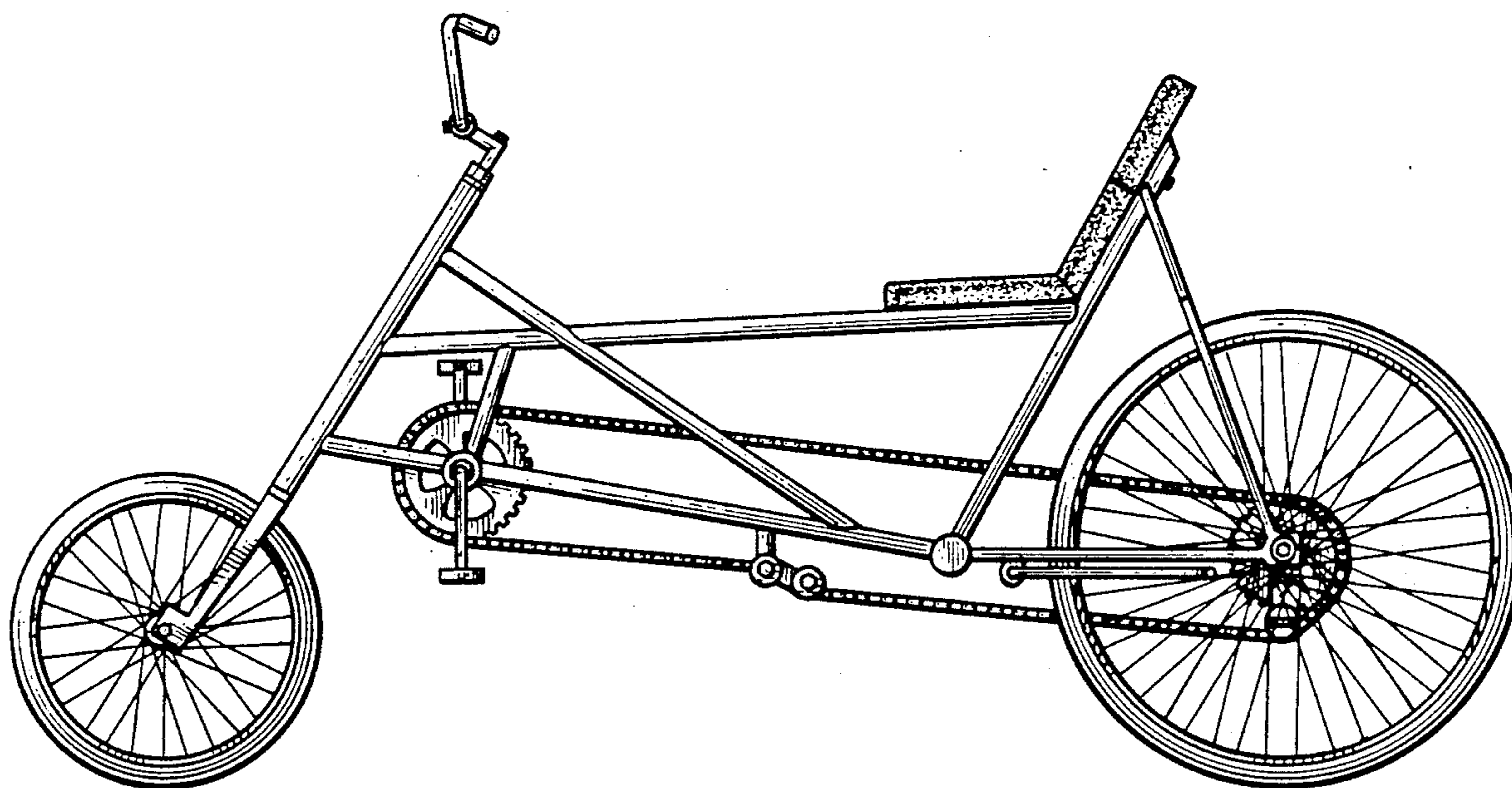

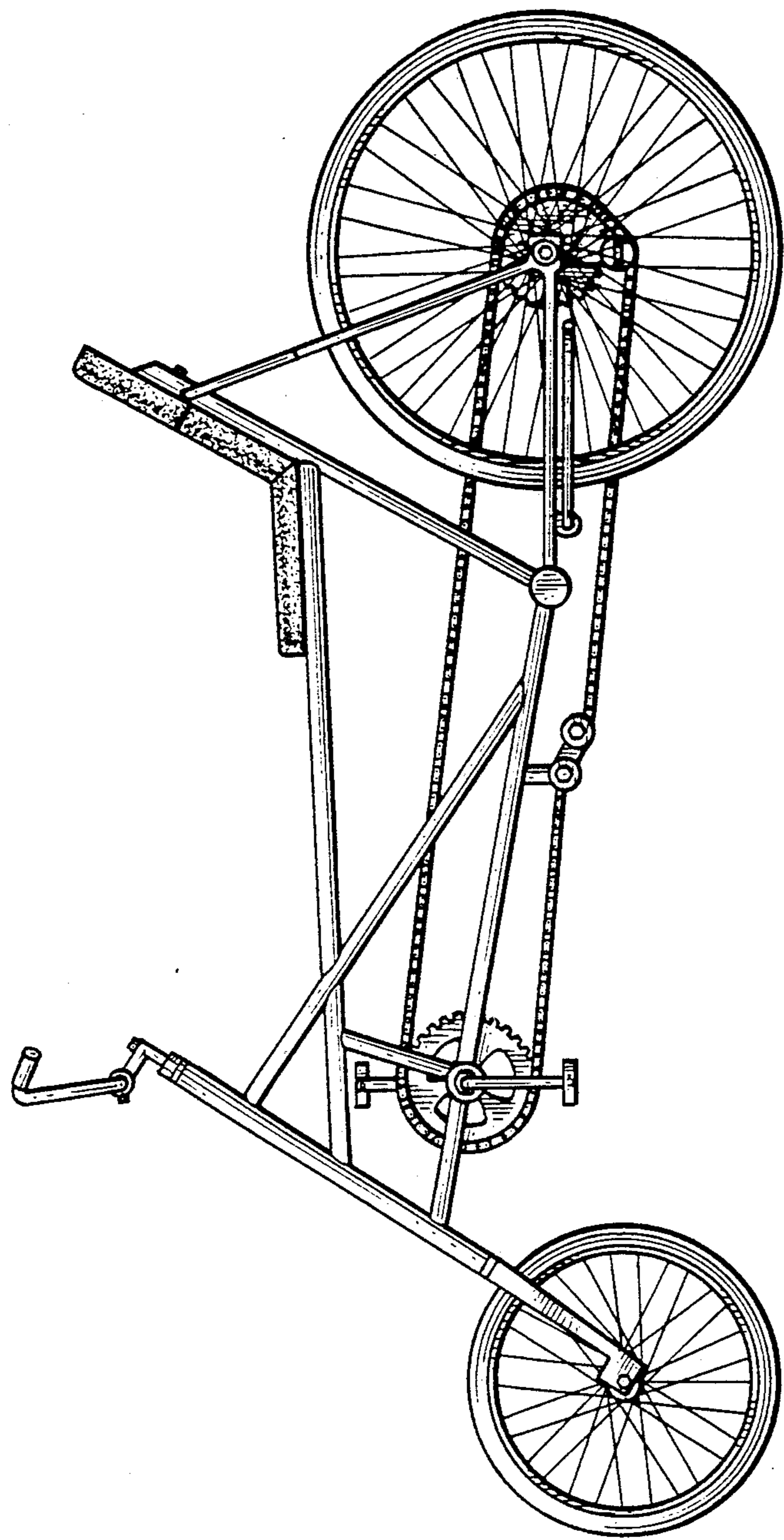

Fig. 1.

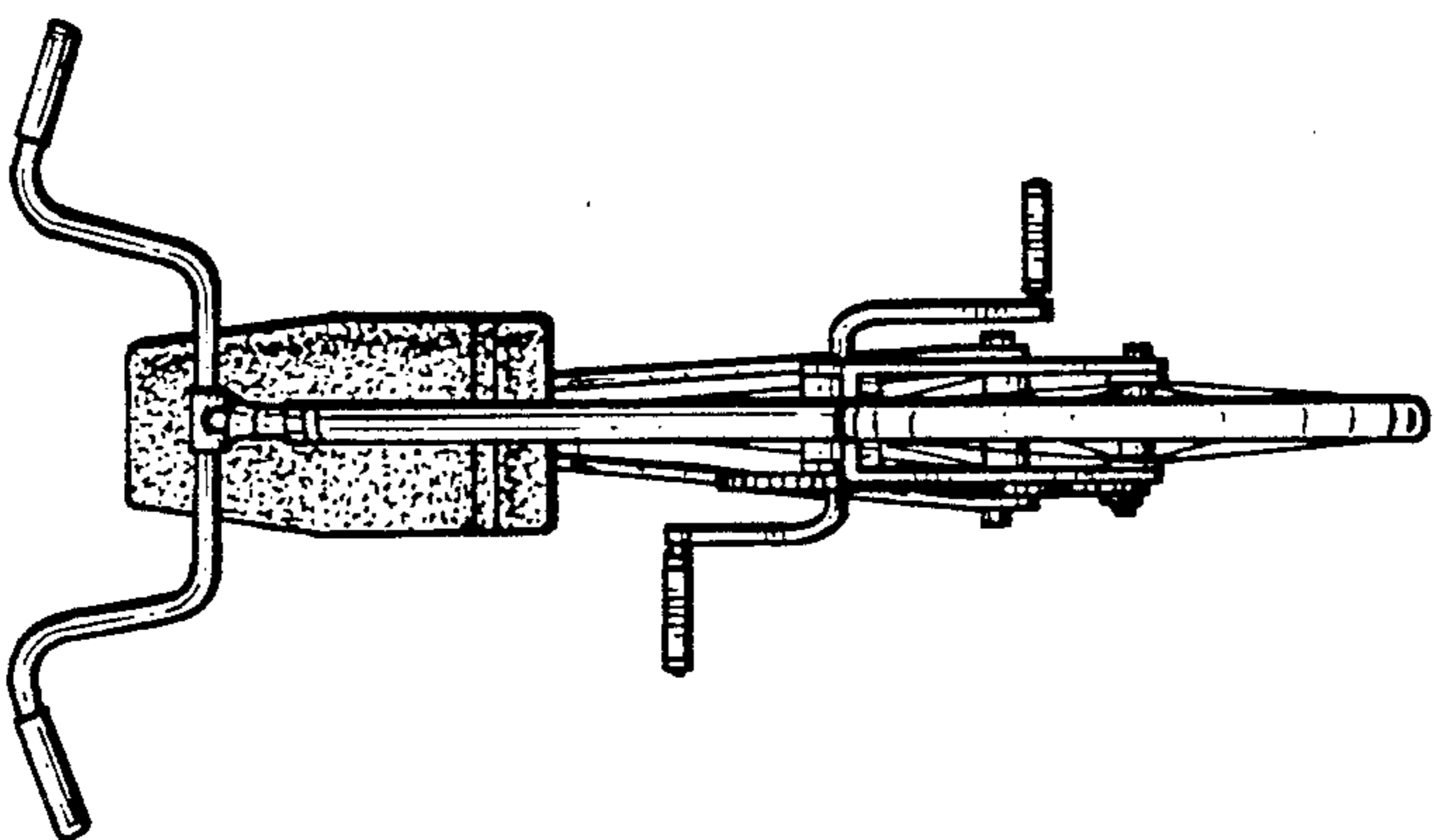

Fig. 2.

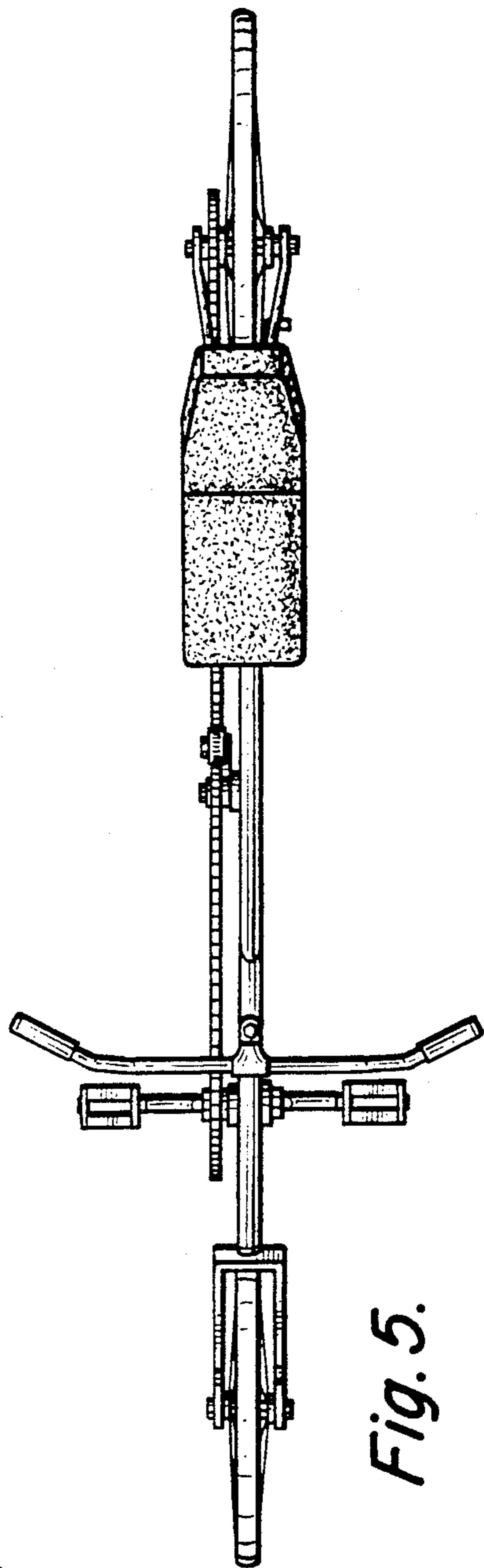

Fig. 5.

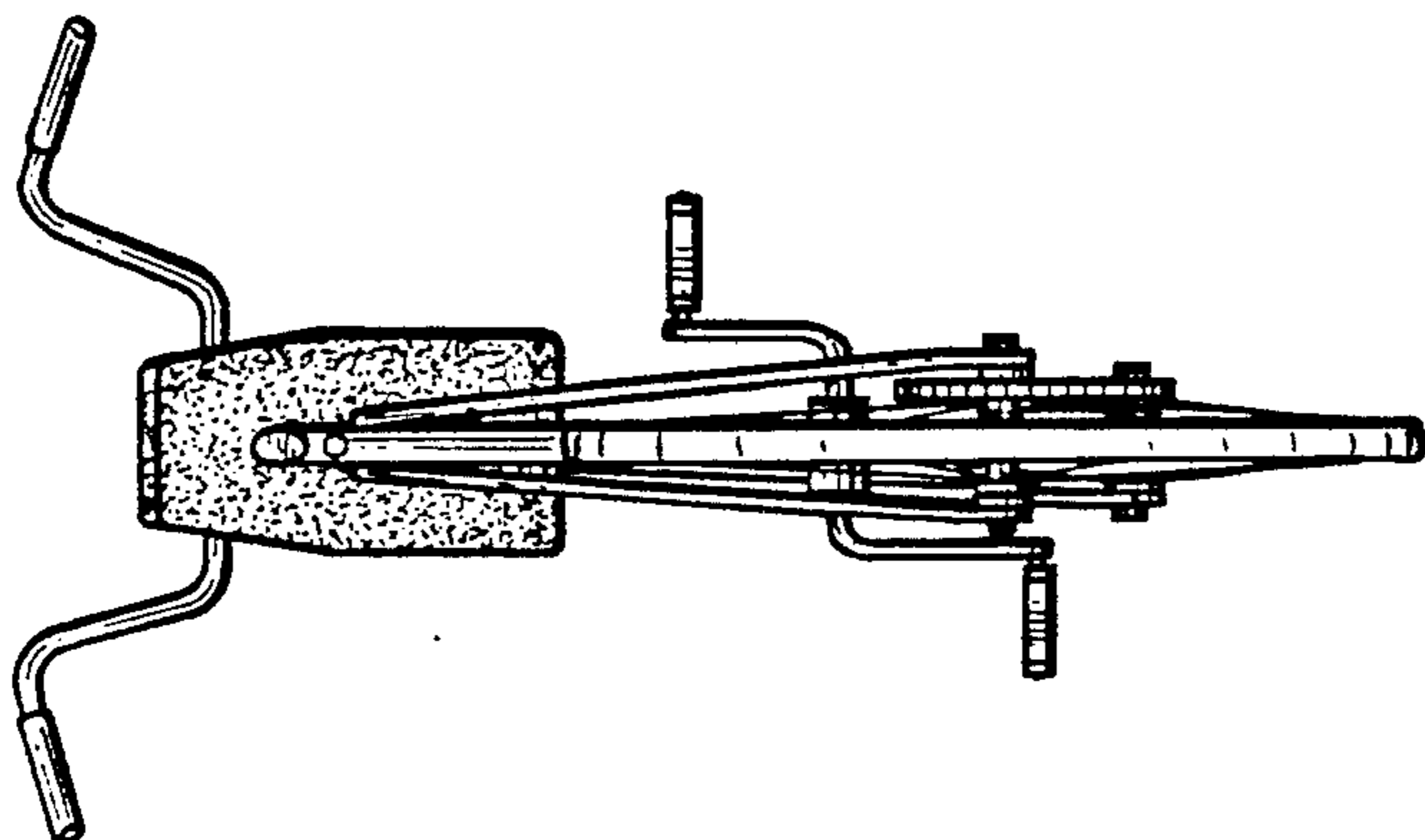

Fig. 4.

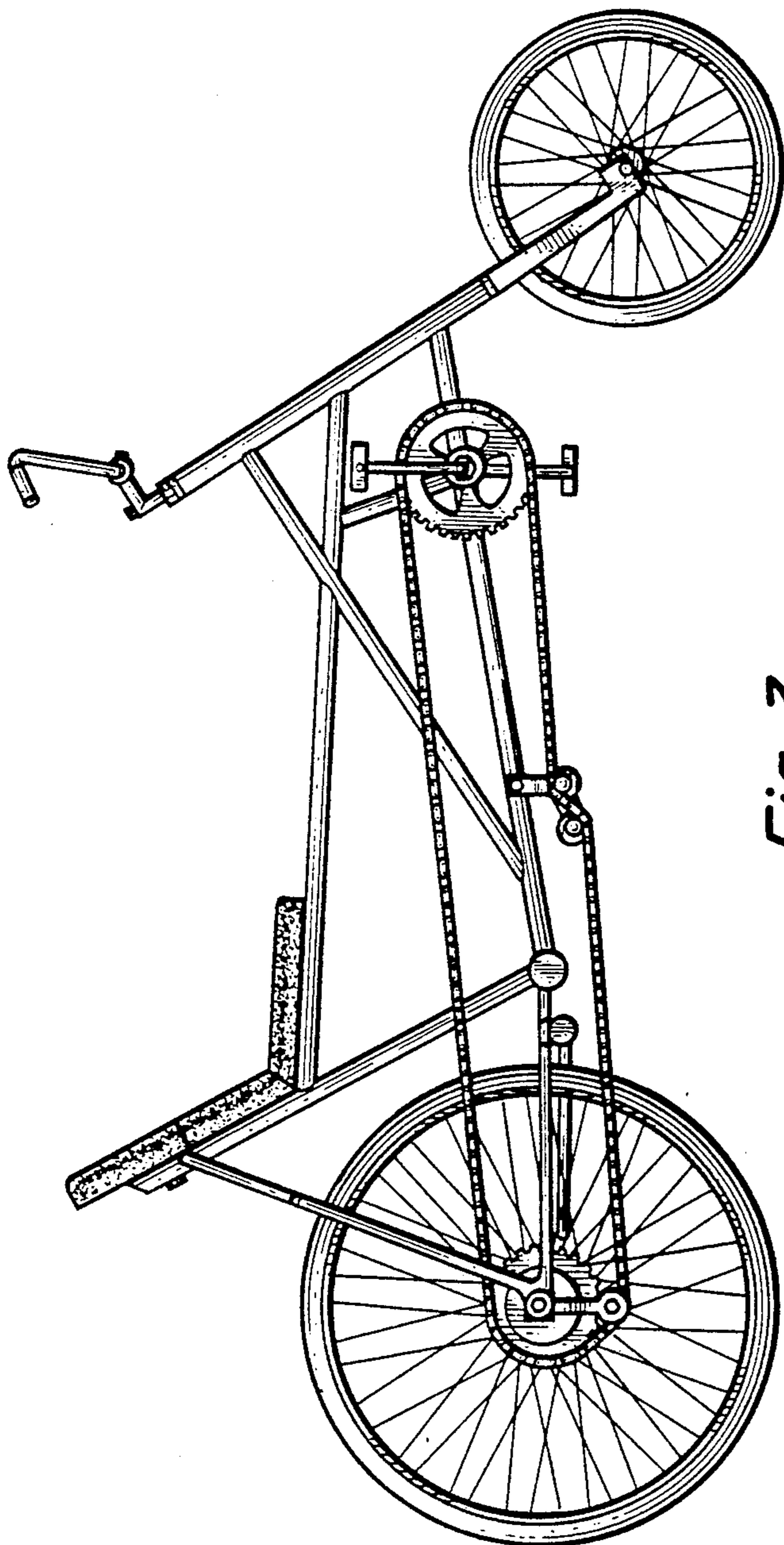

Fig. 3.

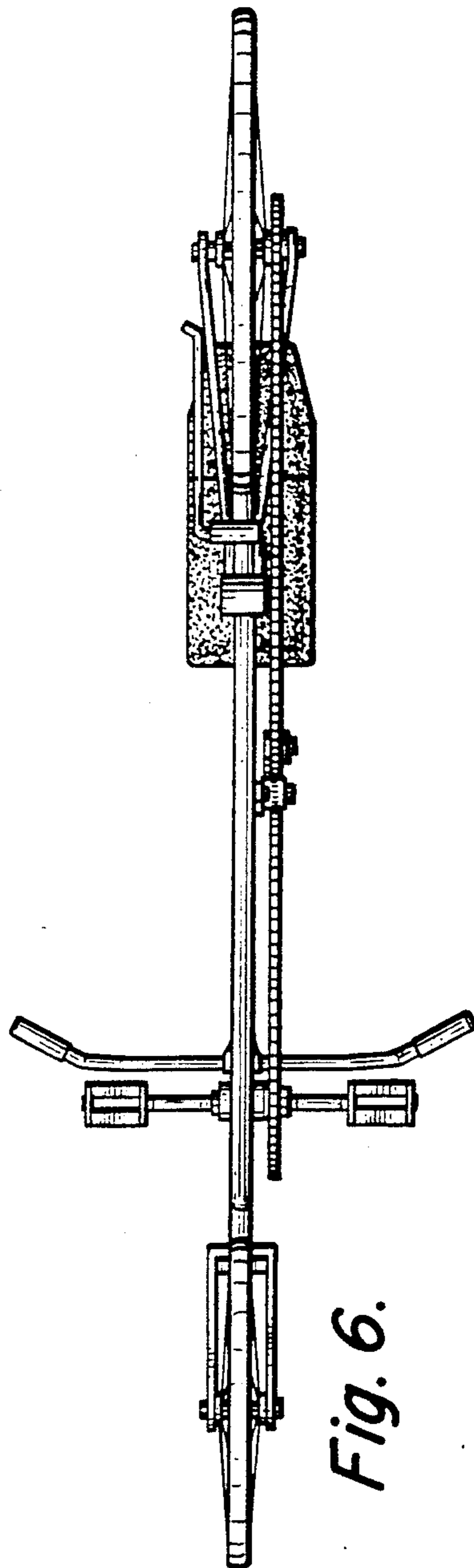

Fig. 6.