

United States Patent [19]
Saito

[11] **Patent Number: Des. 318,063**

[45] **Date of Patent: ** Jul. 9, 1991**

[54] **CASH REGISTER**

[75] **Inventor: Kiyoshi Saito, Tokyo, Japan**

[73] **Assignee: Tokyo Electric Co., Ltd., Tokyo, Japan**

[**] **Term: 14 Years**

[21] **Appl. No.: 447,024**

[22] **Filed: Dec. 7, 1989**

[30] **Foreign Application Priority Data**

Jul. 5, 1989 [JP] Japan 1-24609

[52] **U.S. Cl. D18/4**

[58] **Field of Search D18/3, 4; D14/100, 105, D14/106, 113; 235/1 D, 1 E, 2, 4, 7 R, 10, 375, 379, 380, 419; 364/404, 405**

[56] **References Cited**

U.S. PATENT DOCUMENTS

D. 234,314	2/1975	Knapp et al.	D18/4
D. 235,802	7/1975	Stoltz et al.	D18/4
D. 240,048	5/1976	Greene et al.	D18/4
D. 247,588	3/1978	Stoltz et al.	D18/4
D. 310,212	8/1990	Forsythe	D18/4 X

Primary Examiner—Nelson C. Holtje
Assistant Examiner—Caron D. Veynar
Attorney, Agent, or Firm—Bacon & Thomas

[57] **CLAIM**

The ornamental design for a cash register, as shown.

DESCRIPTION

FIG. 1 is a top, front and right side perspective view of a cash register showing my new design;
FIG. 2 is a front elevational view thereof;
FIG. 3 is a rear elevational view thereof;
FIG. 4 is a top plan view thereof;
FIG. 5 is a bottom plan view thereof;
FIG. 6 is a right side elevational view thereof; and
FIG. 7 is a left side elevational view thereof.

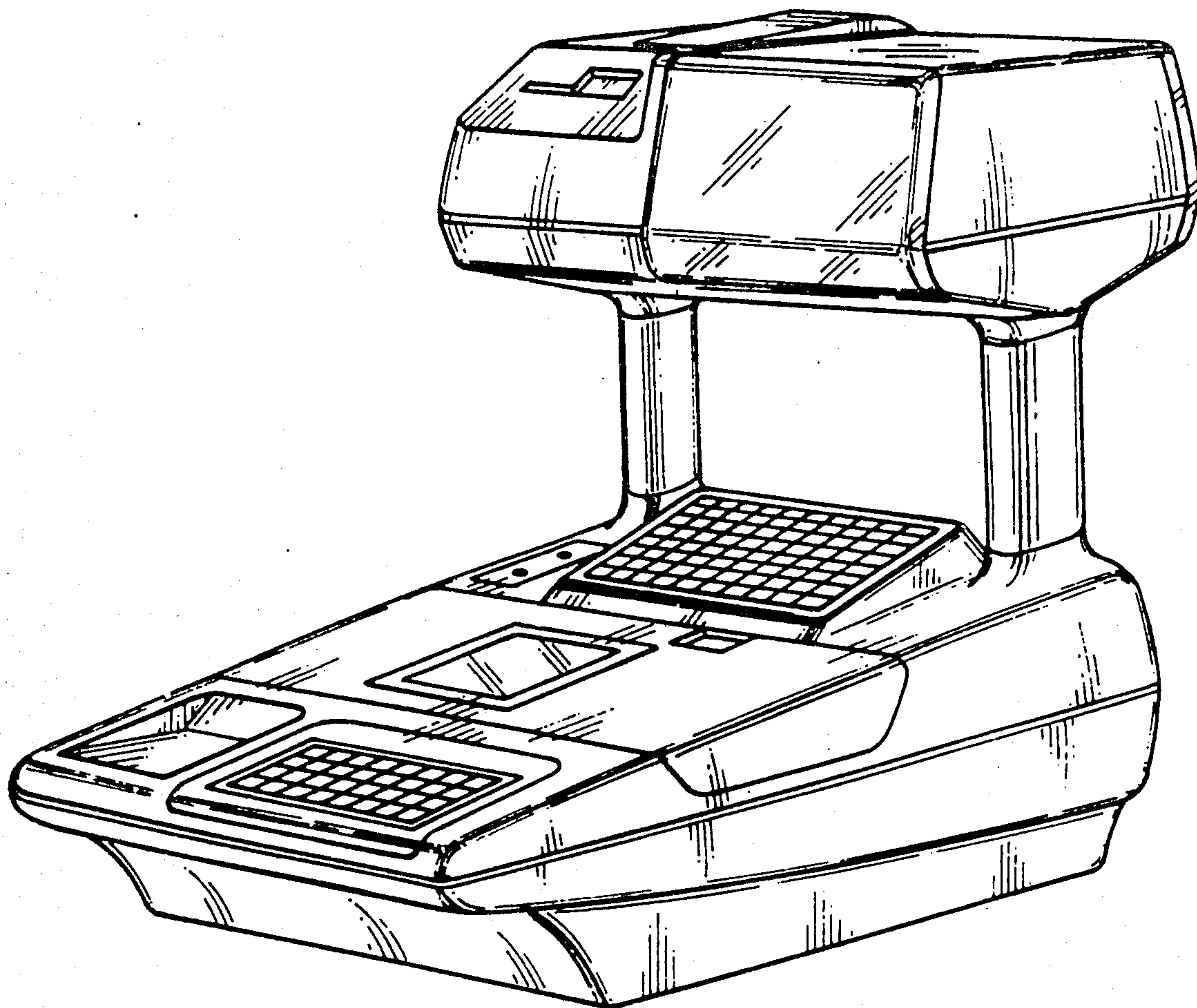

FIG. 1

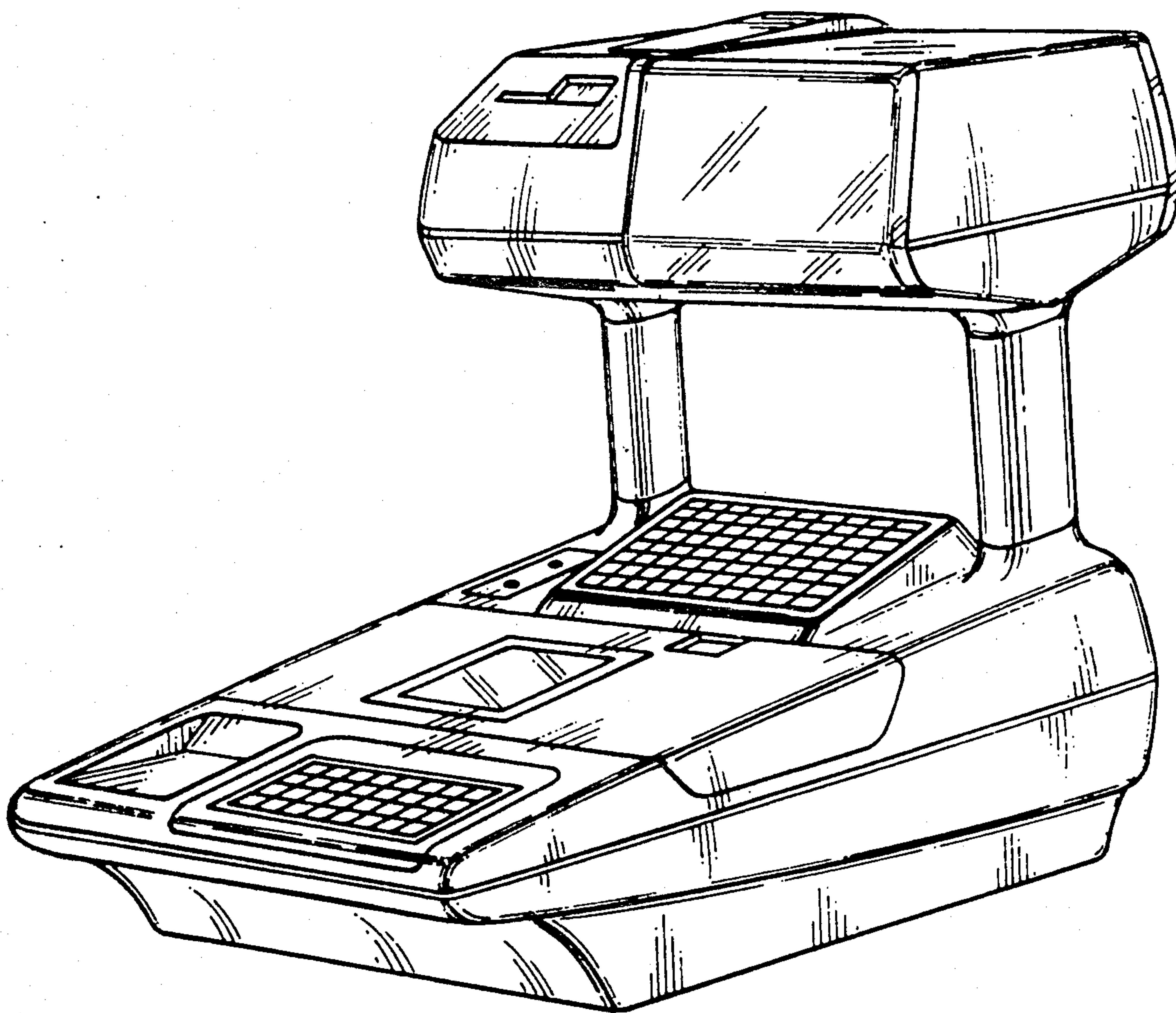

FIG. 2

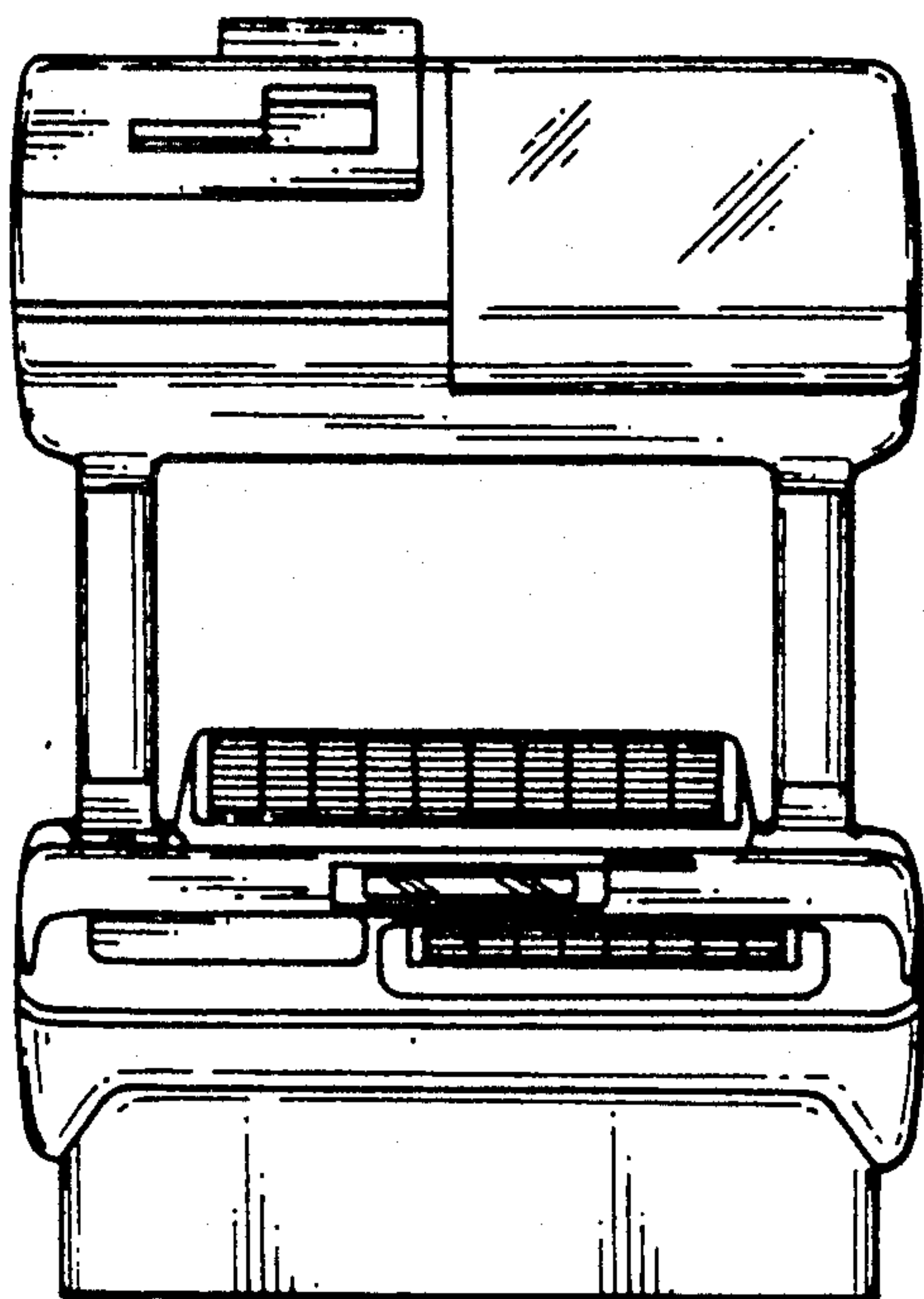

FIG. 3

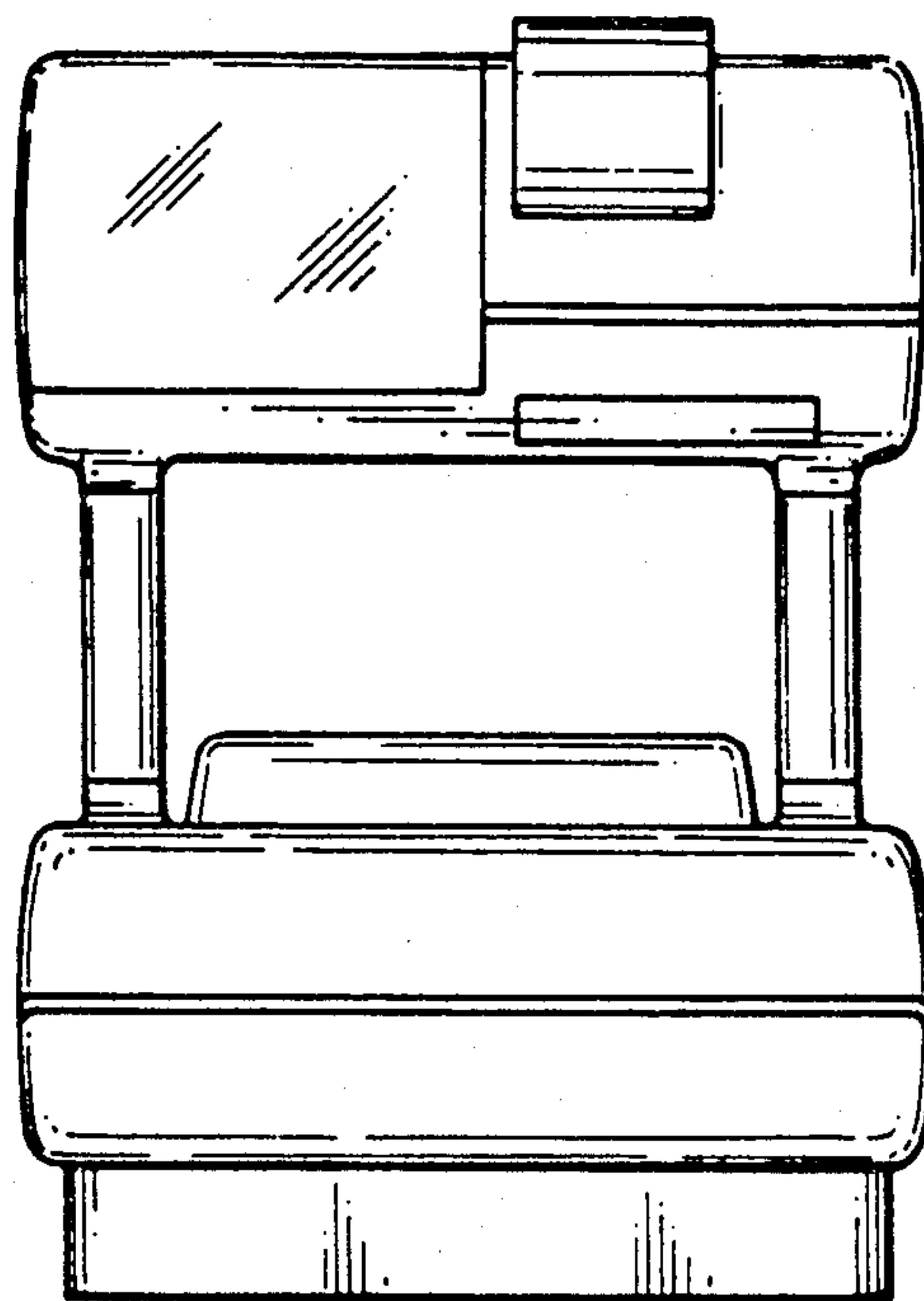

FIG. 4

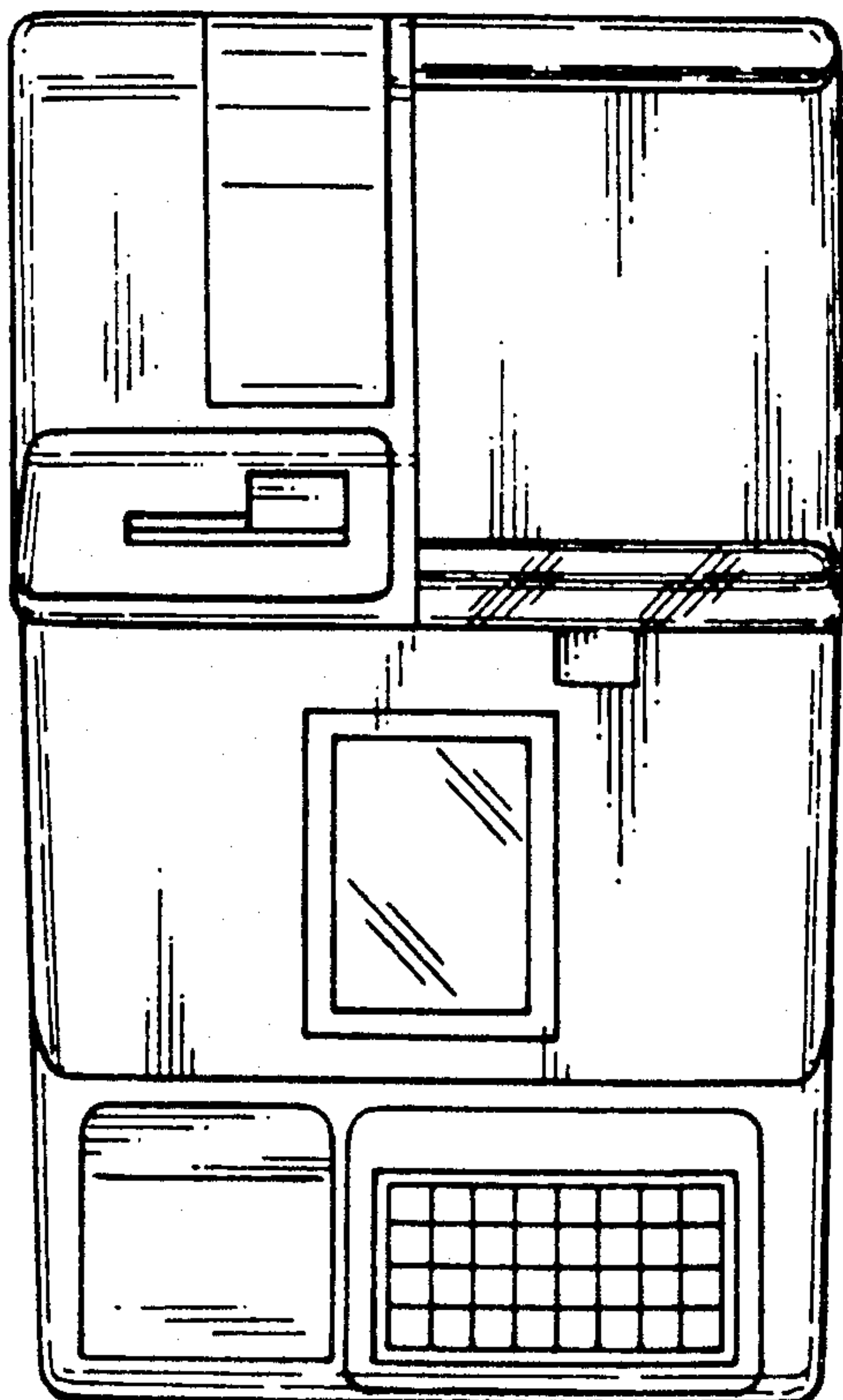

FIG. 5

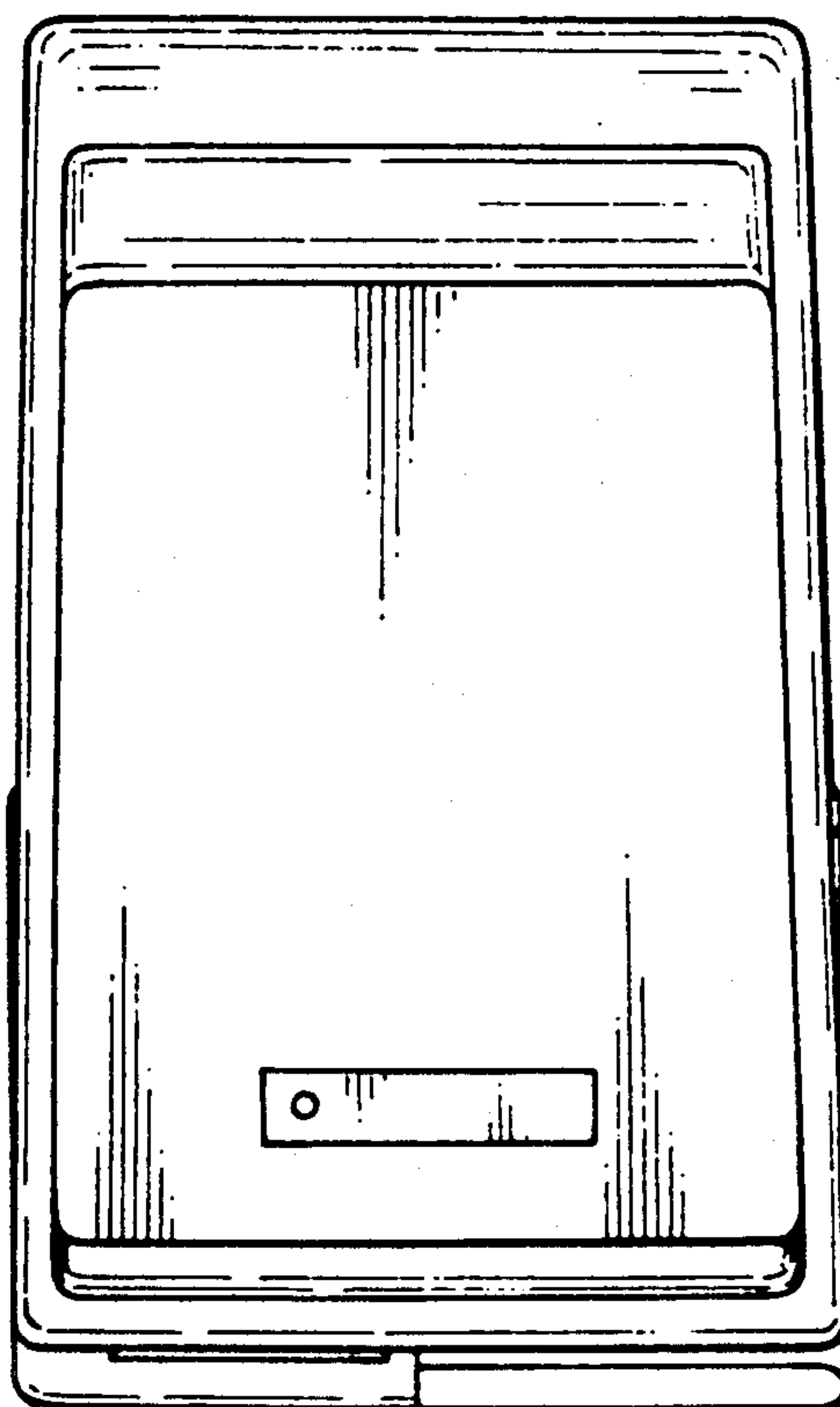

FIG. 6

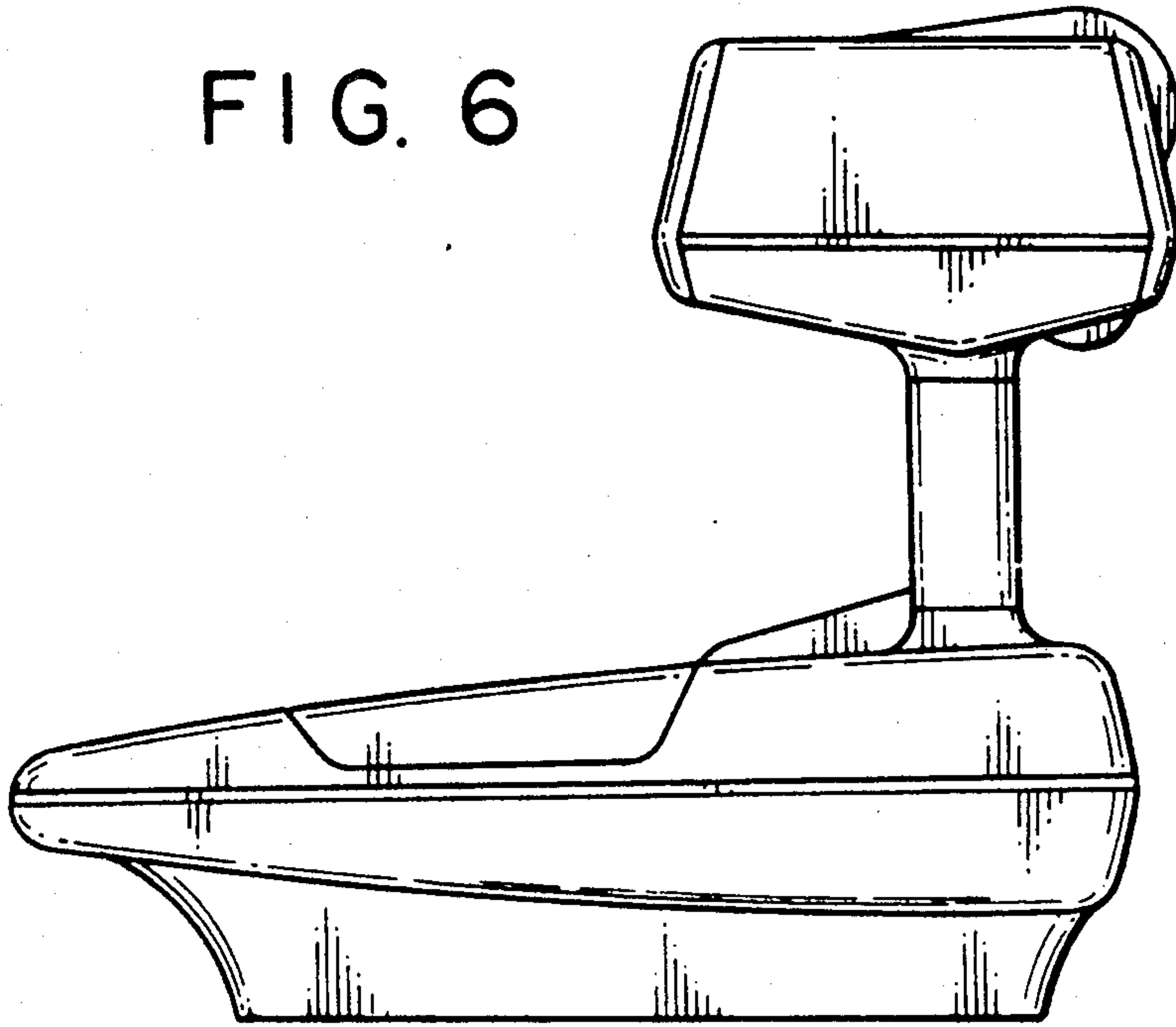

FIG. 7

