

[54] BRUSH STORAGE CONTAINER  
[76] Inventors: Anette G. Krueger; Claus-Dieter Krueger, both of 199 King Street, St. Jacobs, Ontario, Canada, N0B 2N0

[\*\*] Term: 14 Years  
[21] Appl. No.: 337,456  
[22] Filed: Apr. 13, 1989

[30] Foreign Application Priority Data  
Mar. 1, 1989 [CA] Canada ..... 01-03-89-10  
[52] U.S. Cl. .... D9/428; D9/337; D9/341  
[58] Field of Search ..... D9/424, 425, 428, 341, D9/337; D32/53, 53.1, 54, 37; D4/199; D7/538, 541, 542, 612, 614, 360; 206/361, 372, 362, 373, 15.2; 220/4 B, 641, 645, 648, 518, 85 D; D3/30.1; 211/70.6

[56] References Cited  
U.S. PATENT DOCUMENTS  
D. 272,705 2/1984 Gottsegen et al. .... D3/30.1  
D. 284,940 8/1986 Fortuna et al. .... D9/349  
D. 287,051 12/1986 Perkins et al. .... D9/425 X  
2,944,694 7/1960 Kinsey ..... 206/541  
2,945,251 7/1960 Eichner ..... 206/362 X

3,113,690 12/1963 Swenck ..... 206/518 X  
3,266,623 8/1966 Poferl ..... 206/541  
4,155,448 5/1979 Horian et al. .... 206/362  
4,350,245 9/1982 Elstner ..... 206/362 X  
4,550,828 11/1985 Baldwin et al. .... 206/372 X

Primary Examiner—Bernard Ansher  
Assistant Examiner—Prabhakar Deshmukh  
Attorney, Agent, or Firm—Ware, Fressola, Van Der Sluys & Adolphson

[57] CLAIM

The ornamental design for a brush storage container, as shown and described.

DESCRIPTION

FIG. 1 is a perspective view of a brush storage container showing our new design;  
FIG. 2 is an exploded perspective view thereof;  
FIG. 3 is an exploded perspective view thereof; similar to FIG. 2; with brush rack fitting in the base;  
FIG. 4 is a top plan view thereof; in closed position;  
FIG. 5 is a top plan view thereof; with the cover removed;  
FIG. 6 is a front elevation thereof; the rear elevation being a mirror image thereof;  
FIG. 7 is a left side elevation thereof; the right side elevation being a mirror image thereof; and  
FIG. 8 is a bottom plan view thereof.

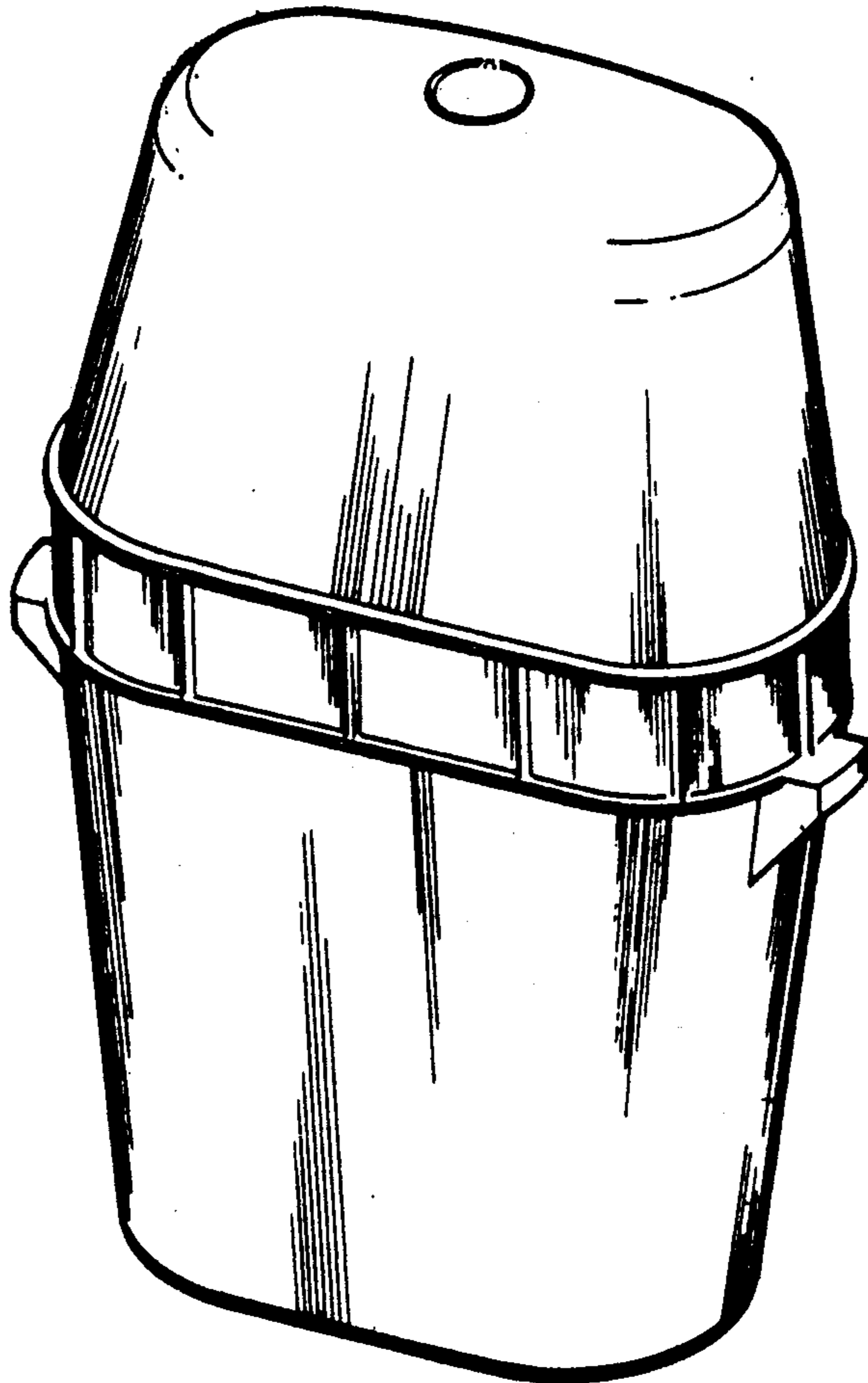

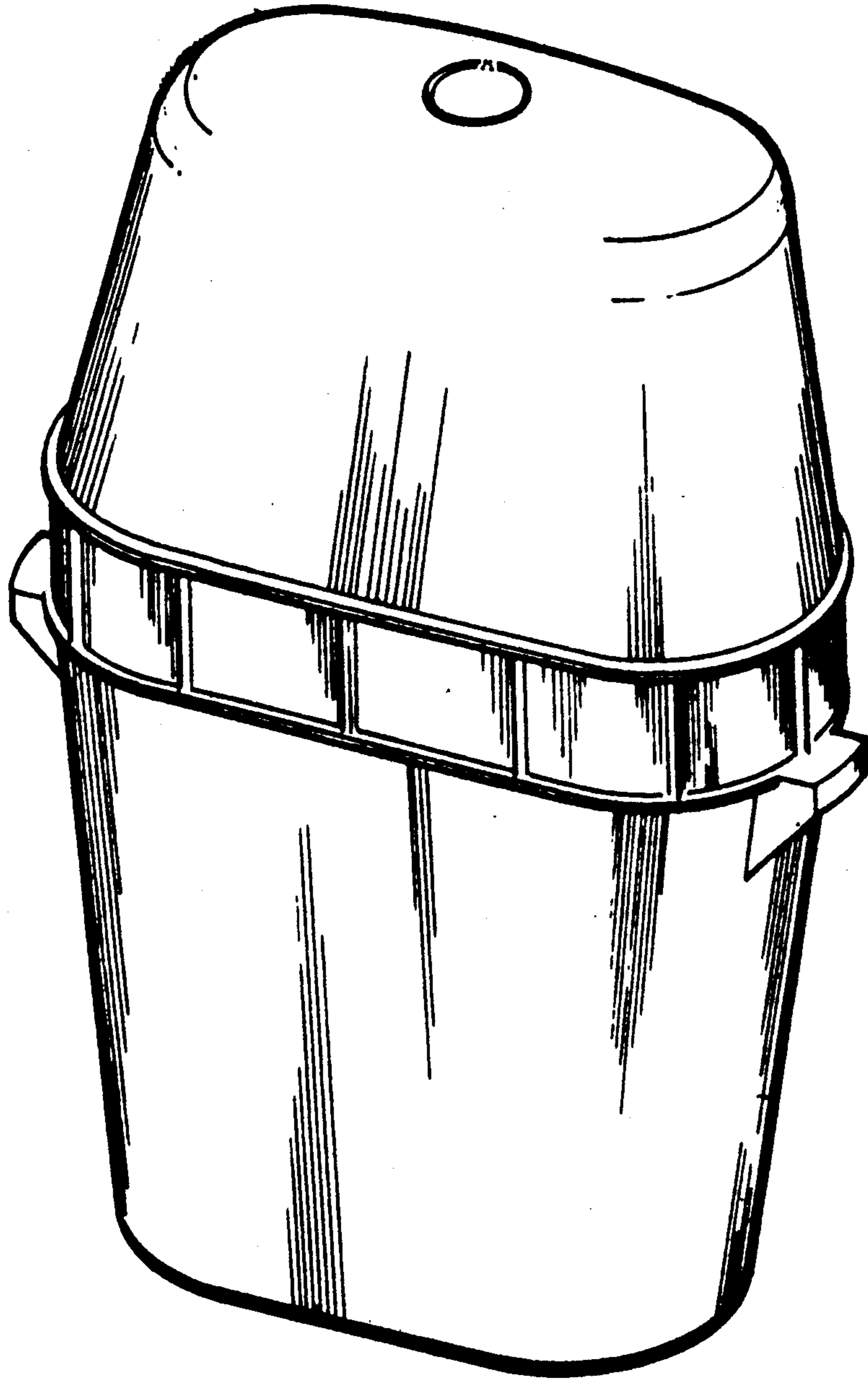

Fig. 1

FIG. 2

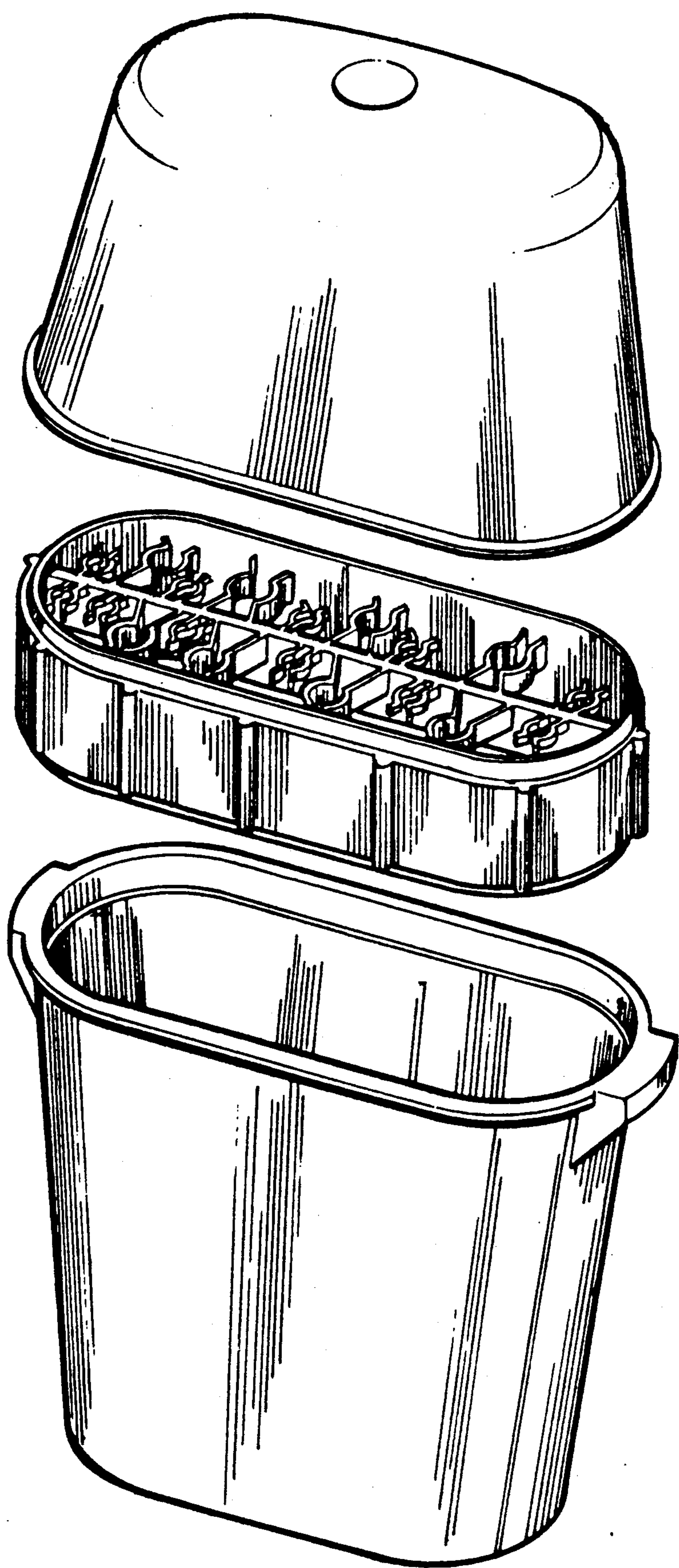
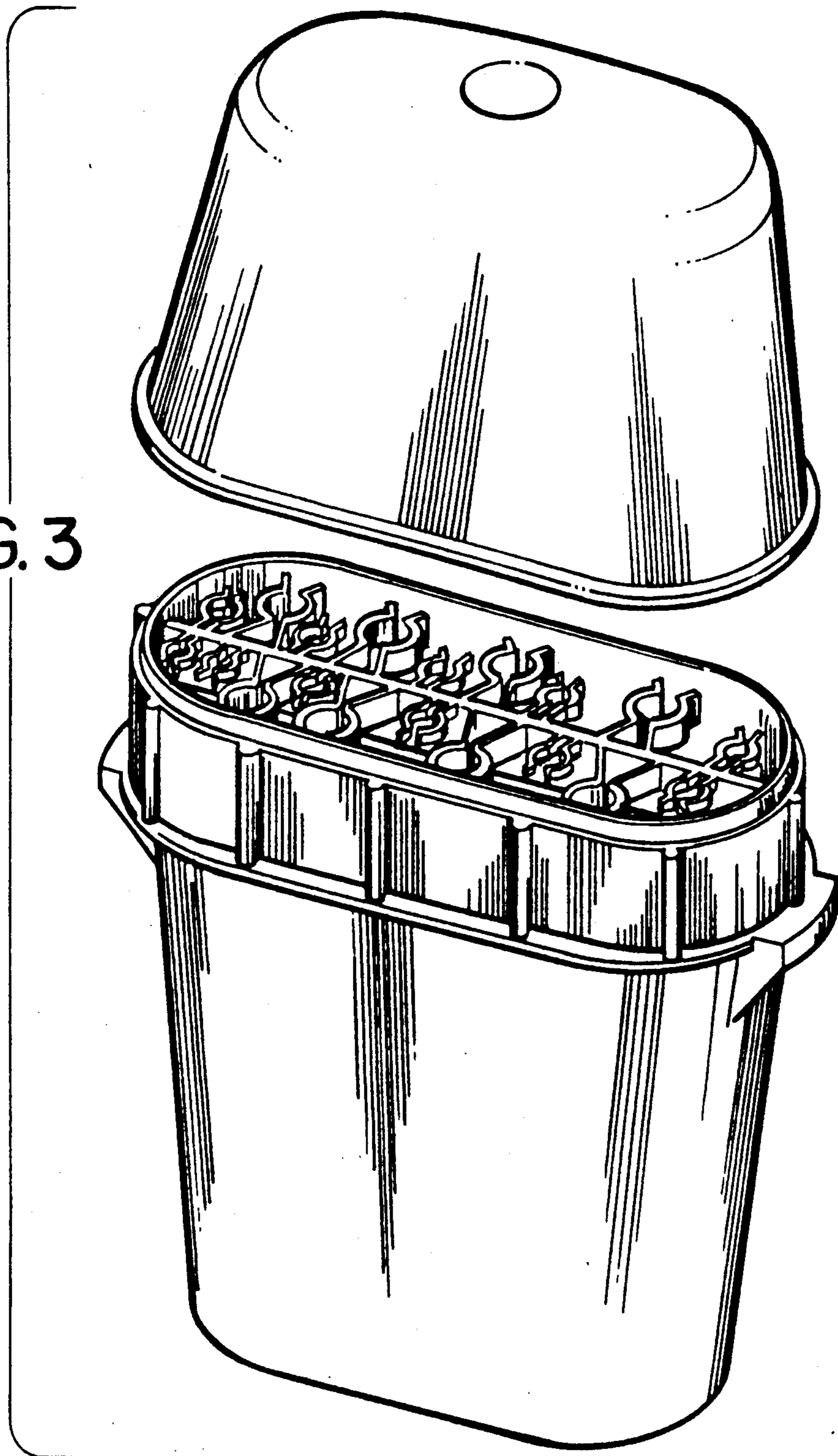



FIG. 3



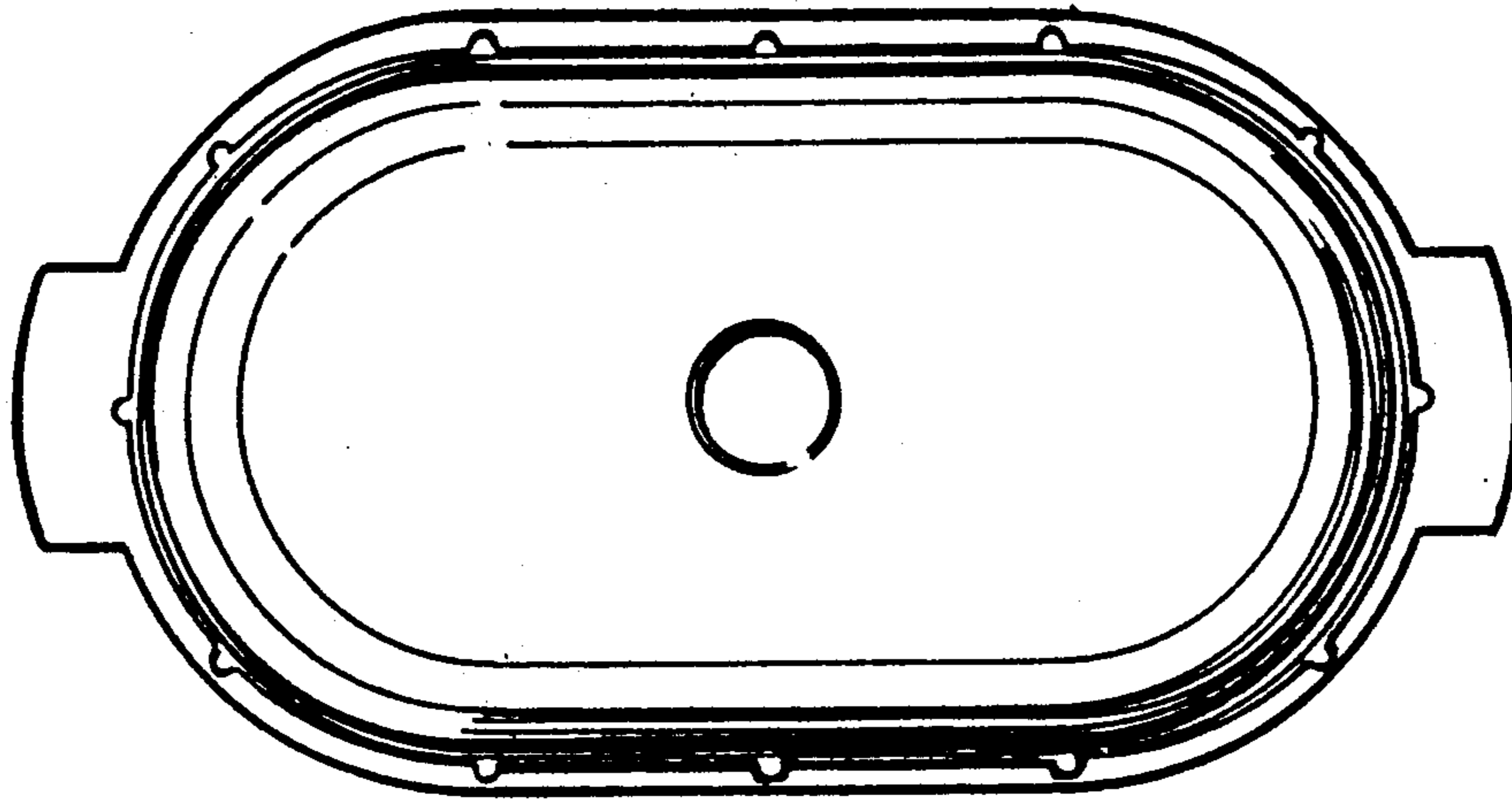

FIG. 4

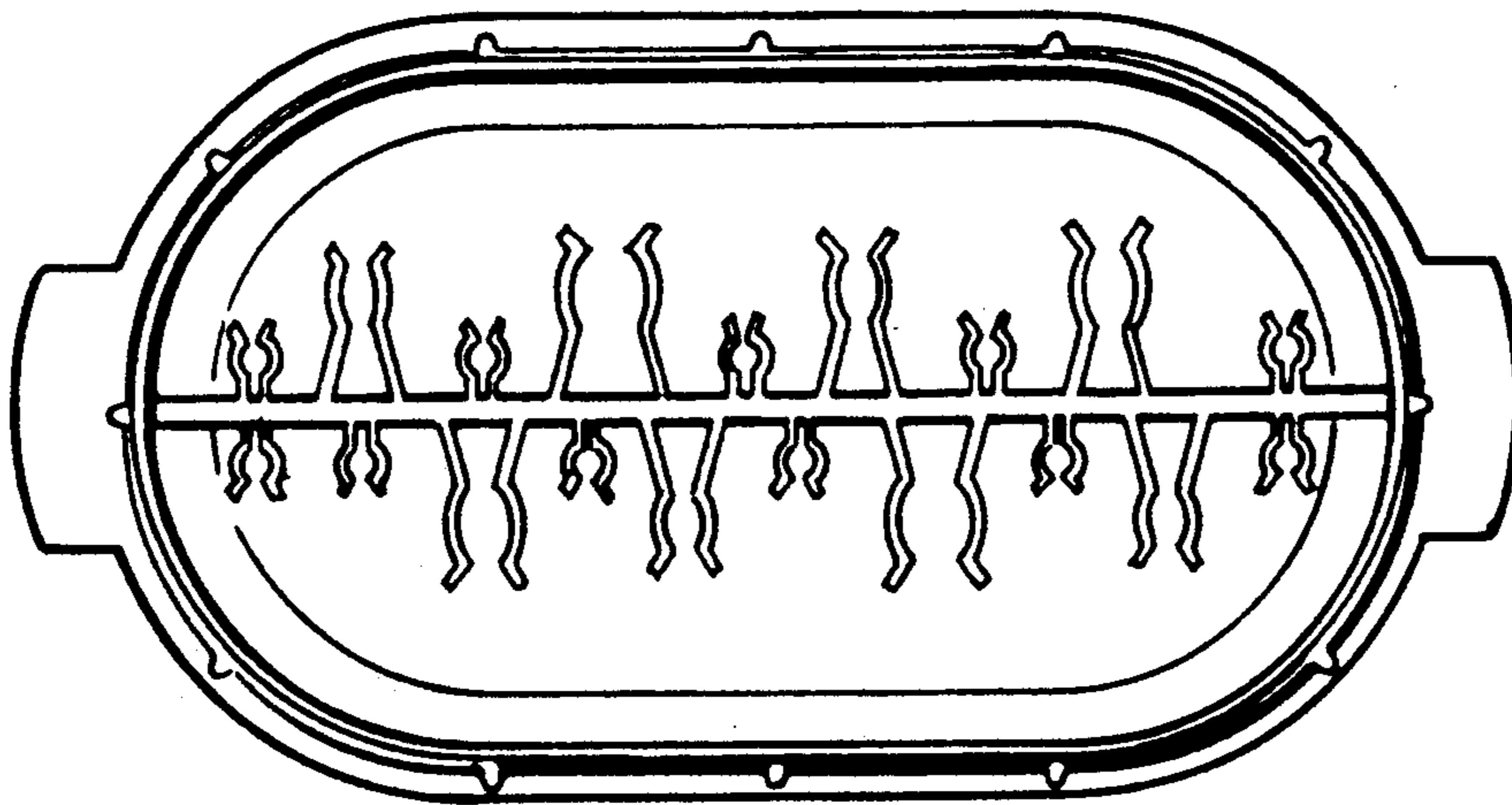

FIG. 5

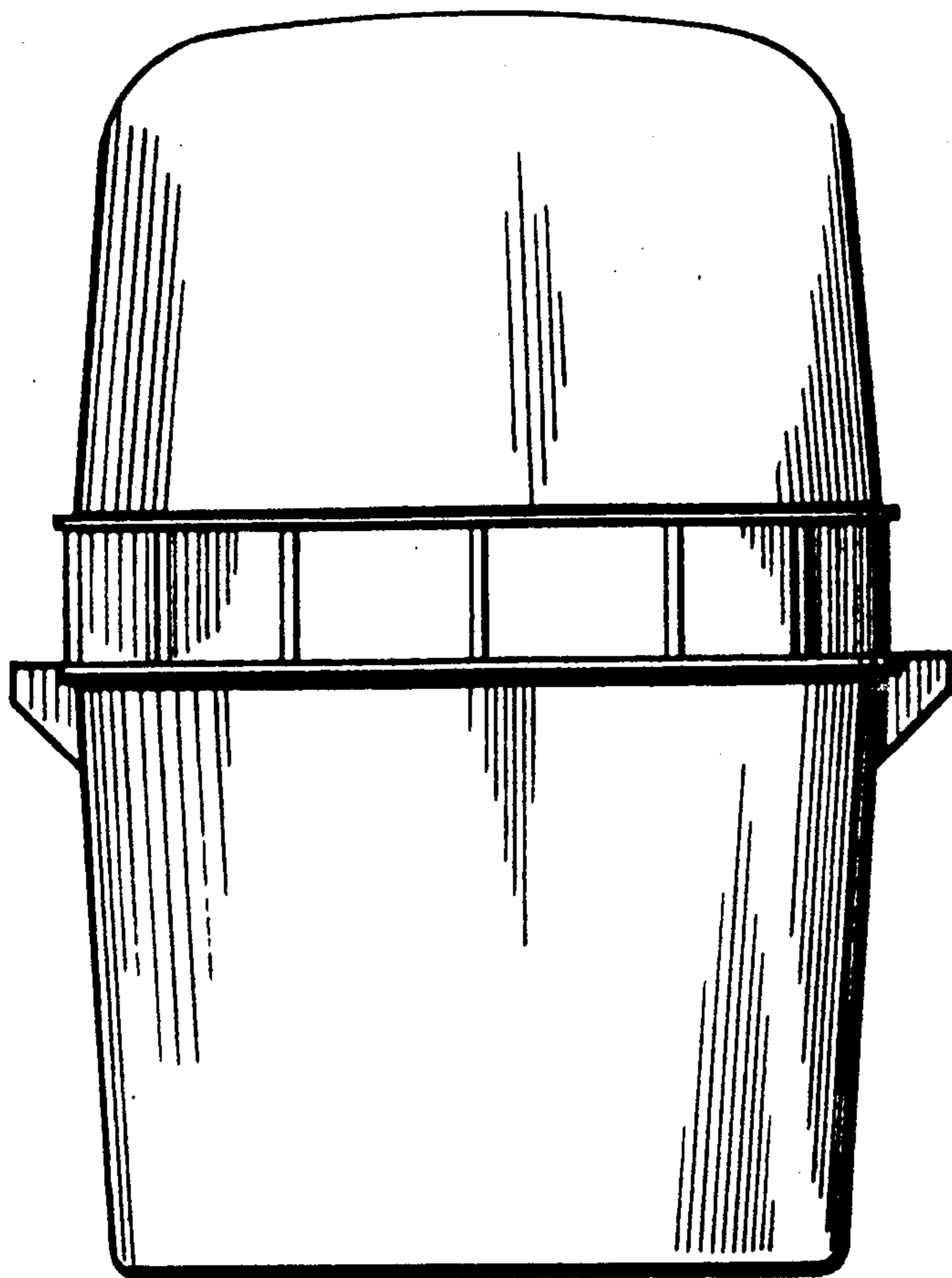

Fig. 6

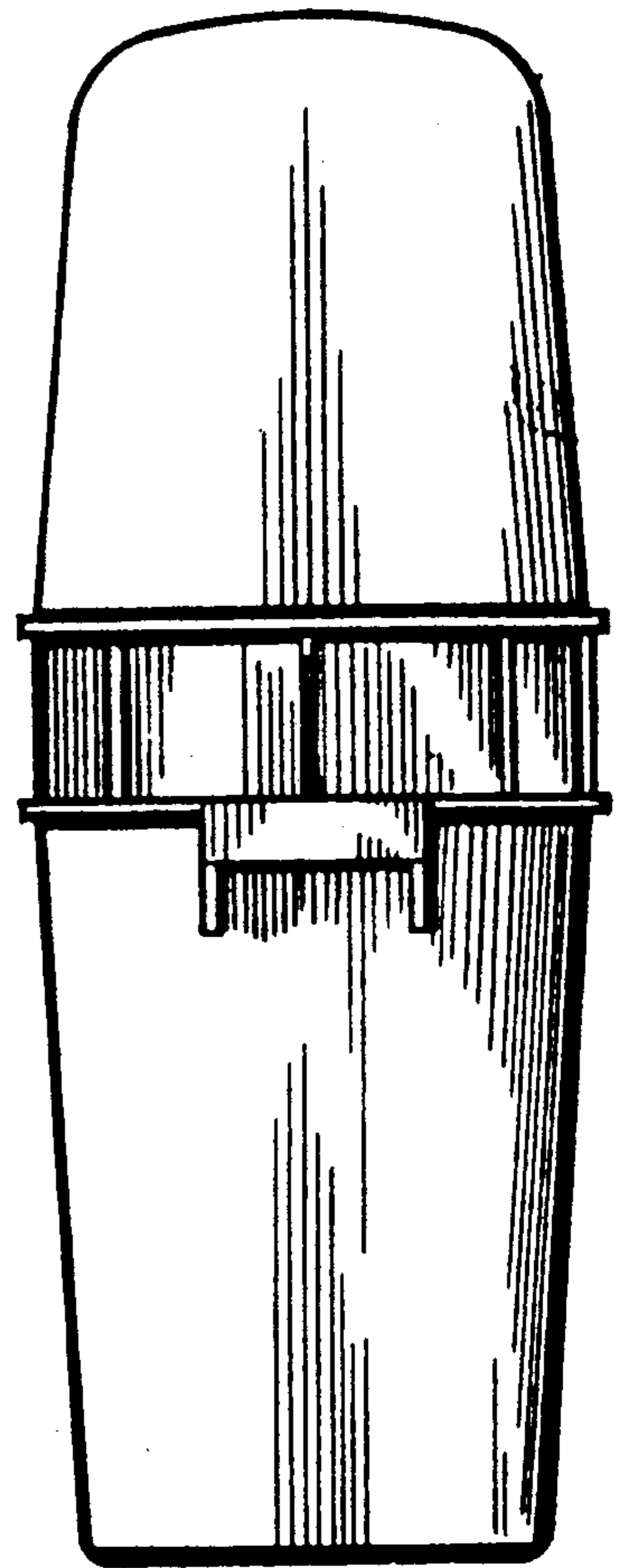

Fig. 7

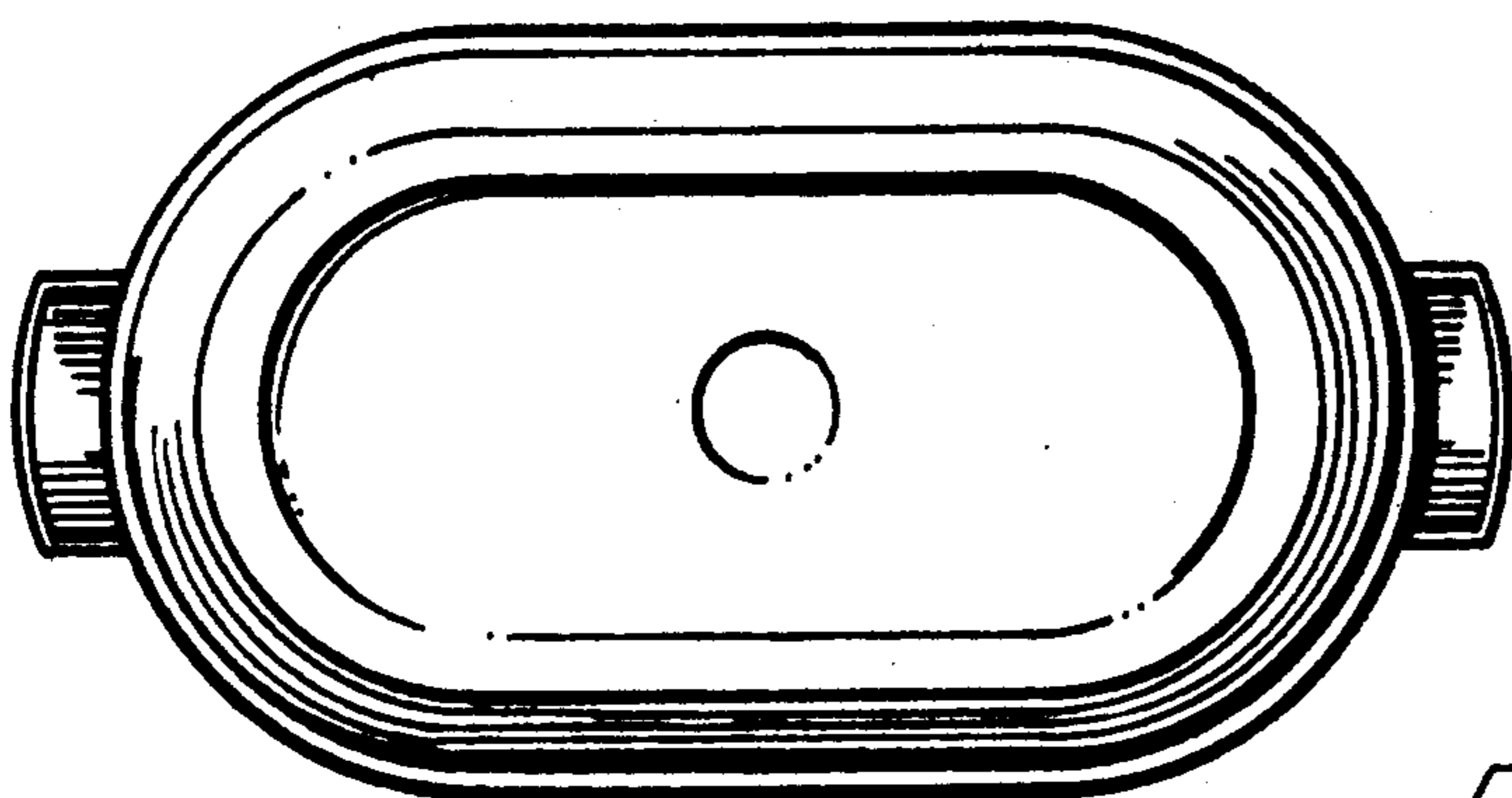

Fig. 8