

[54] HOUSING FOR AN ELECTRICAL CONNECTOR

[75] Inventors: Toshihiko Makita; Takao Murakami, both of Kosai, Japan

[73] Assignee: Yazaki Corporation, Japan

[\*\*] Term: 14 Years

[21] Appl. No.: 150,713

[22] Filed: Feb. 1, 1988

[30] Foreign Application Priority Data

Jul. 31, 1987 [JP] Japan ..... 62-30894

Jul. 31, 1987 [JP] Japan ..... 62-030895

[52] U.S. Cl. .... D13/147

[58] Field of Search ..... D13/133, 146; 439/344, 439/353, 357, 660, 682, 685, 686, 687, 695, 696, 712, 713, 586

[56] References Cited

U.S. PATENT DOCUMENTS

D. 264,072 4/1982 Jonsson ..... D13/24

D. 272,144 1/1984 Mayumi ..... D13/24

D. 277,750 2/1985 Ito et al. .... D13/24

3,501,736 3/1970 Norris ..... 439/353

4,200,350 4/1980 Zimmerman, Jr. .... 439/357

4,721,482 1/1988 Fukuda et al. .... 439/586

Primary Examiner—Susan J. Lucas

Assistant Examiner—Joel Sincavage

Attorney, Agent, or Firm—Jones, Askeew & Lunsford

[57] CLAIM

The ornamental design for a housing for an electrical connector, as shown and described.

DESCRIPTION

FIG. 1 is a perspective view of a housing for an electrical connector showing our new design;

FIG. 2 is a top plan view thereof;

FIG. 3 is a front elevation view thereof;

FIG. 4 is a rear elevation view thereof;

FIG. 5 is a bottom plan view thereof;

FIG. 6 is a right elevation view thereof, the left side elevation view being a mirror image;

FIG. 7 is a section view taken at line 7—7 of FIG. 3;

FIG. 8 is a section view taken at line 8—8 of FIG. 3;

FIG. 9 is a perspective view of a housing for an electrical connector showing a second embodiment of our new design;

FIG. 10 is a top plan view thereof;

FIG. 11 is a front elevation view thereof;

FIG. 12 is a rear elevation view thereof;

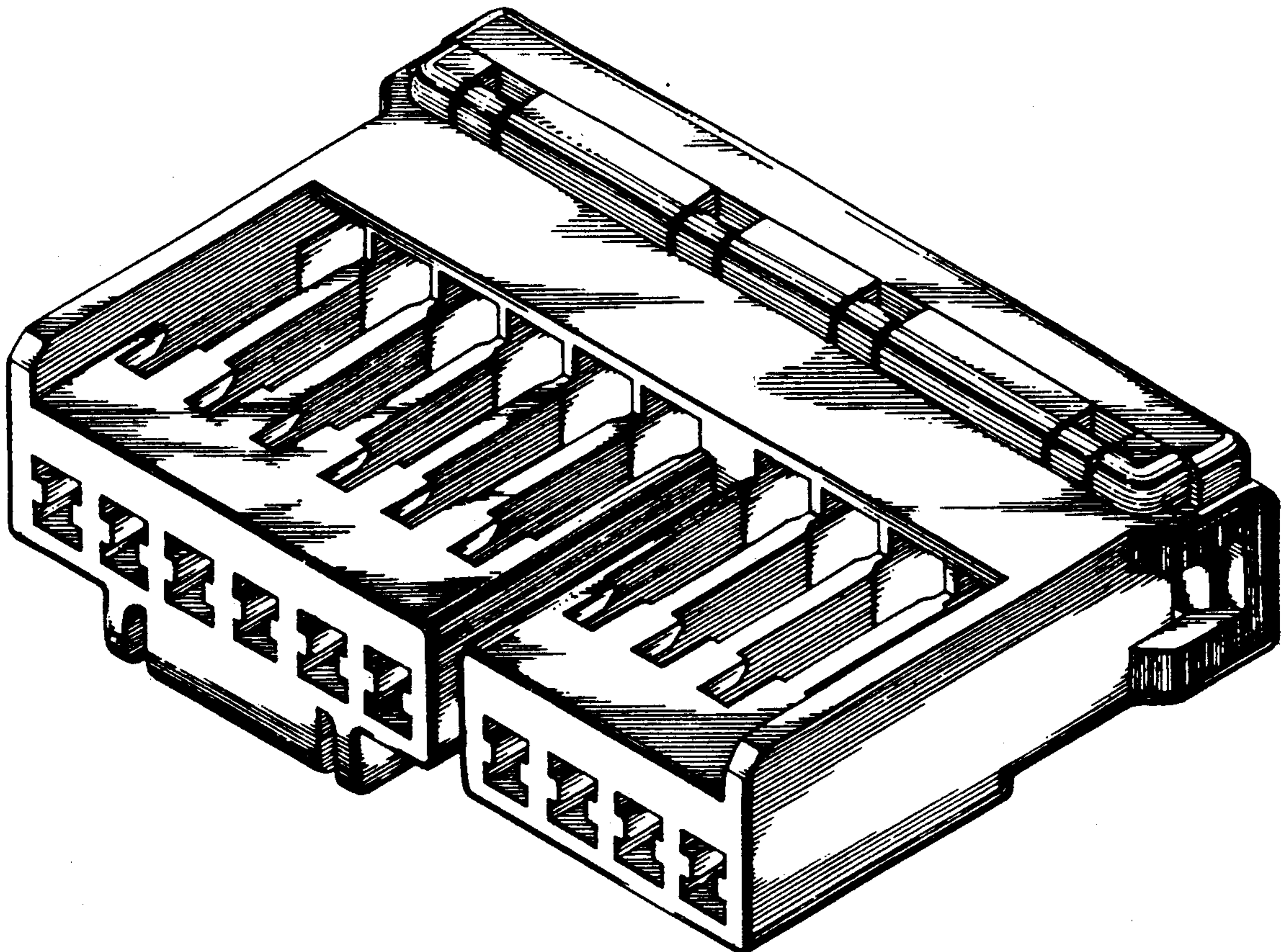
FIG. 13 is a bottom plan view thereof;

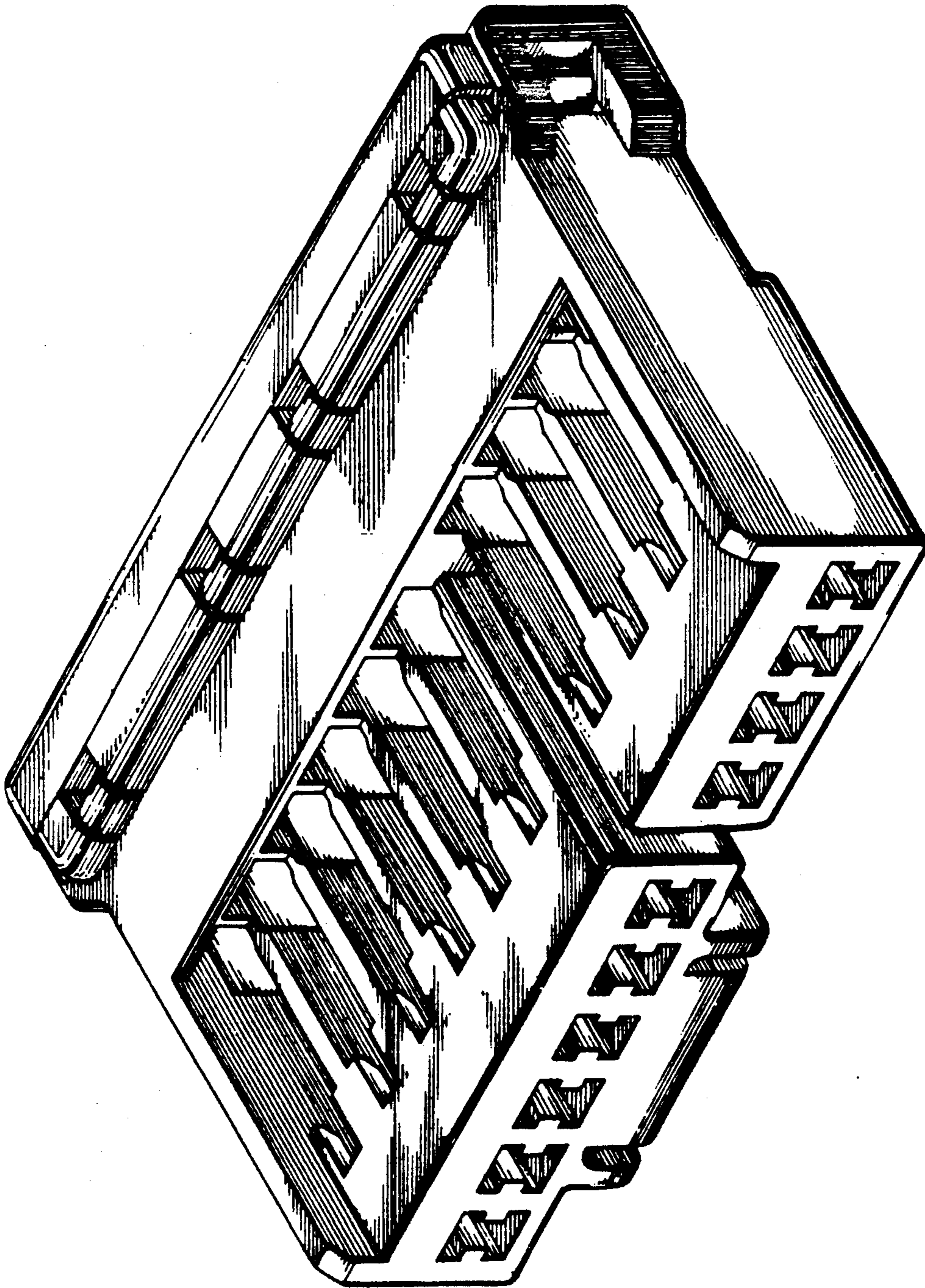
FIG. 14 is a right elevation view thereof, the left side elevation view being a mirror image;

FIG. 15 is a section view taken at line 15—15 of FIG. 11;

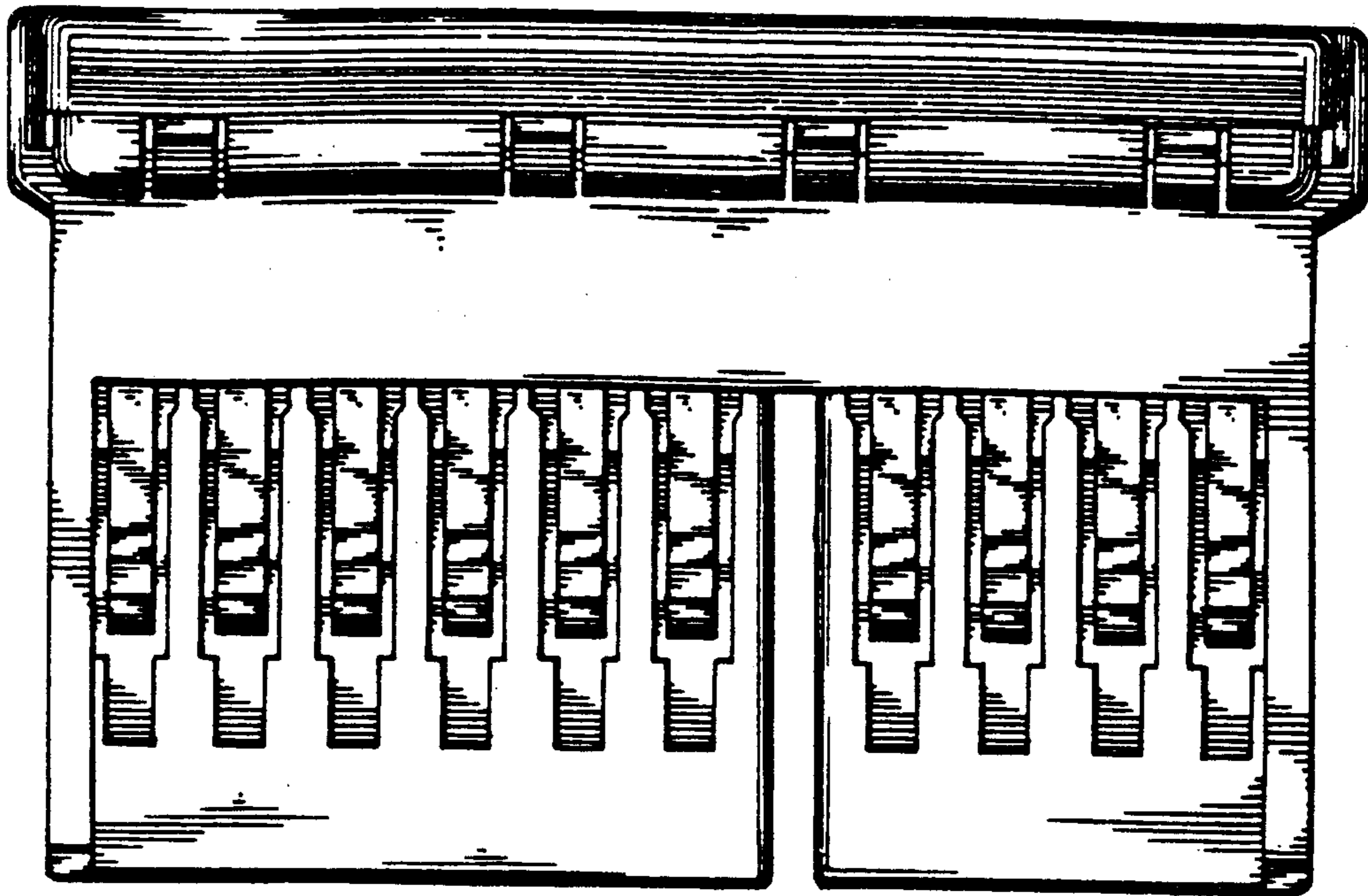
FIG. 16 is a section view taken at line 16—16 of FIG. 11;

FIG. 17 is a section view taken at line 17—17 of FIG. 11.

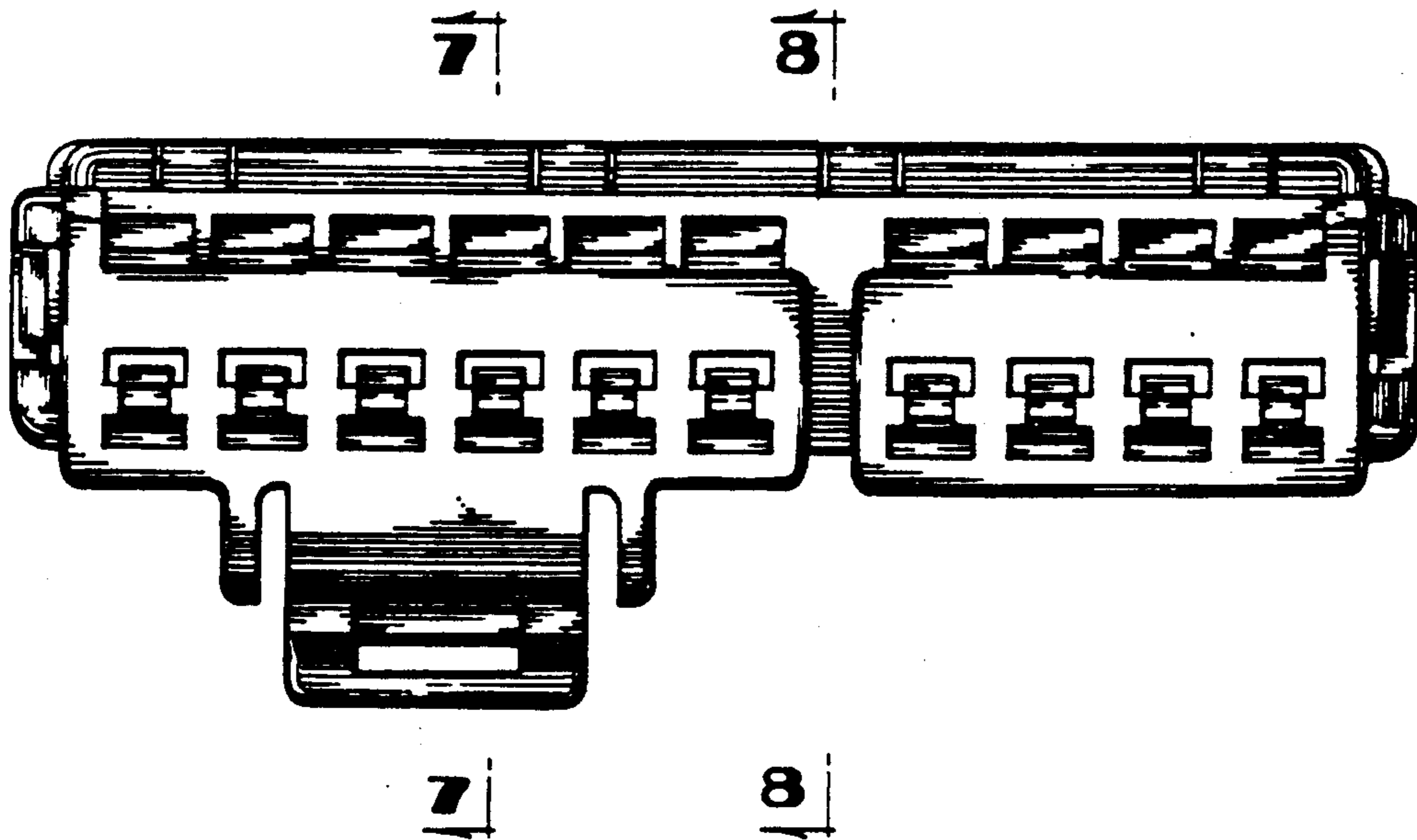




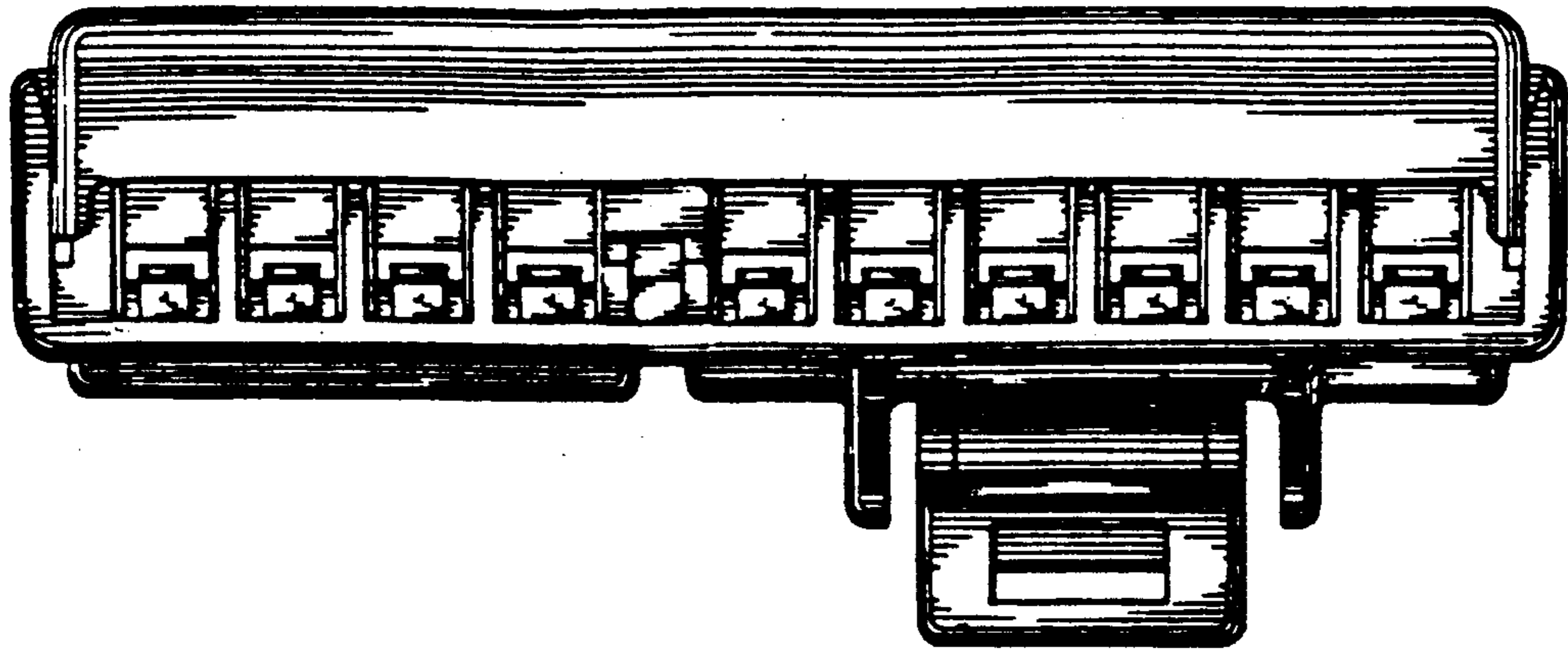
**FIG 1**



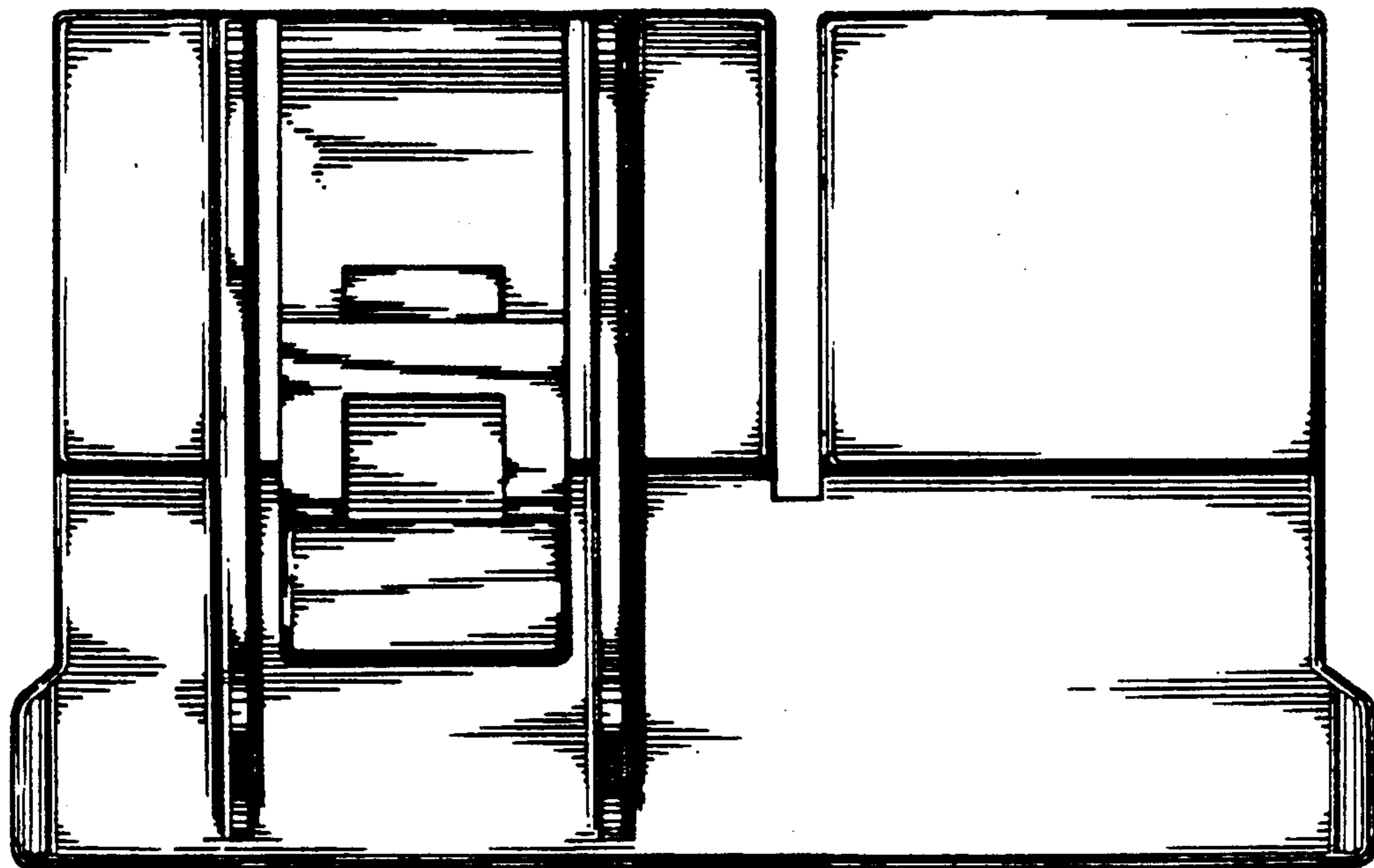
**FIG 2**



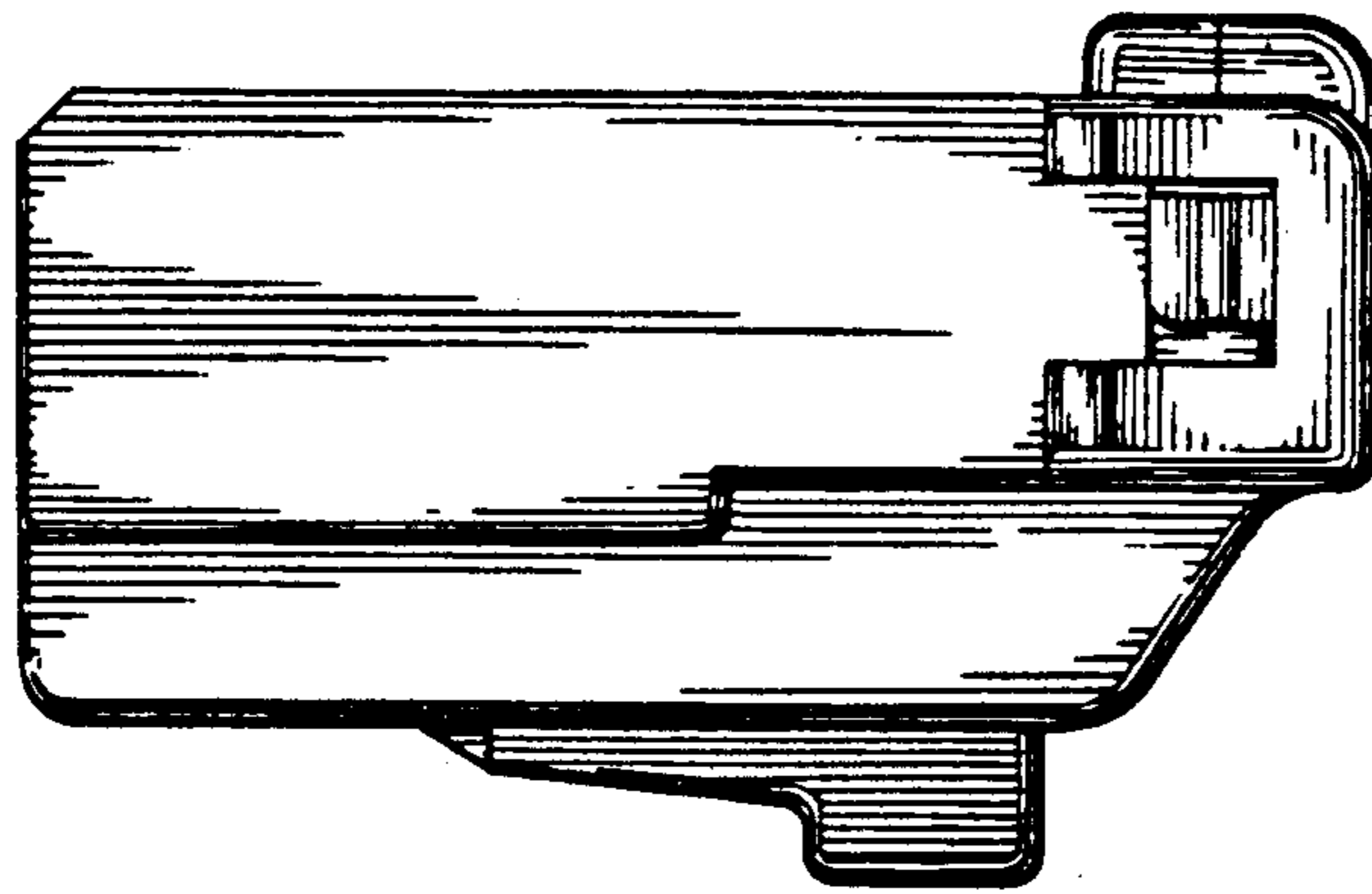
**FIG 3**



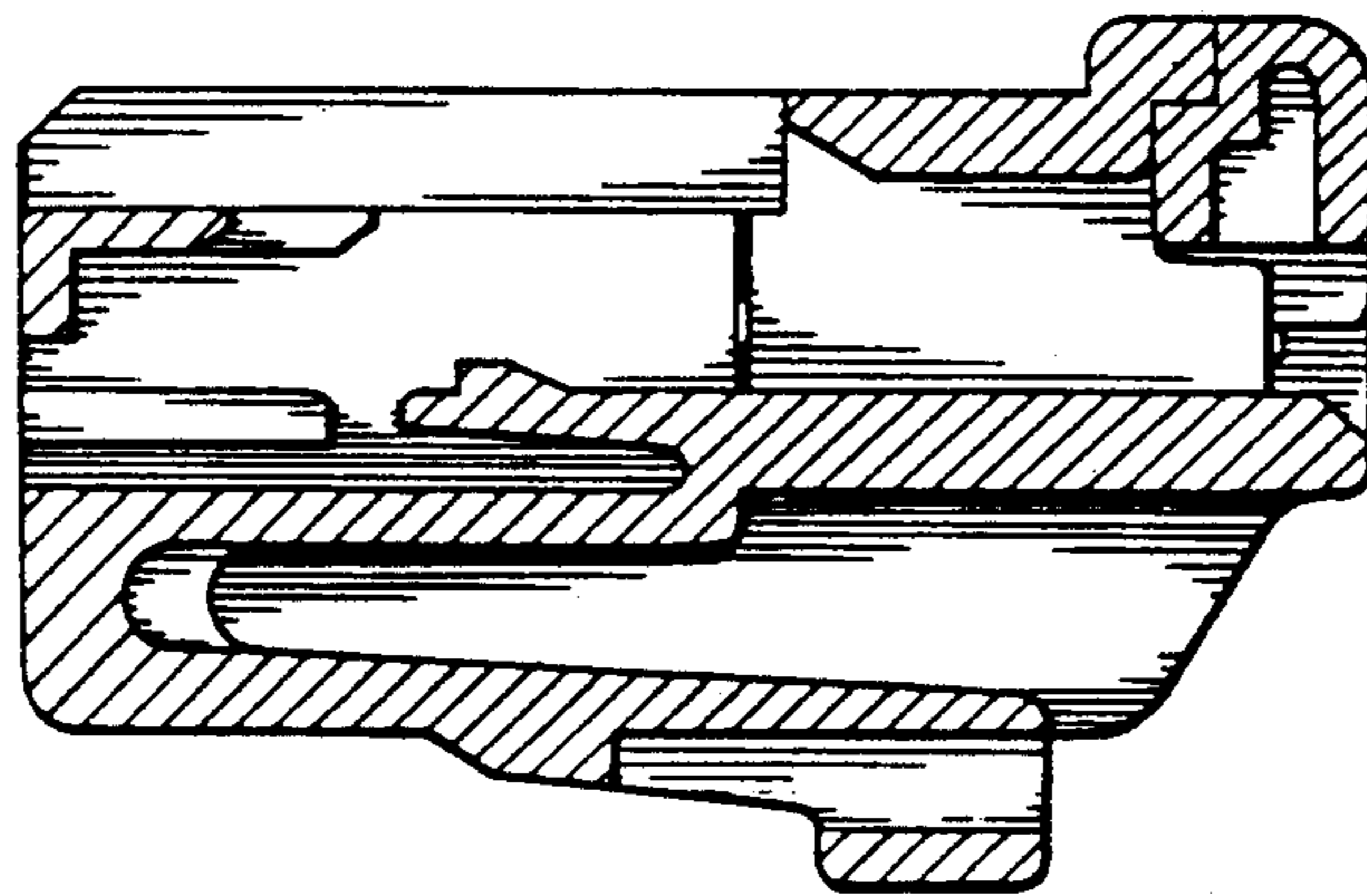
**FIG 4**



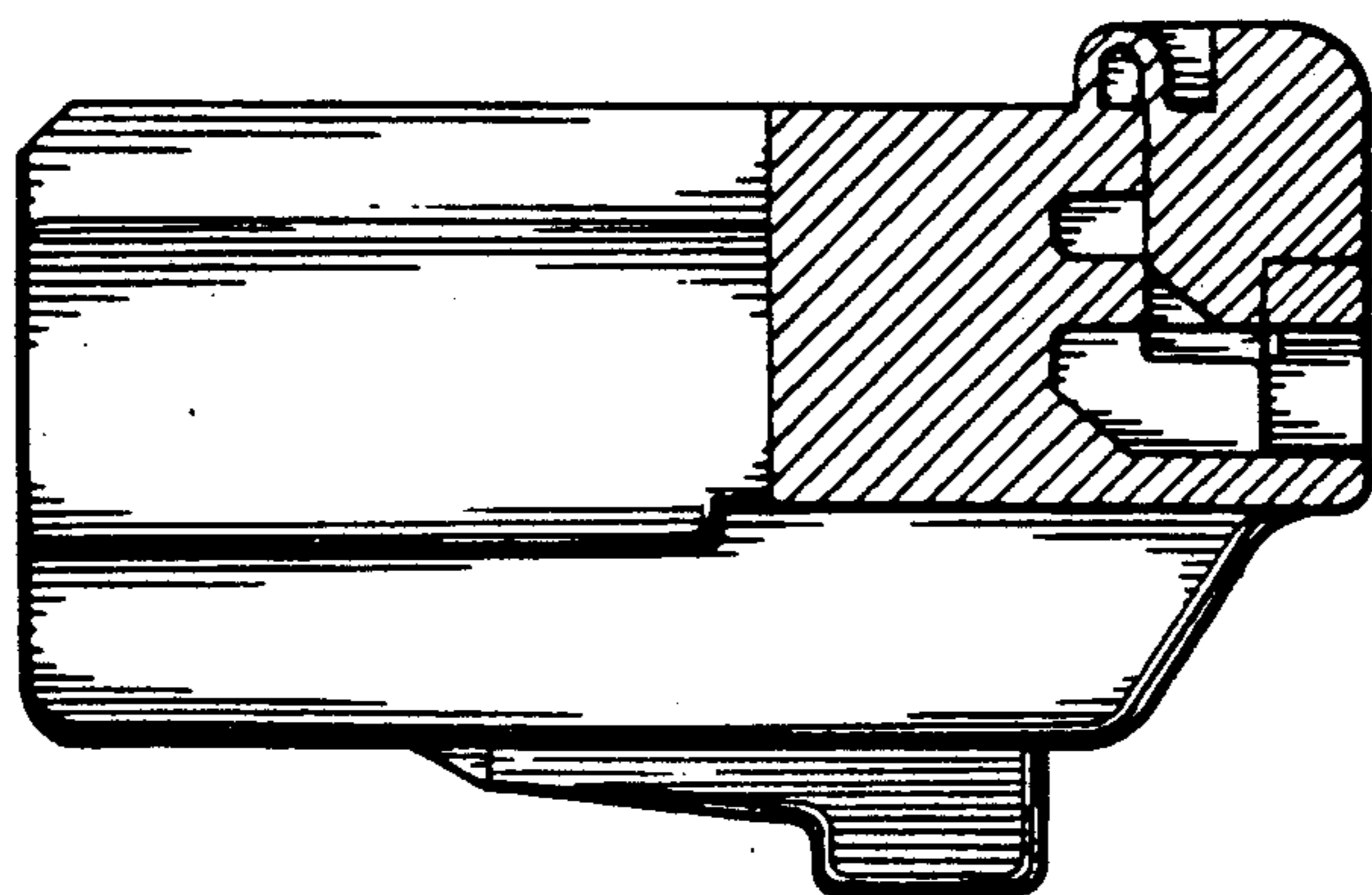
**FIG 5**



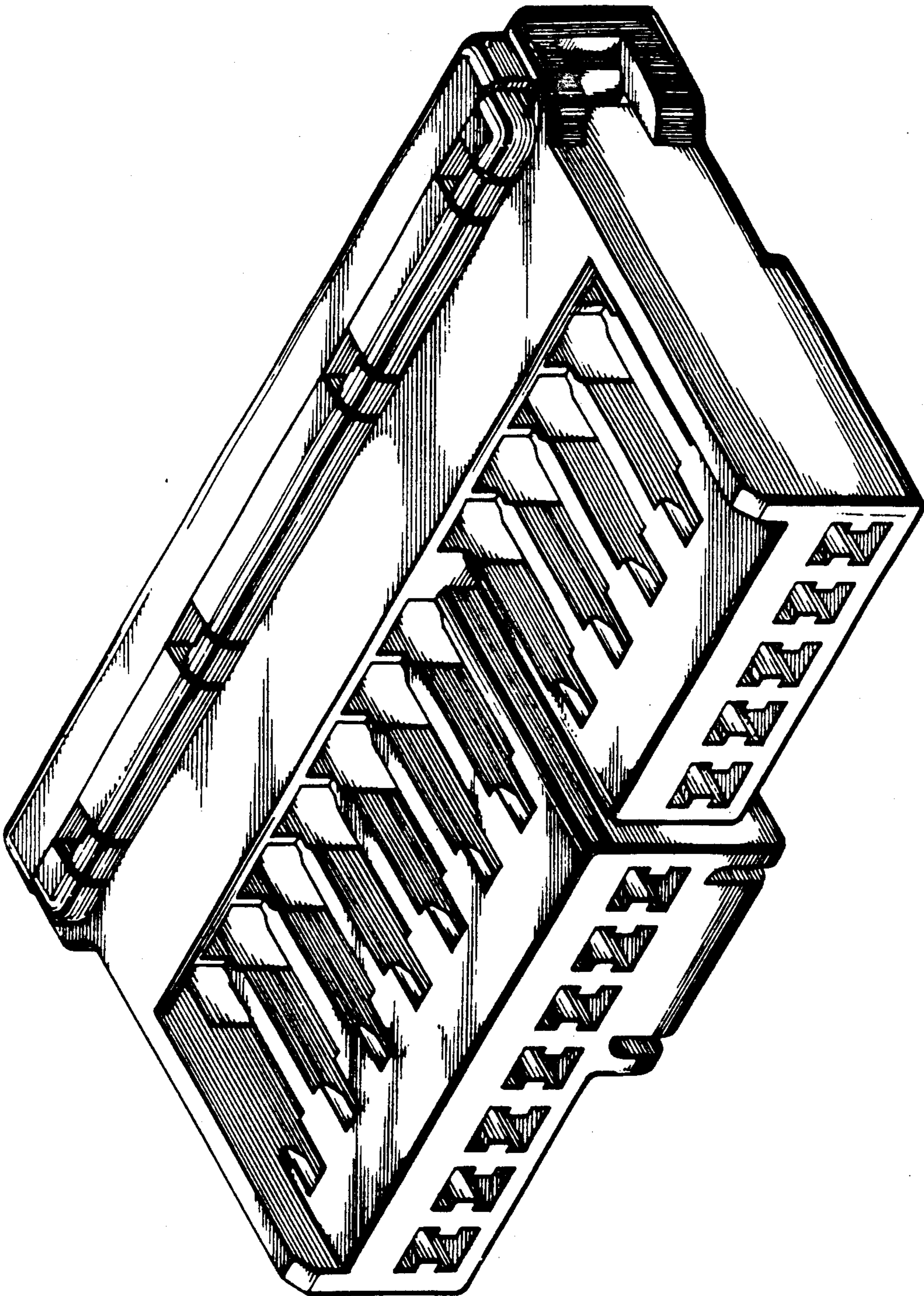
**FIG 6**



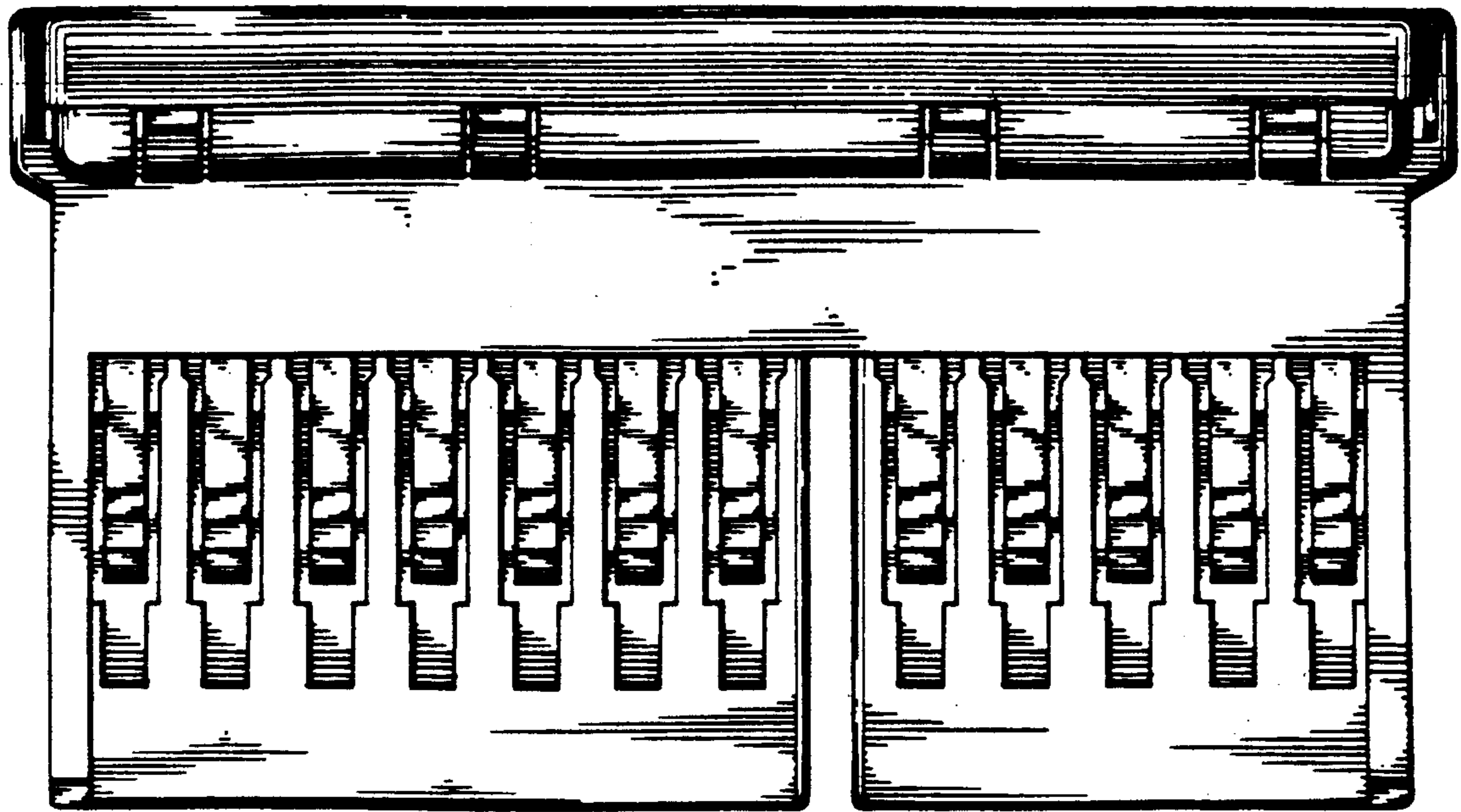
**FIG 7**



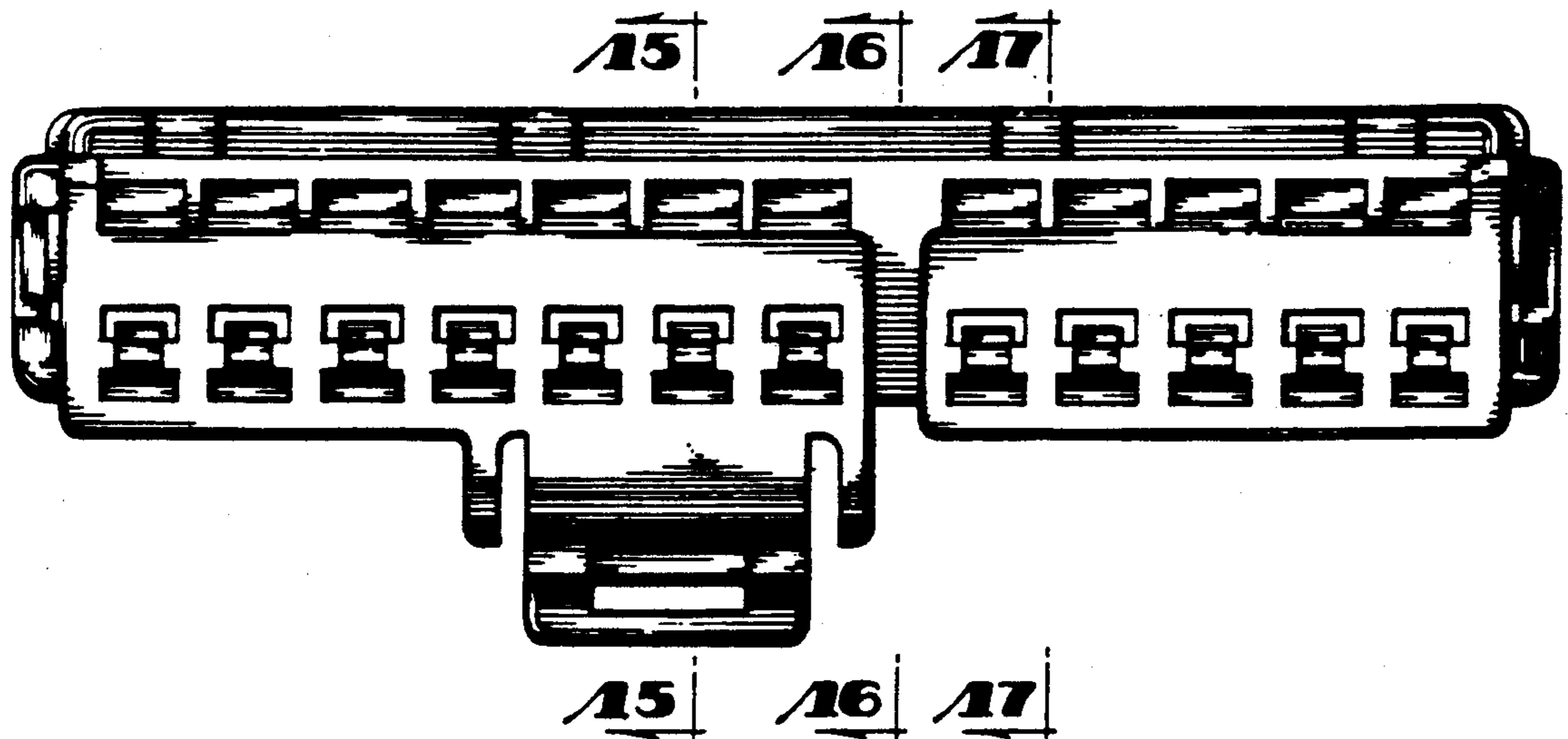
**FIG 8**



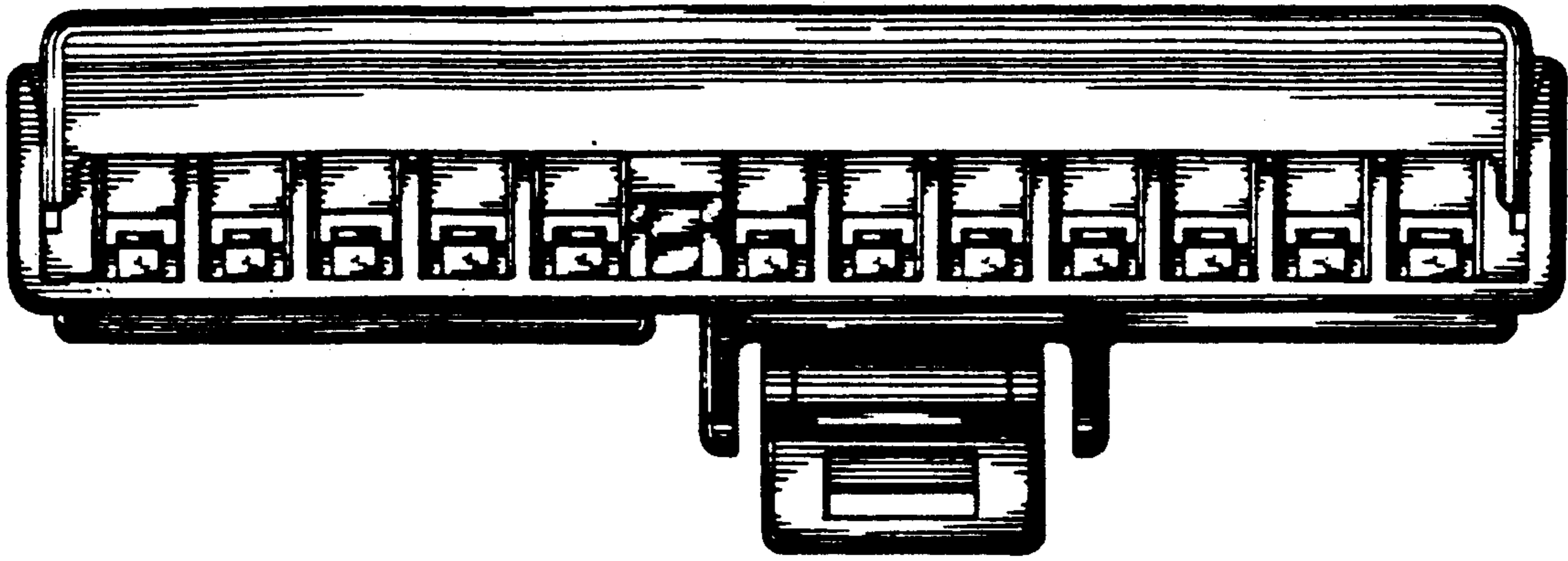
**FIG 9**



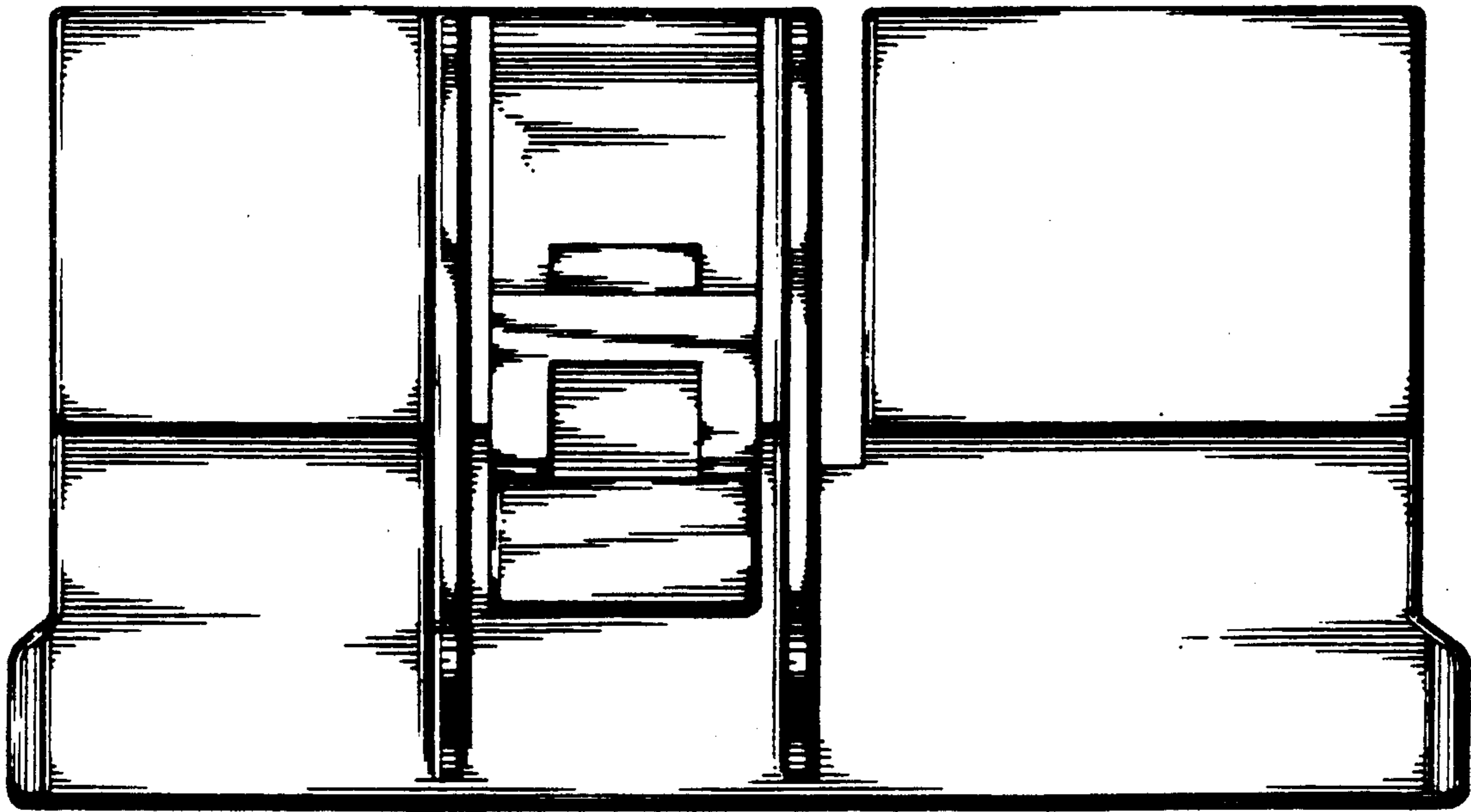
**FIG 10**



**FIG 11**

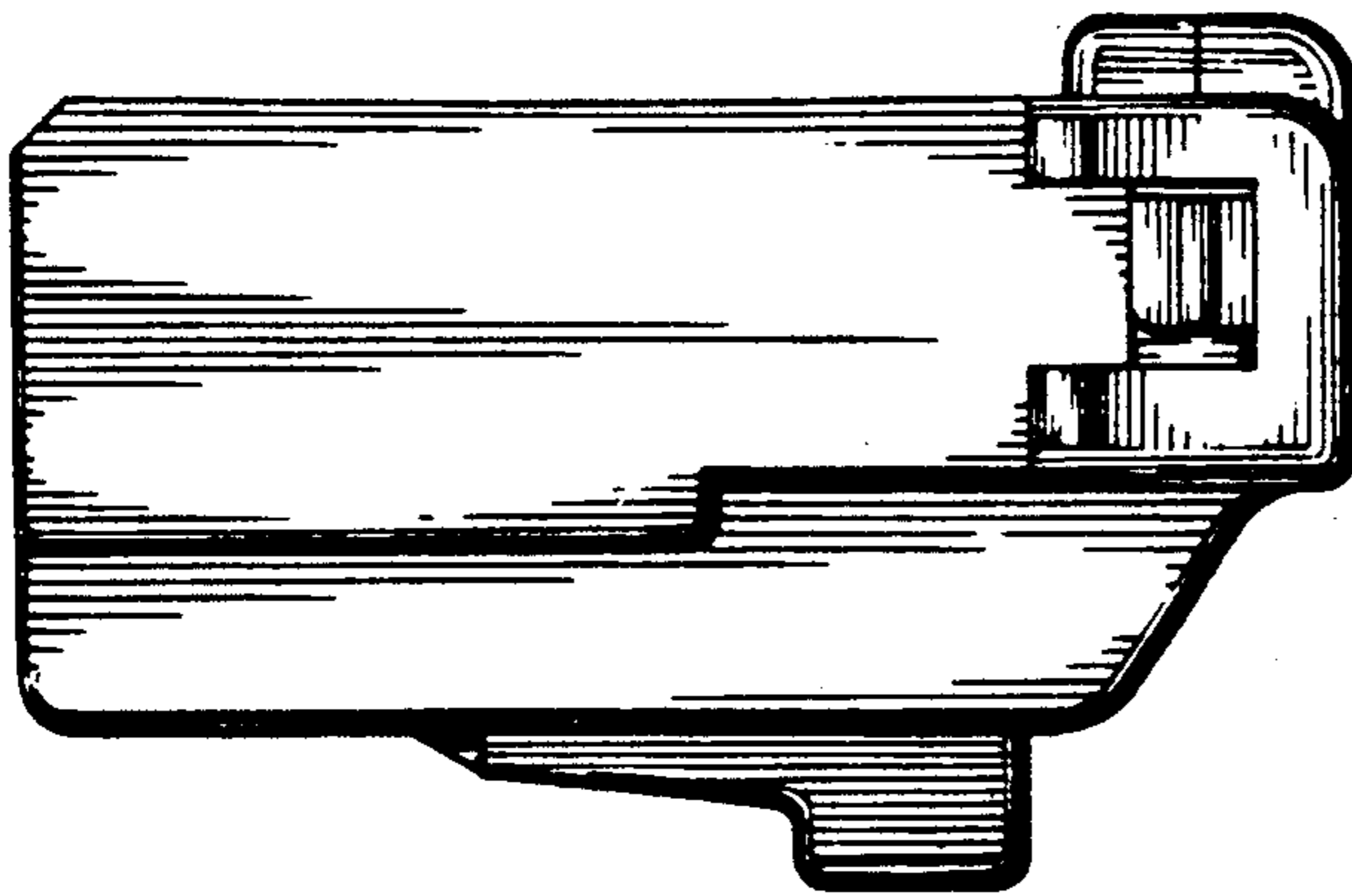


**FIG 12**

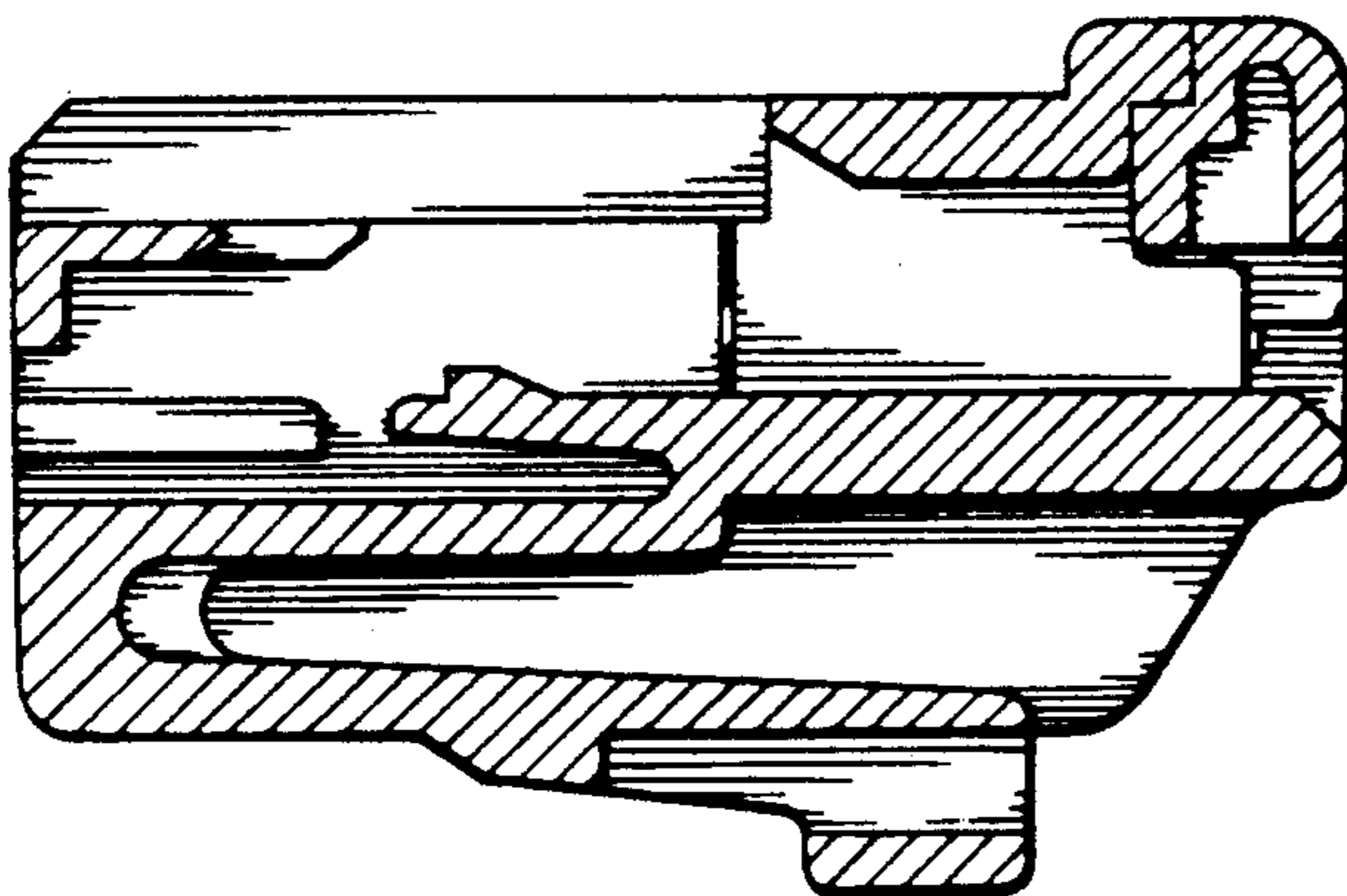


**FIG 13**

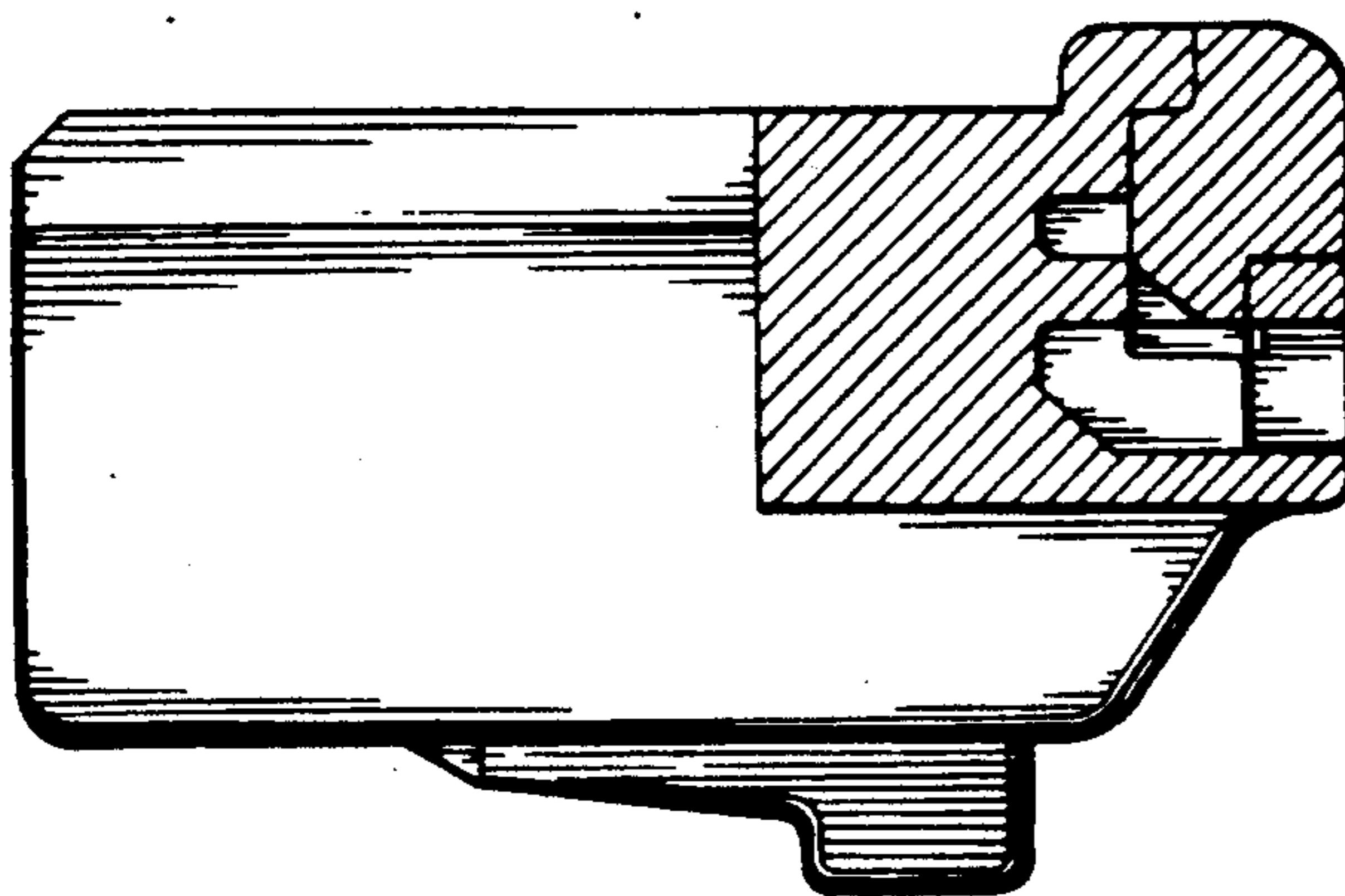




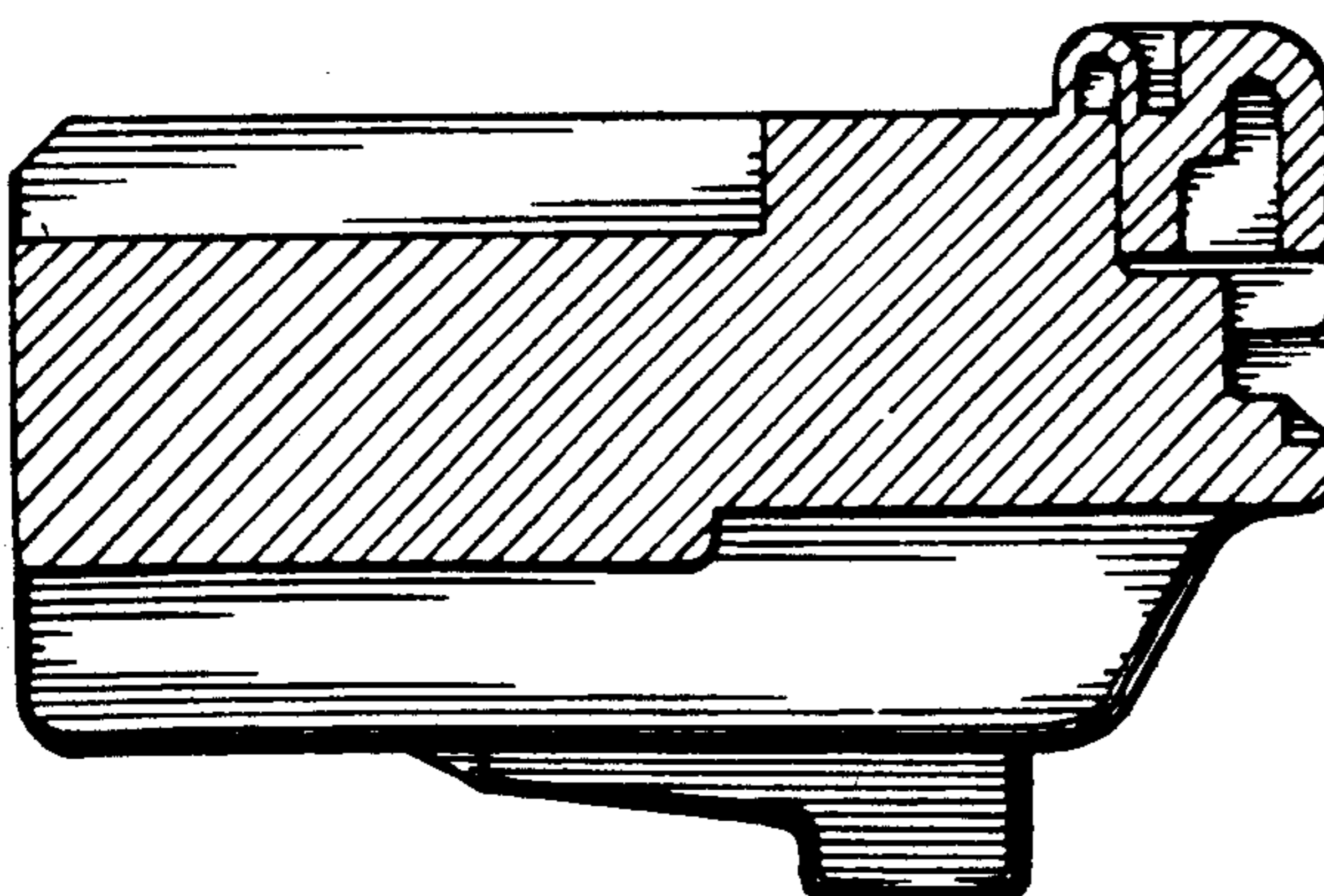
**FIG 14**



**FIG 15**



**FIG 16**



**FIG 17**