

[54] **TOY SHARK**

[75] **Inventor: Janni D. Laursen, Århus N, Denmark**

[73] **Assignee: Interlego A.G., Switzerland**

[\*\*] **Term: 14 Years**

[21] **Appl. No.: 277,912**

[22] **Filed: Nov. 29, 1988**

[52] **U.S. Cl. .... D21/157**

[58] **Field of Search ..... D21/157, 108; 446/97, 446/99, 100, 101, 120, 128**

[56] **References Cited**

**U.S. PATENT DOCUMENTS**

- D. 195,778 7/1963 White ..... D21/157
- D. 205,457 8/1966 Bronte .

*Primary Examiner*—Melvin B. Feifer  
*Attorney, Agent, or Firm*—Kane, Dalsimer, Sullivan, Kurucz, Levy, Eisele and Richard

[57] **CLAIM**

The ornamental design for a toy shark, as shown and described.

**DESCRIPTION**

FIG. 1 is a top perspective view of a toy shark showing my new design;  
FIG. 2 is a bottom perspective view thereof;  
FIG. 3 is a front elevational view thereof;  
FIG. 4 is a rear elevational view thereof;  
FIG. 5 is a top plan view thereof;  
FIG. 6 is a bottom plan view thereof;  
FIG. 7 is a side elevational view thereof, the side opposite being identical, and  
FIG. 8 is a side elevational view of the toy shark with open jaws, the side opposite being identical.

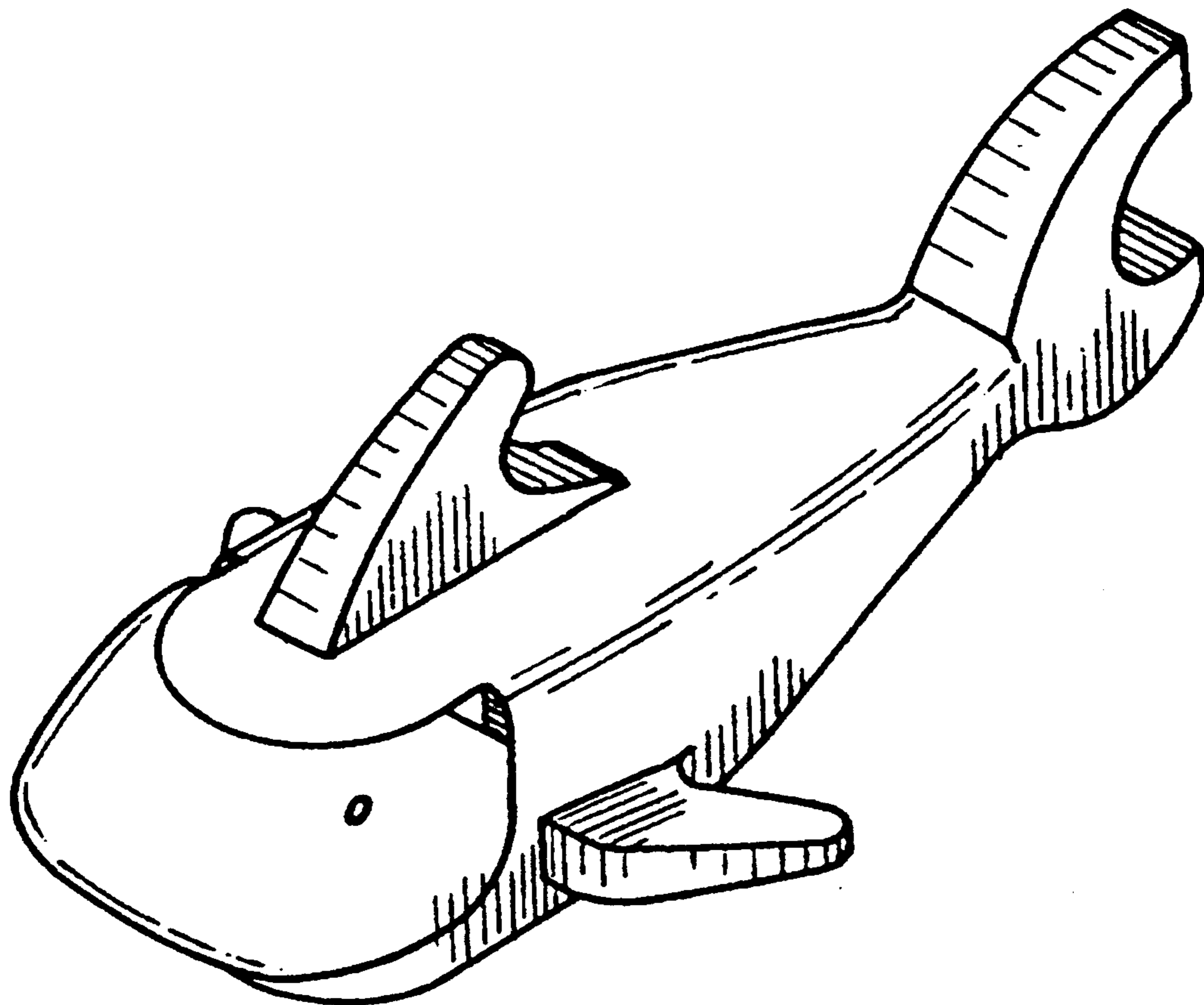

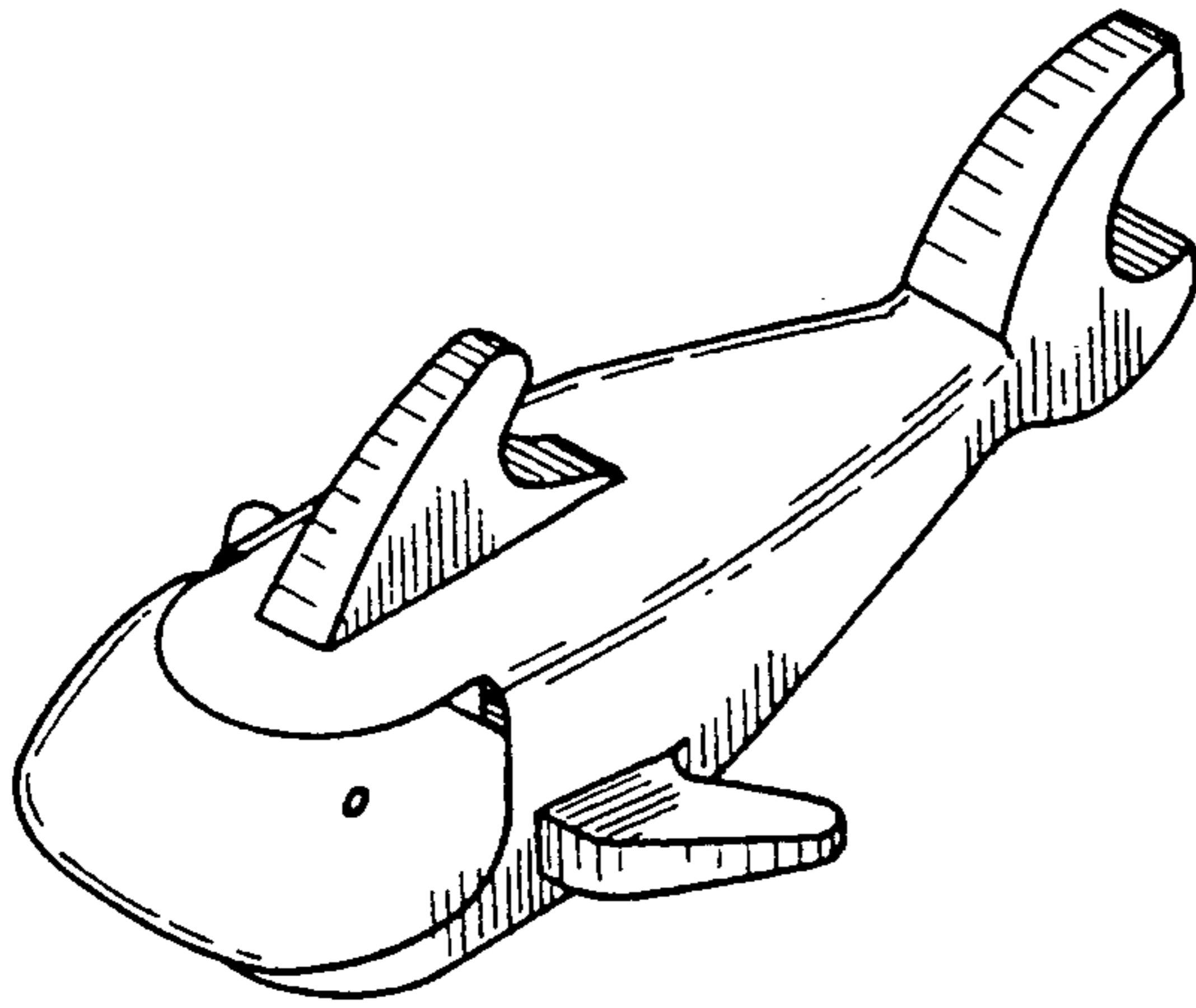

FIG.1

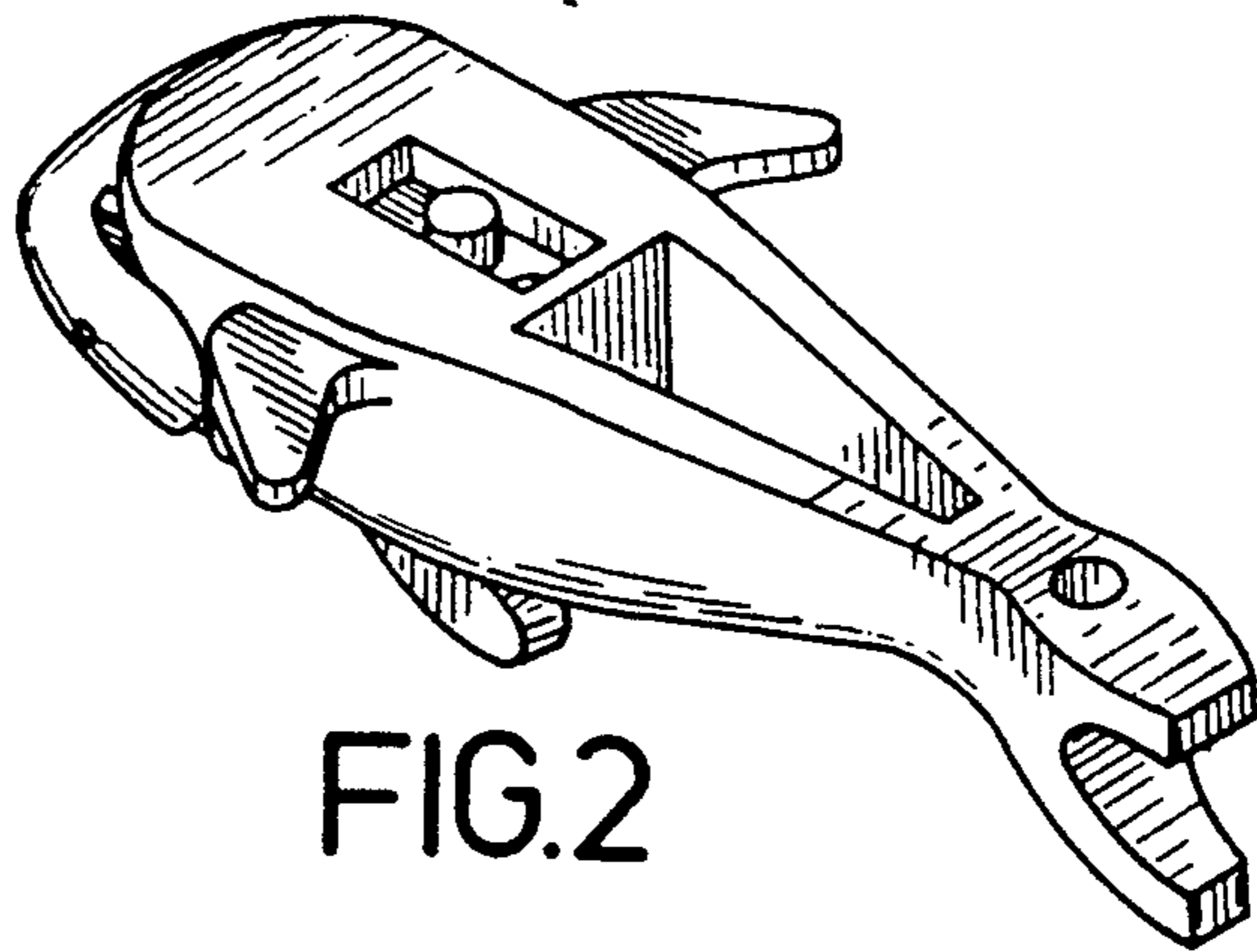

FIG.2

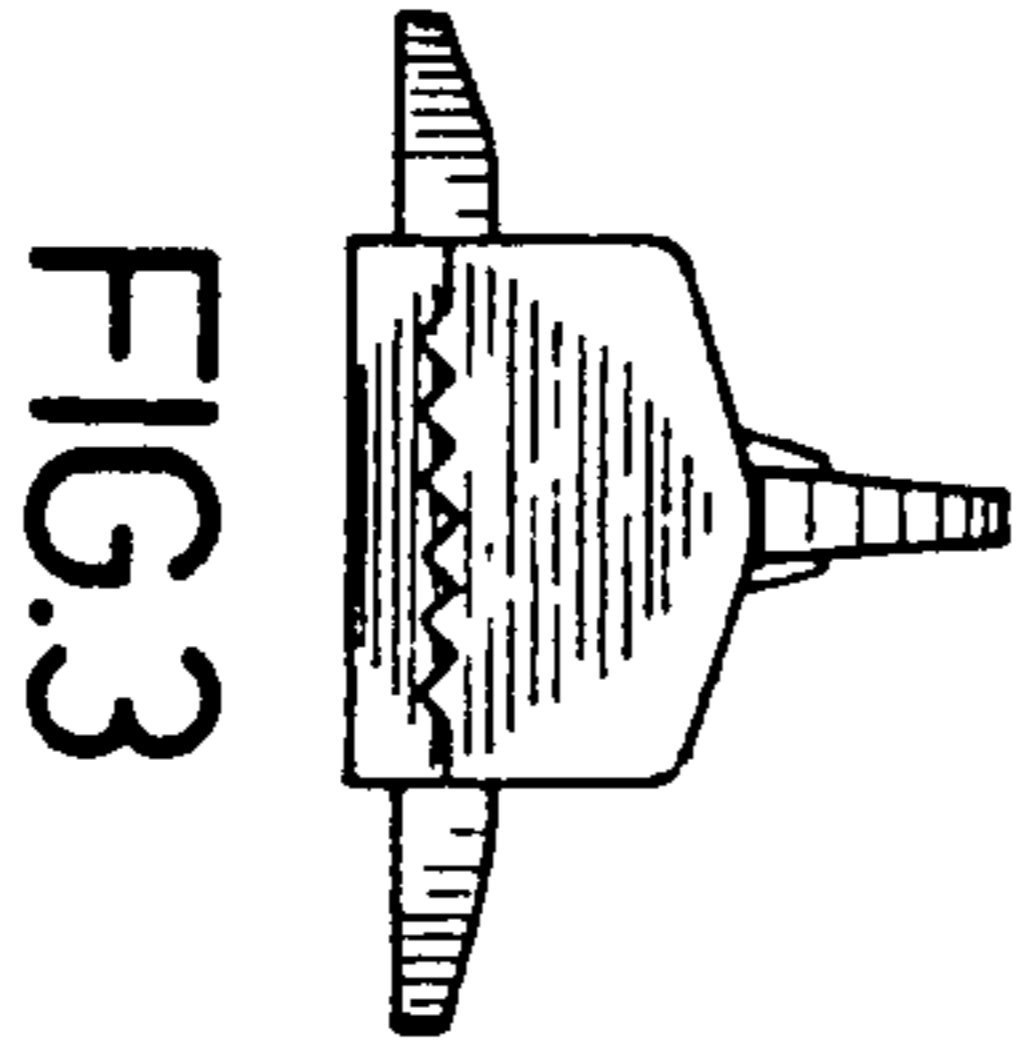

FIG.3

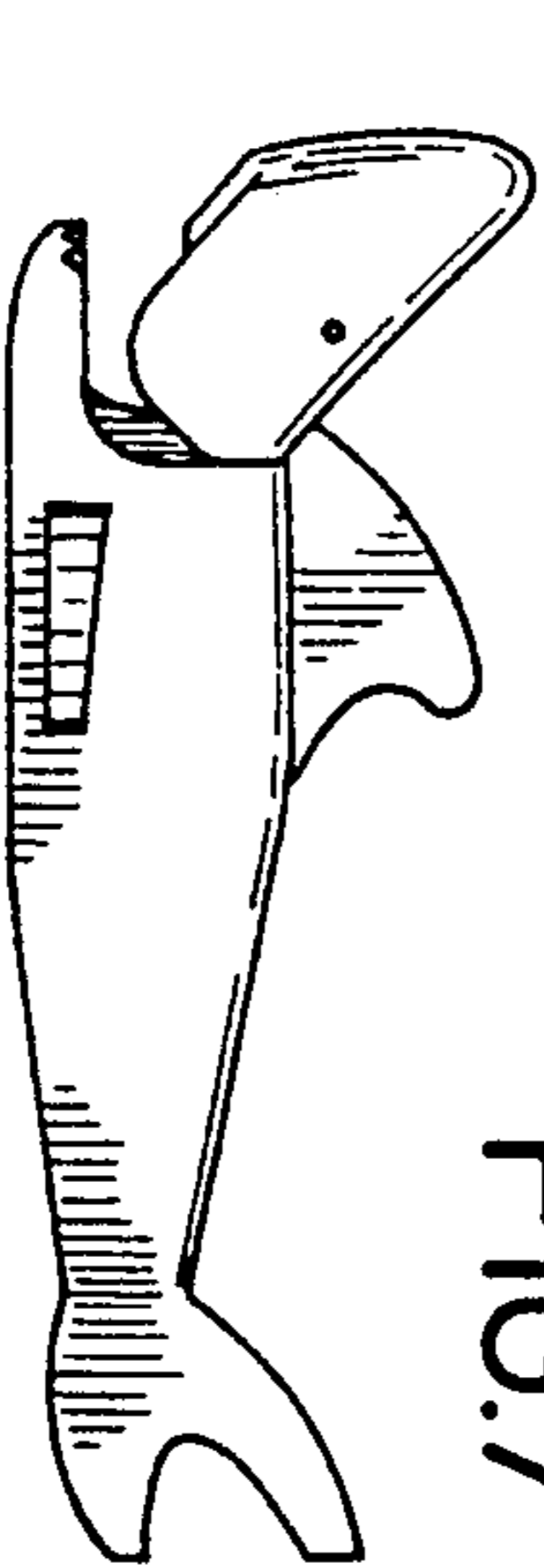

FIG.8

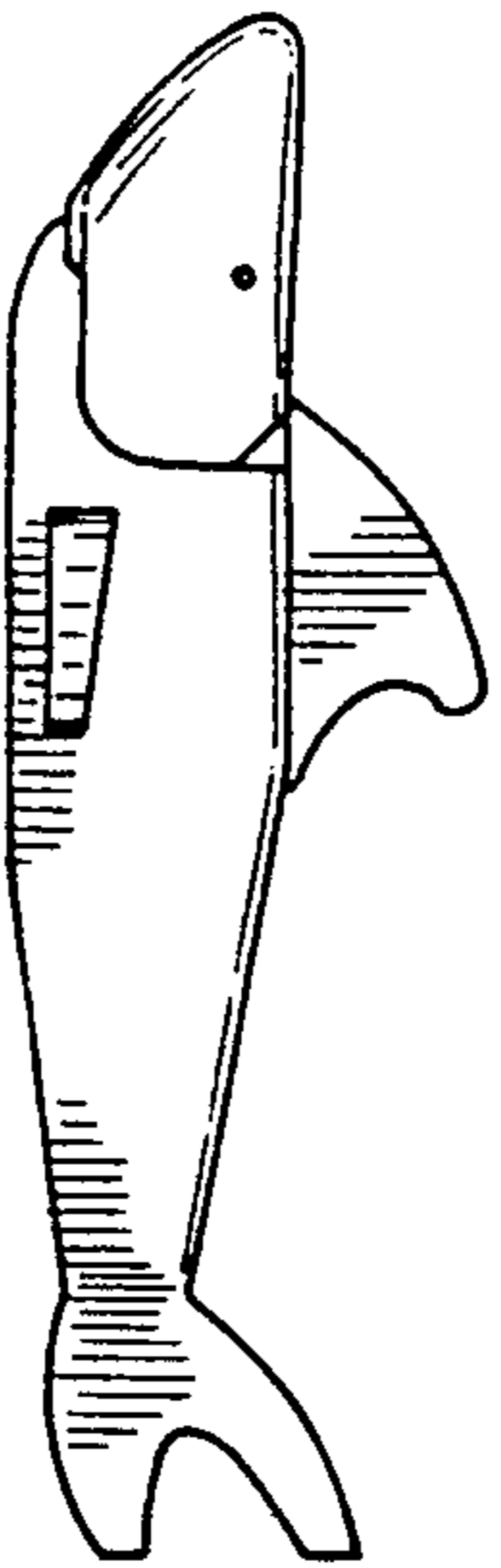

FIG.7

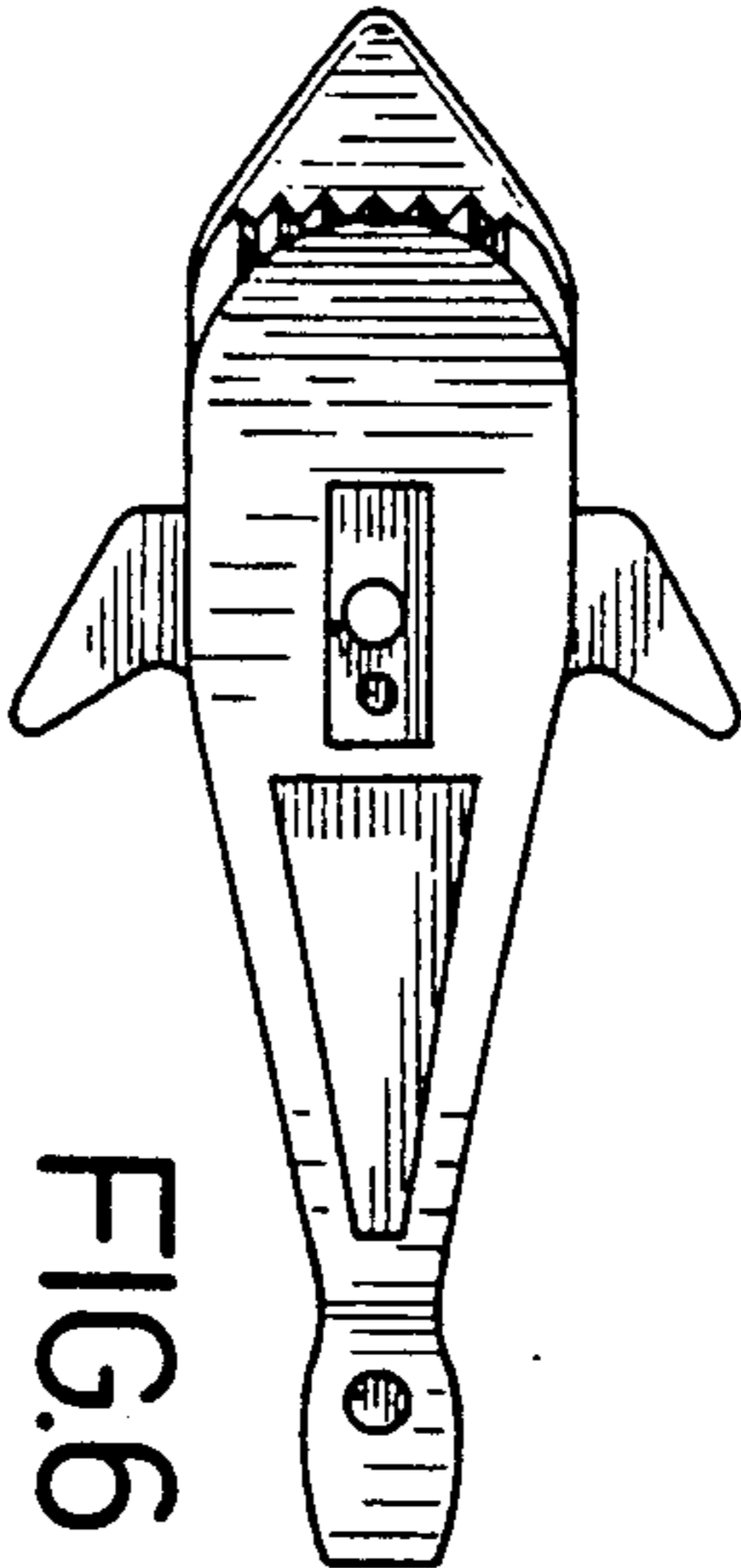

FIG.6

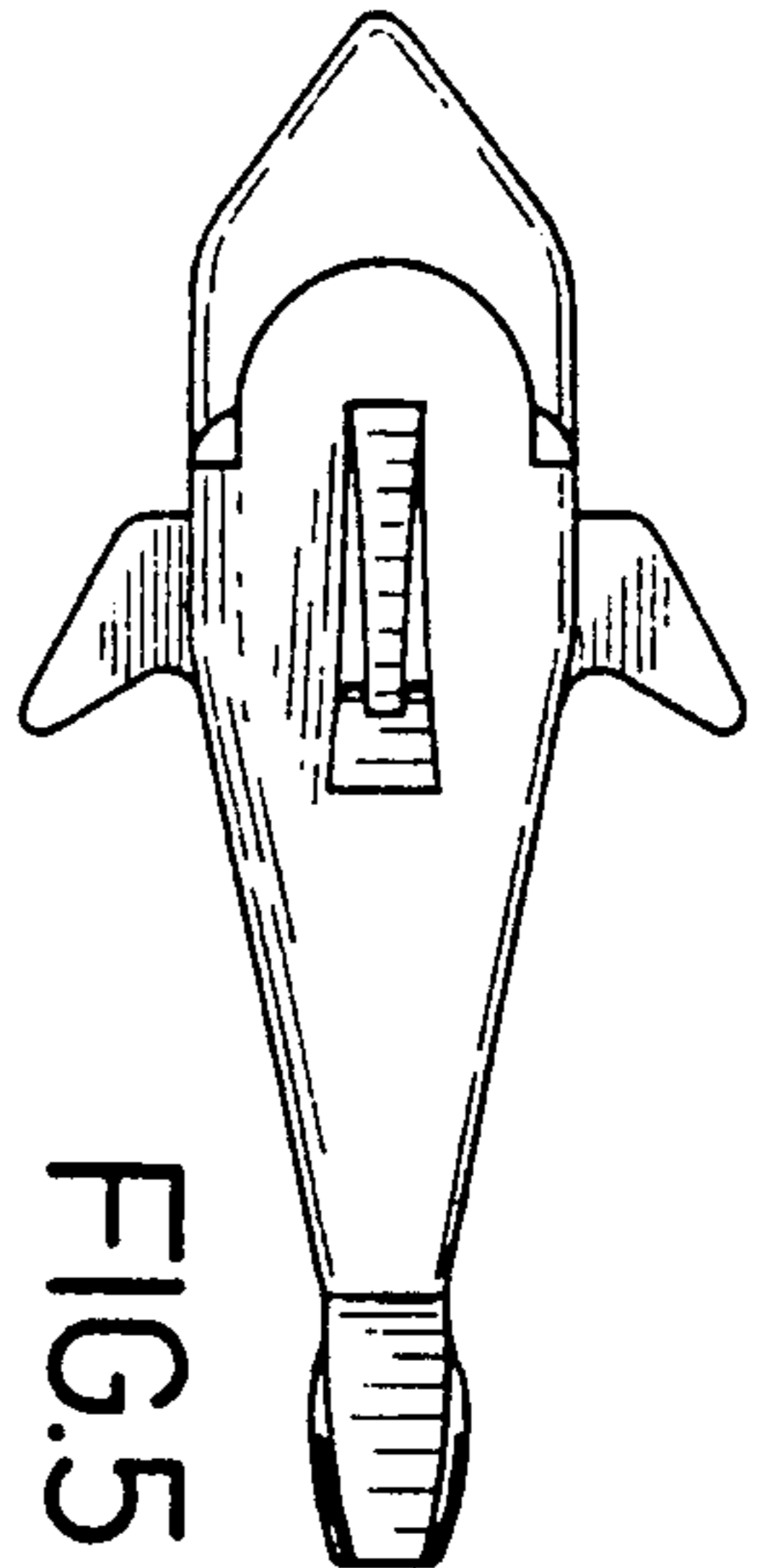

FIG.5

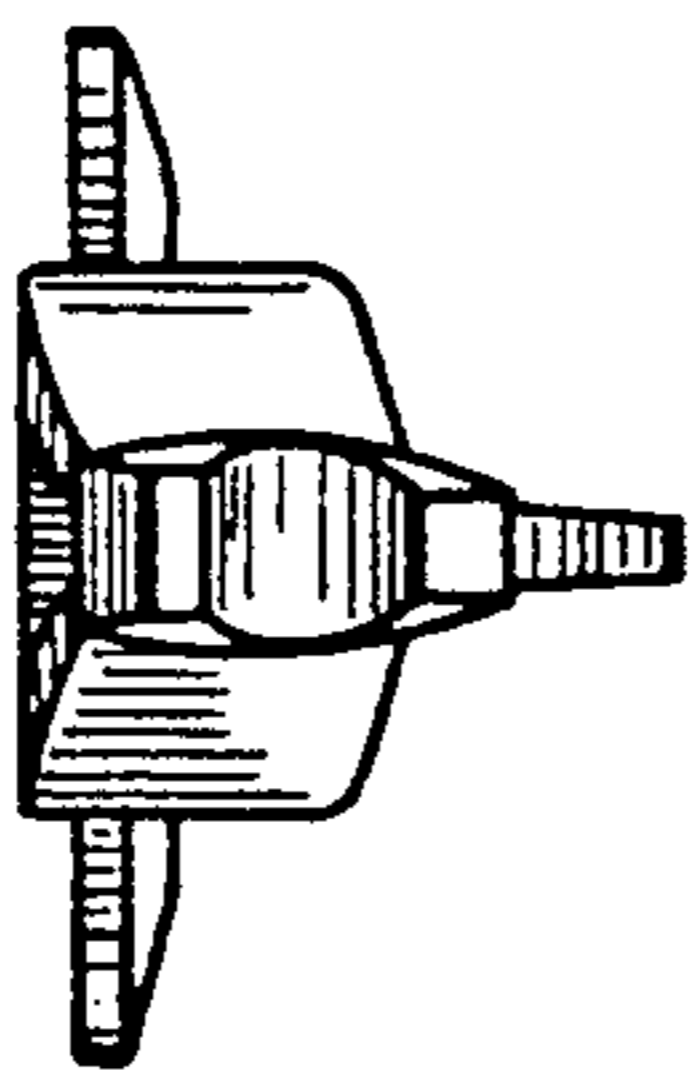

FIG.4