

[54] CAMERA

[75] Inventors: Makoto Isozaki; Eiichi Okamoto, both of Tokyo, Japan

[73] Assignee: Fuji Photo Film Co., Ltd., Kanagawa, Japan

[**] Term: 14 Years

[21] Appl. No.: 277,851

[22] Filed: Nov. 30, 1988

[30] Foreign Application Priority Data

- May 30, 1988 [JP] Japan 63-21264
- May 30, 1988 [JP] Japan 63-21265
- [52] U.S. Cl. D16/209
- [58] Field of Search D16/200, 201, 203, 204, D16/209, 217, 218; 354/126, 127.11, 149.1, 202, 288

[56] References Cited

U.S. PATENT DOCUMENTS

- D. 290,464 6/1987 Kato D16/209
- D. 295,756 5/1988 Ando et al. D16/209
- D. 296,333 6/1988 Inoue D16/209
- D. 296,703 7/1988 Goto et al. D16/209
- D. 306,370 2/1990 Suyama et al. D16/209
- D. 306,453 3/1990 Tanaka et al. D16/209
- D. 311,016 10/1990 Tanaka et al. D16/209

OTHER PUBLICATIONS

Best Catalog, 1987, p. 268, Cameras.

Best Catalog, 1987, p. 267, Cameras.

W. Bell Catalog, 1987, p. 274, Cameras.

Primary Examiner—Melvin B. Feifer

Assistant Examiner—Philip Hyder

Attorney, Agent, or Firm—Young & Thompson

[57] CLAIM

The ornamental design for a camera, as shown and described.

DESCRIPTION

FIG. 1 is a front, side and top perspective view of a first embodiment of a camera showing our new design; FIG. 2 is a rear, top and side perspective view thereof; FIG. 3 is a front elevational view thereof; FIG. 4 is a rear elevational view thereof; FIG. 5 is a top plan view thereof; FIG. 6 is a bottom plan view thereof; FIG. 7 is an end elevational view thereof from the left of FIG. 3; FIG. 8 is an end elevational view thereof from the right of FIG. 3; and FIG. 9 is a front, side and top perspective view of a second embodiment thereof; FIG. 10 is a rear, top and side perspective view of FIG. 9; FIG. 11 is a front elevational view of FIG. 9; FIG. 12 is a rear elevational view of FIG. 9; FIG. 13 is a top plan view of FIG. 9; FIG. 14 is a bottom plan view of FIG. 9; FIG. 15 is a left side elevational view of FIG. 11; and FIG. 16 is a right side elevational view of FIG. 11.

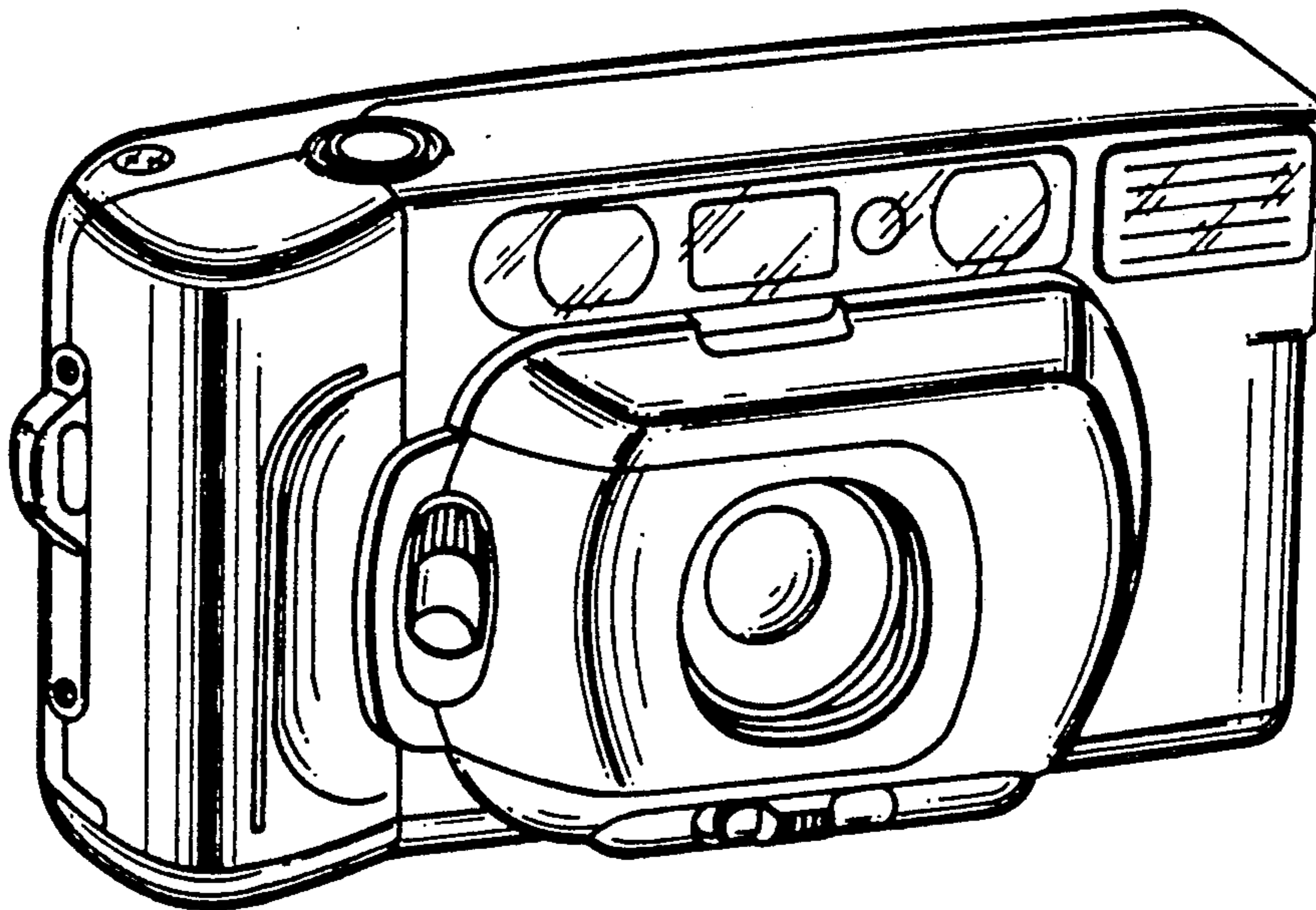

FIG. 1

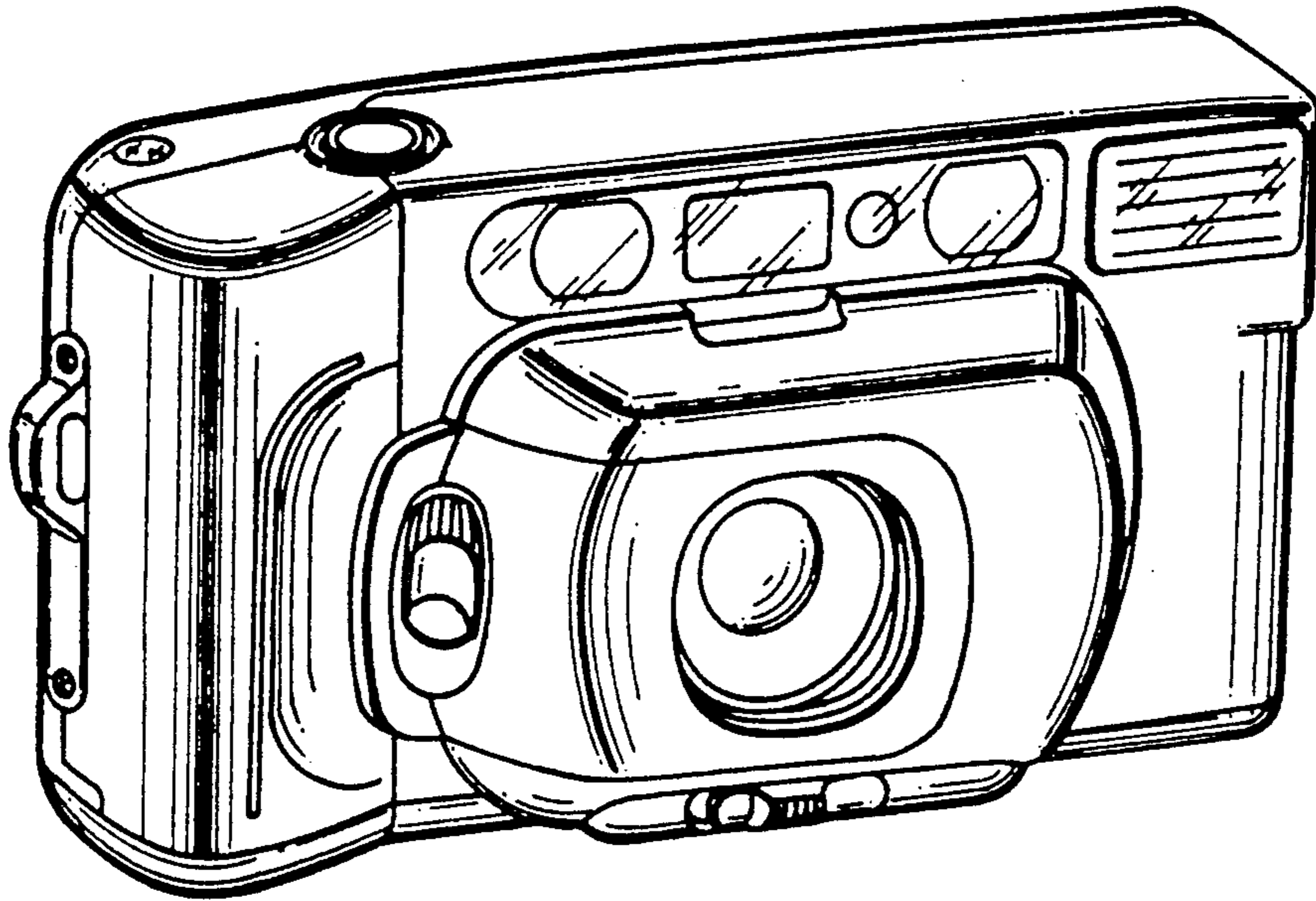

FIG. 2

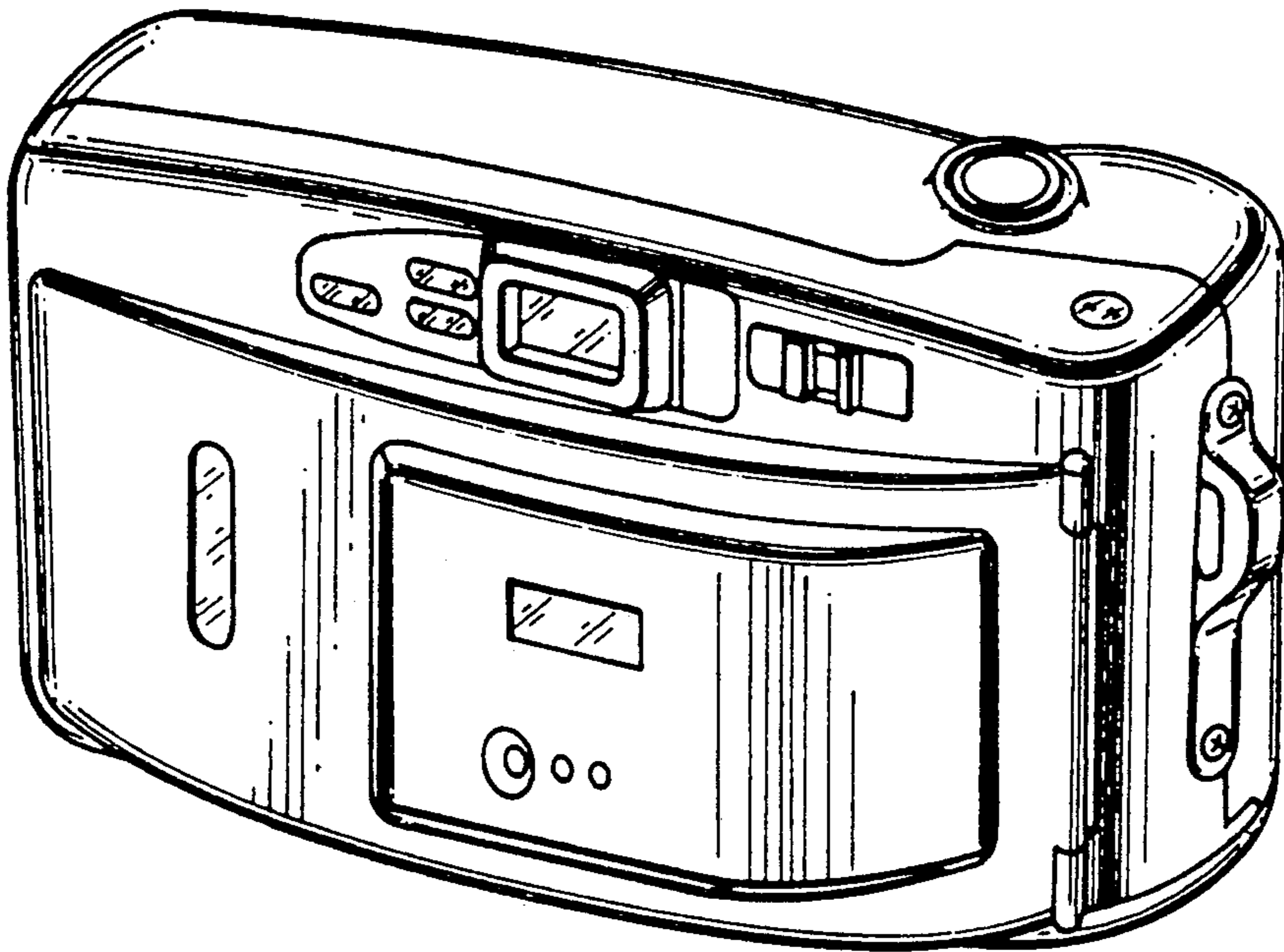

FIG. 3

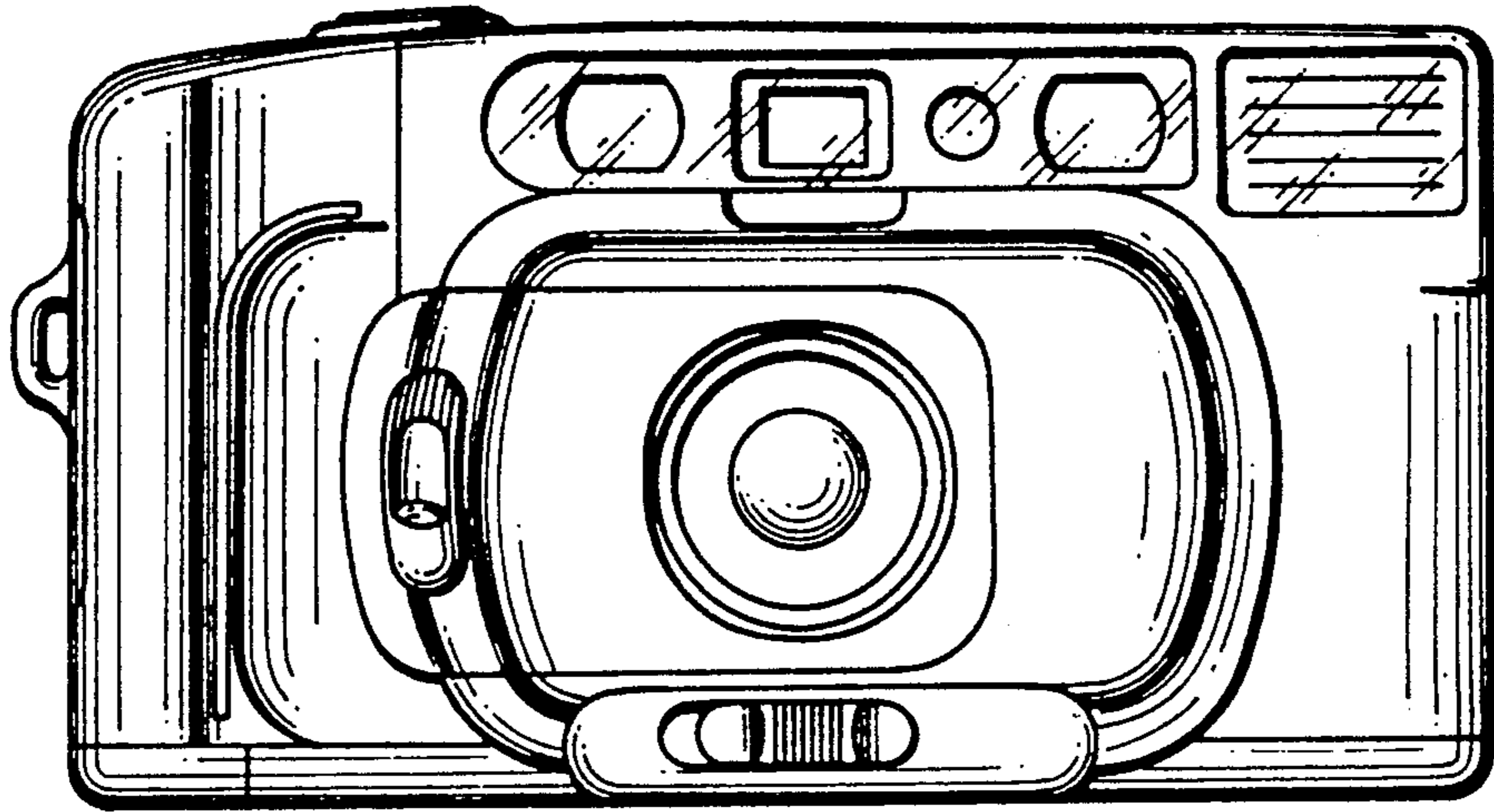

FIG. 4

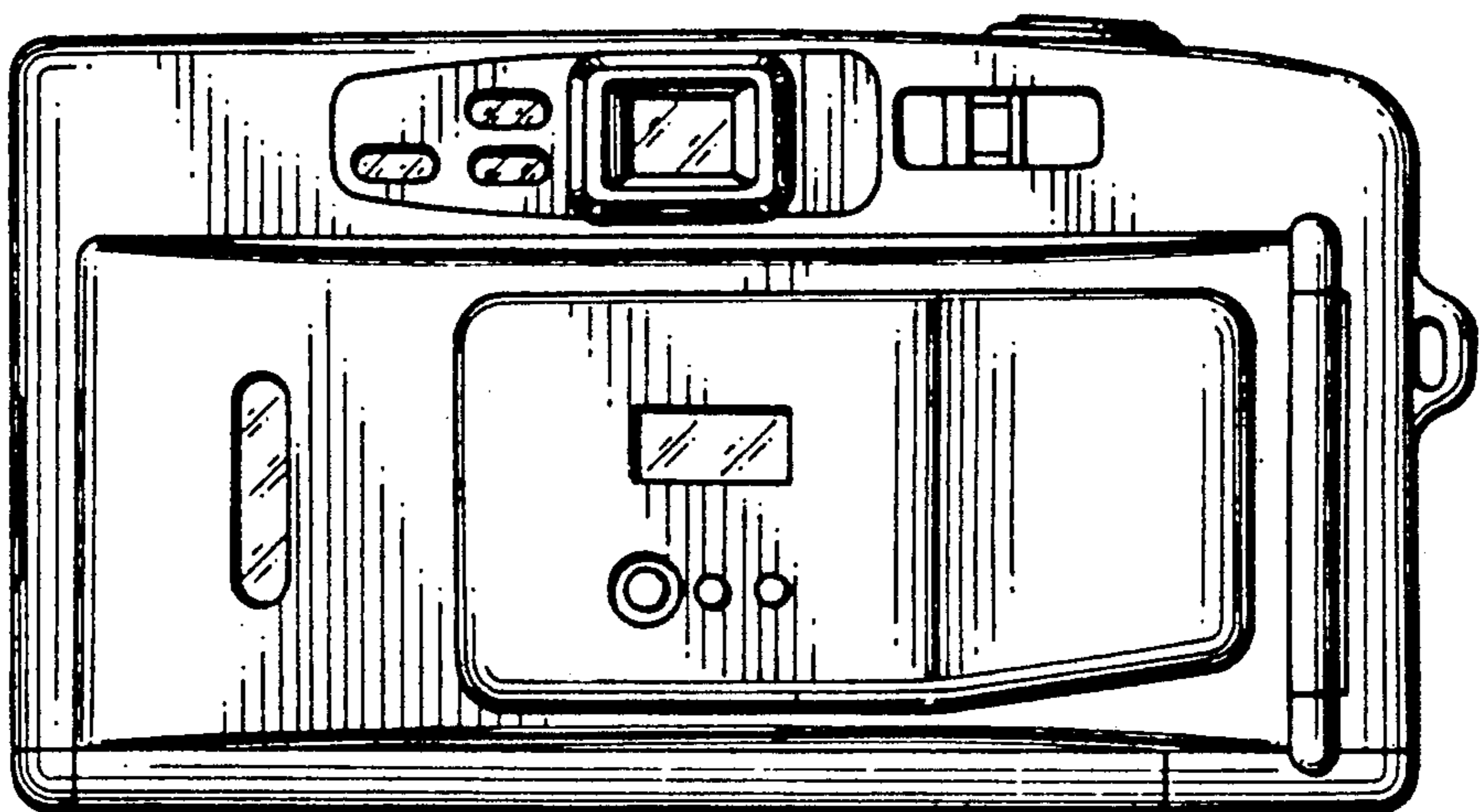

FIG. 5

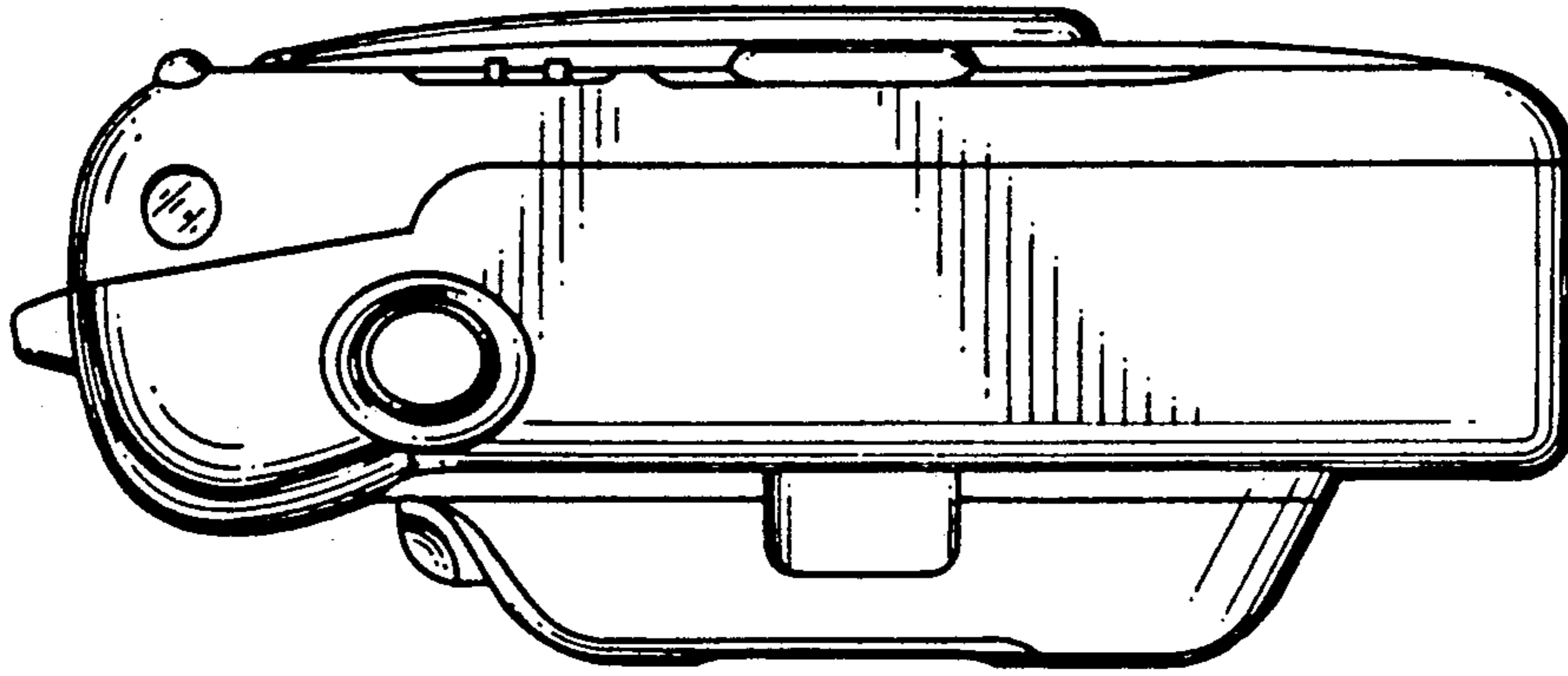

FIG. 6

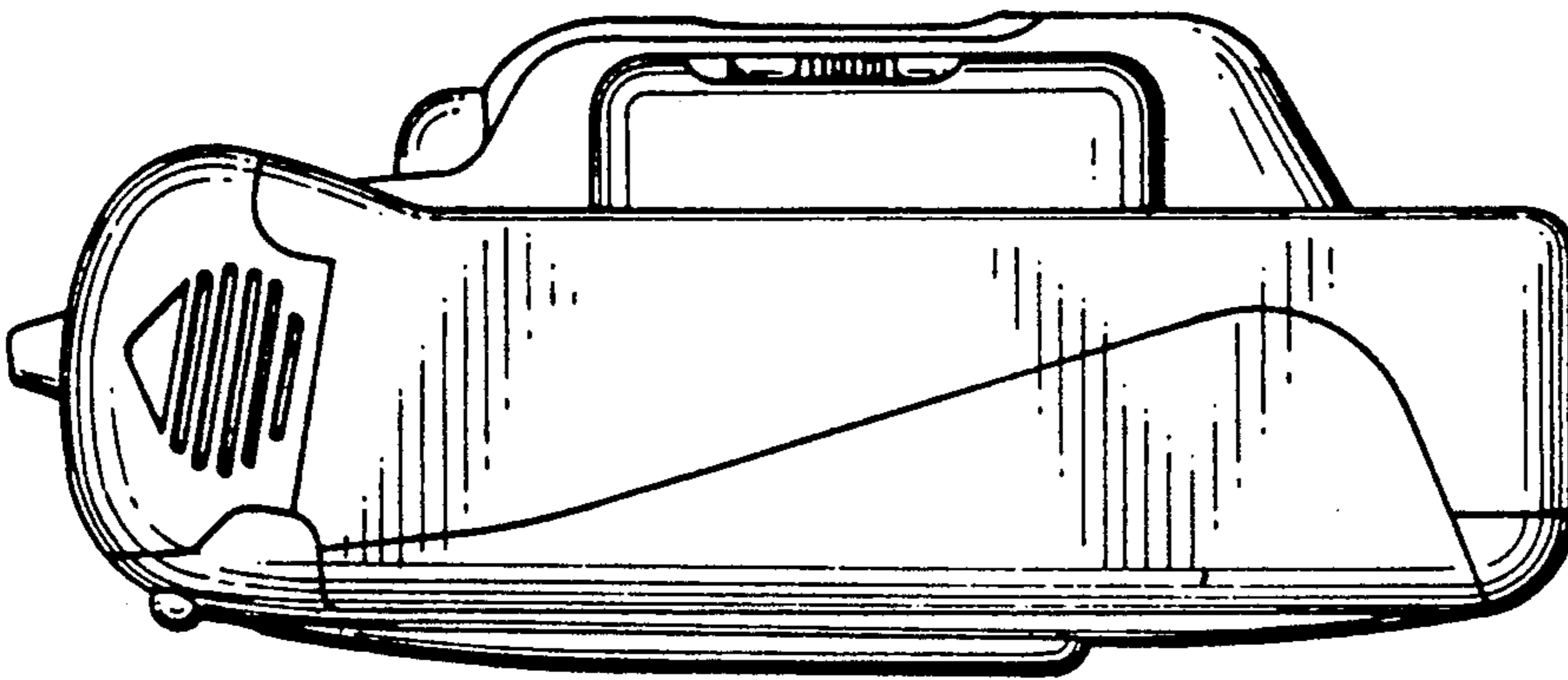

FIG. 7

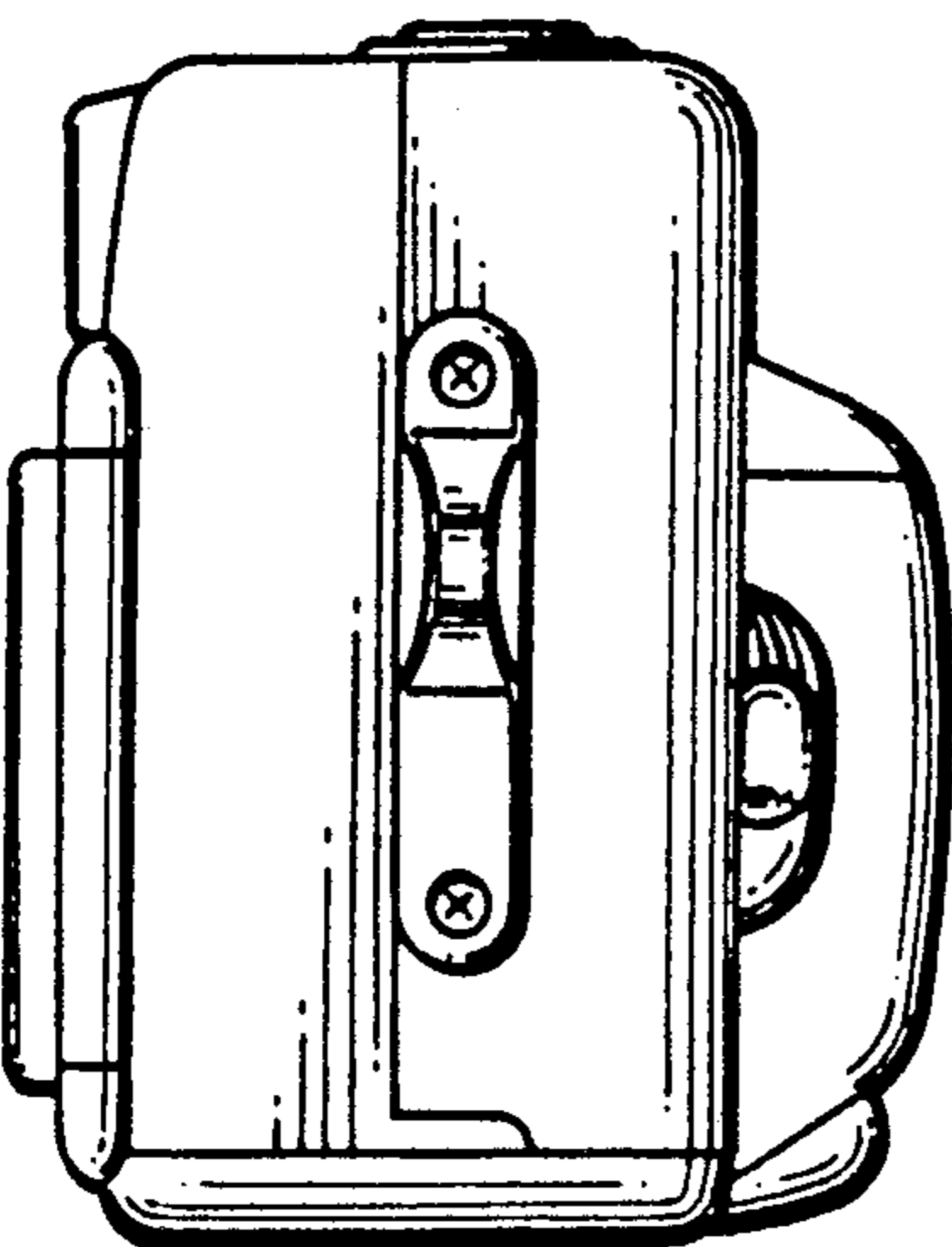

FIG. 8

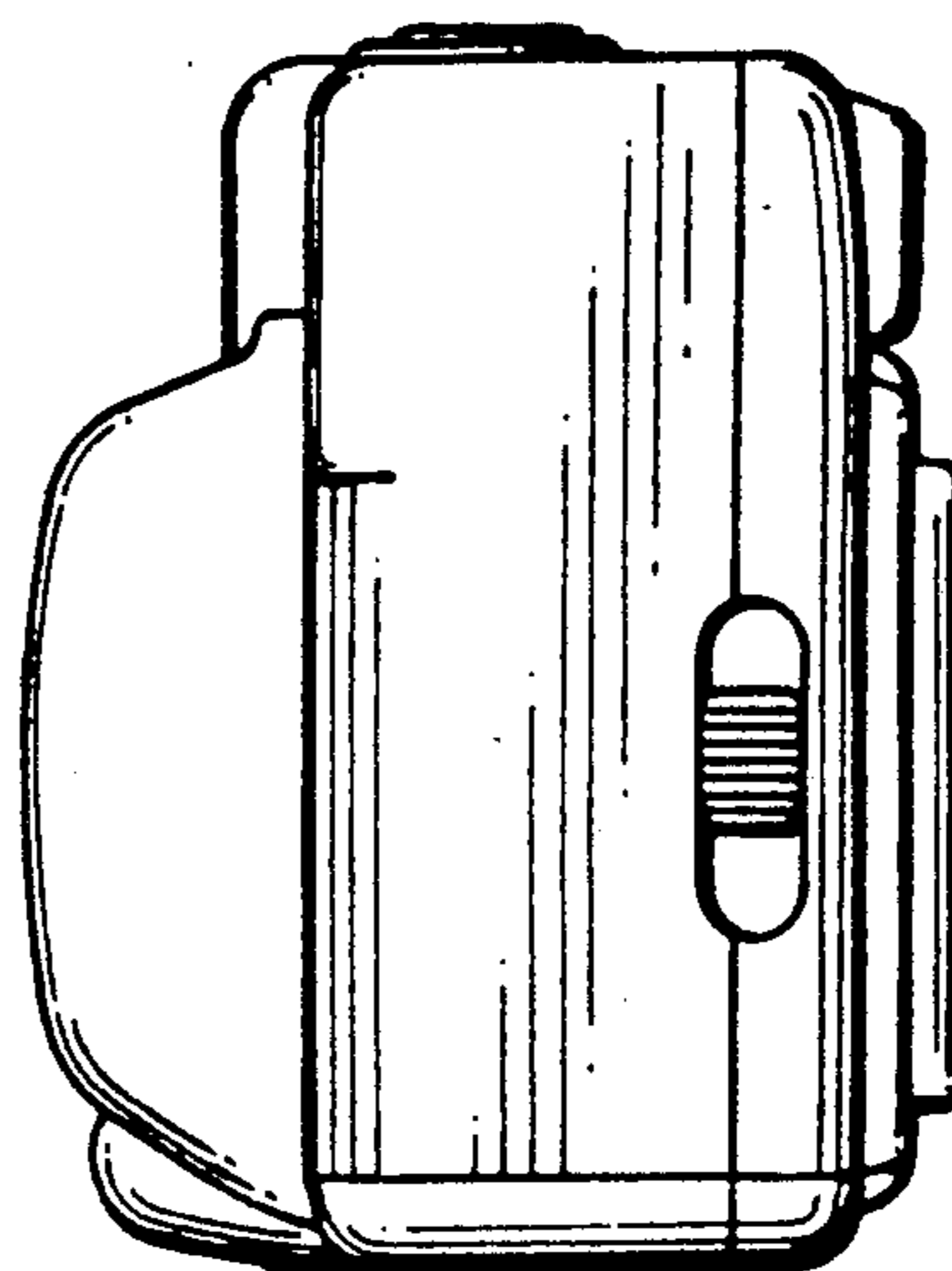

FIG. 9

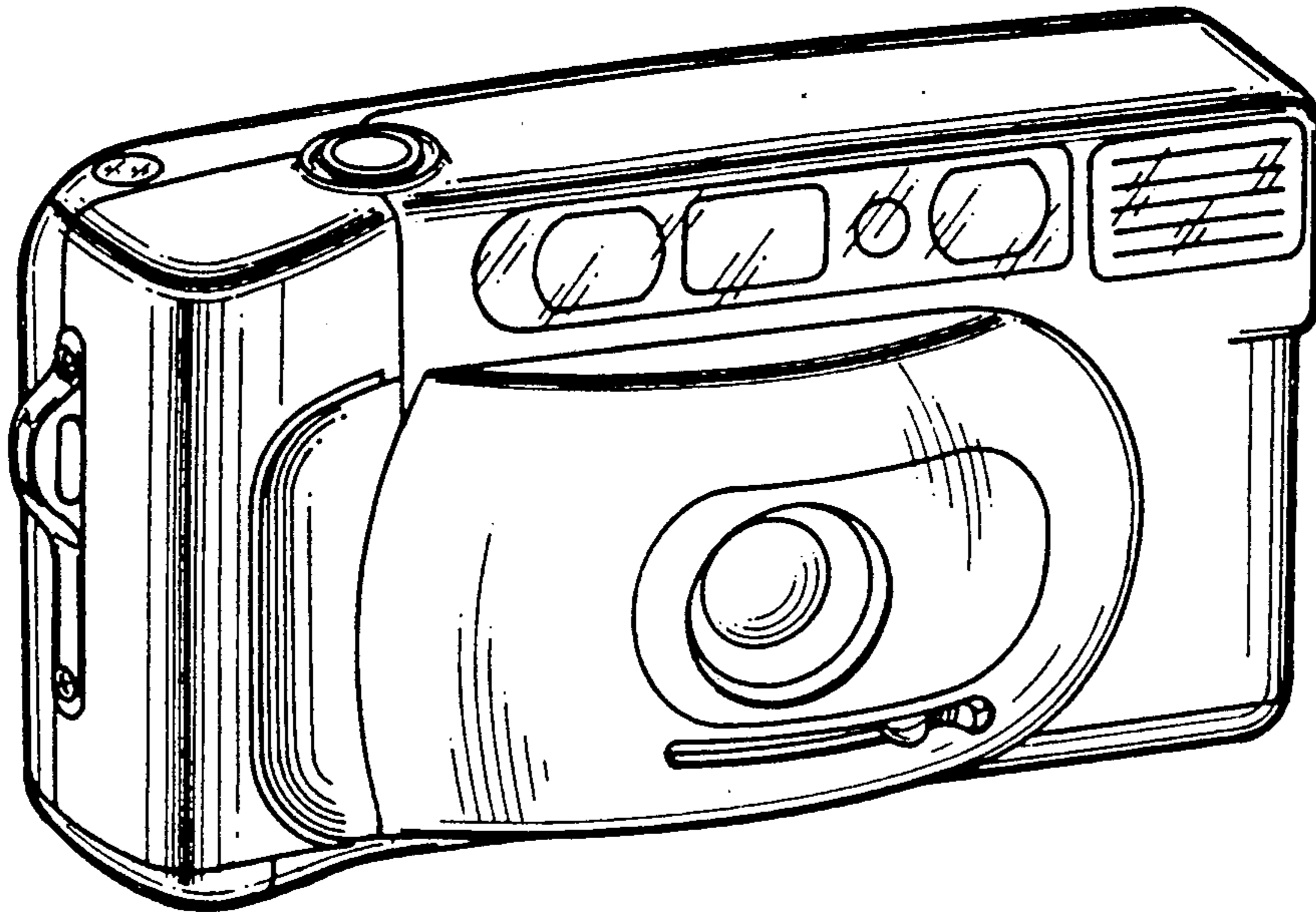

FIG. 10

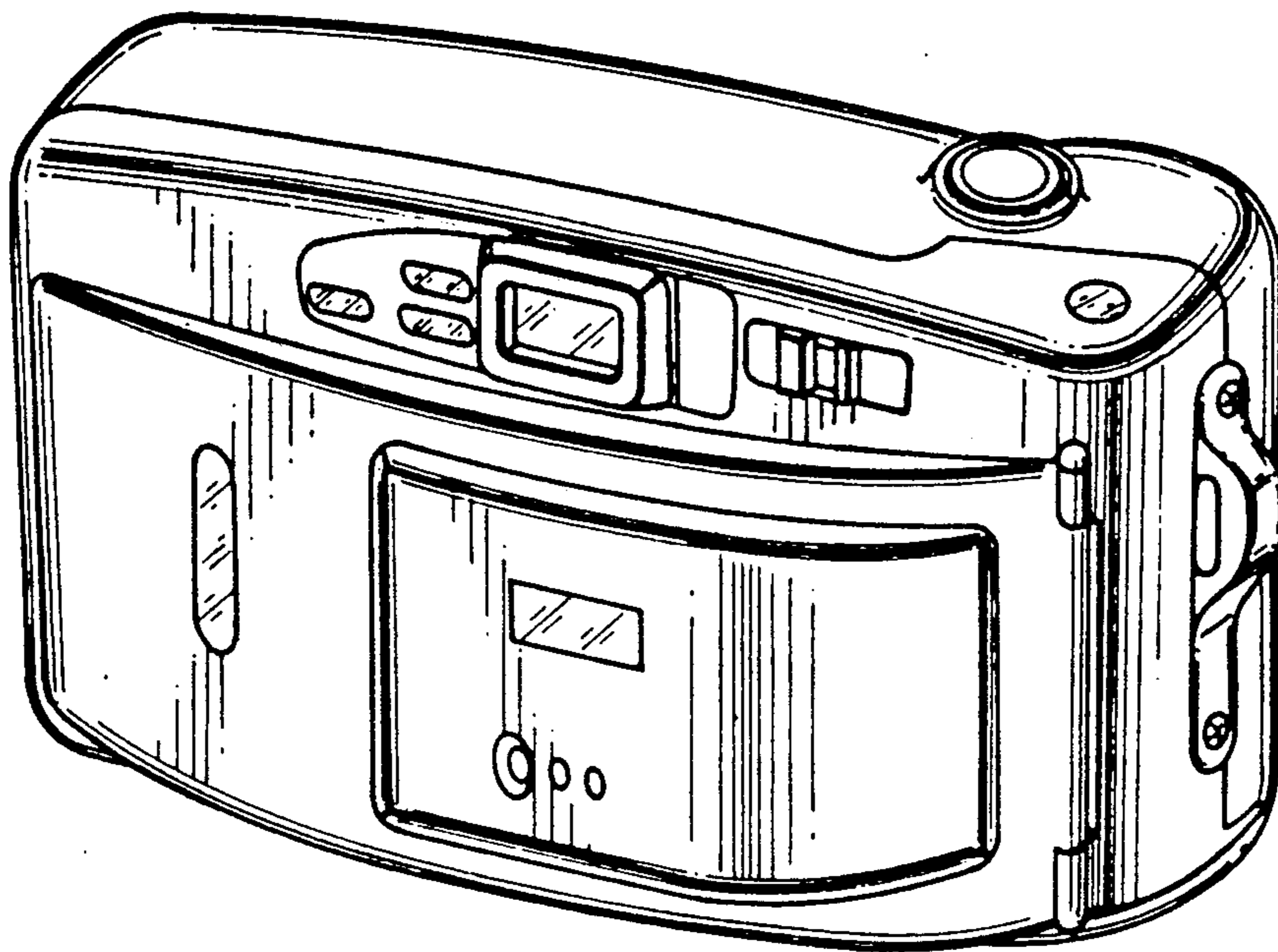

FIG. 11

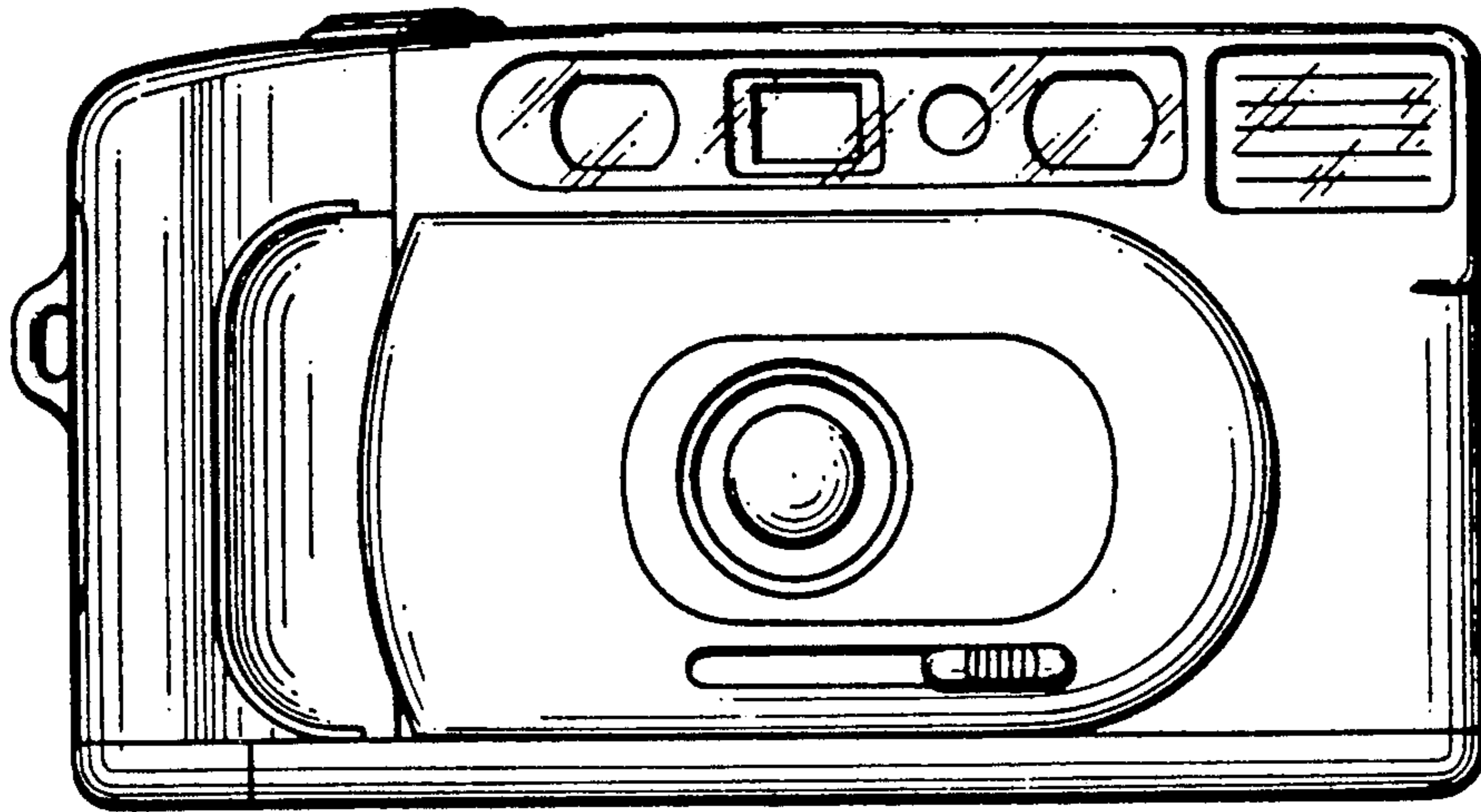

FIG. 12

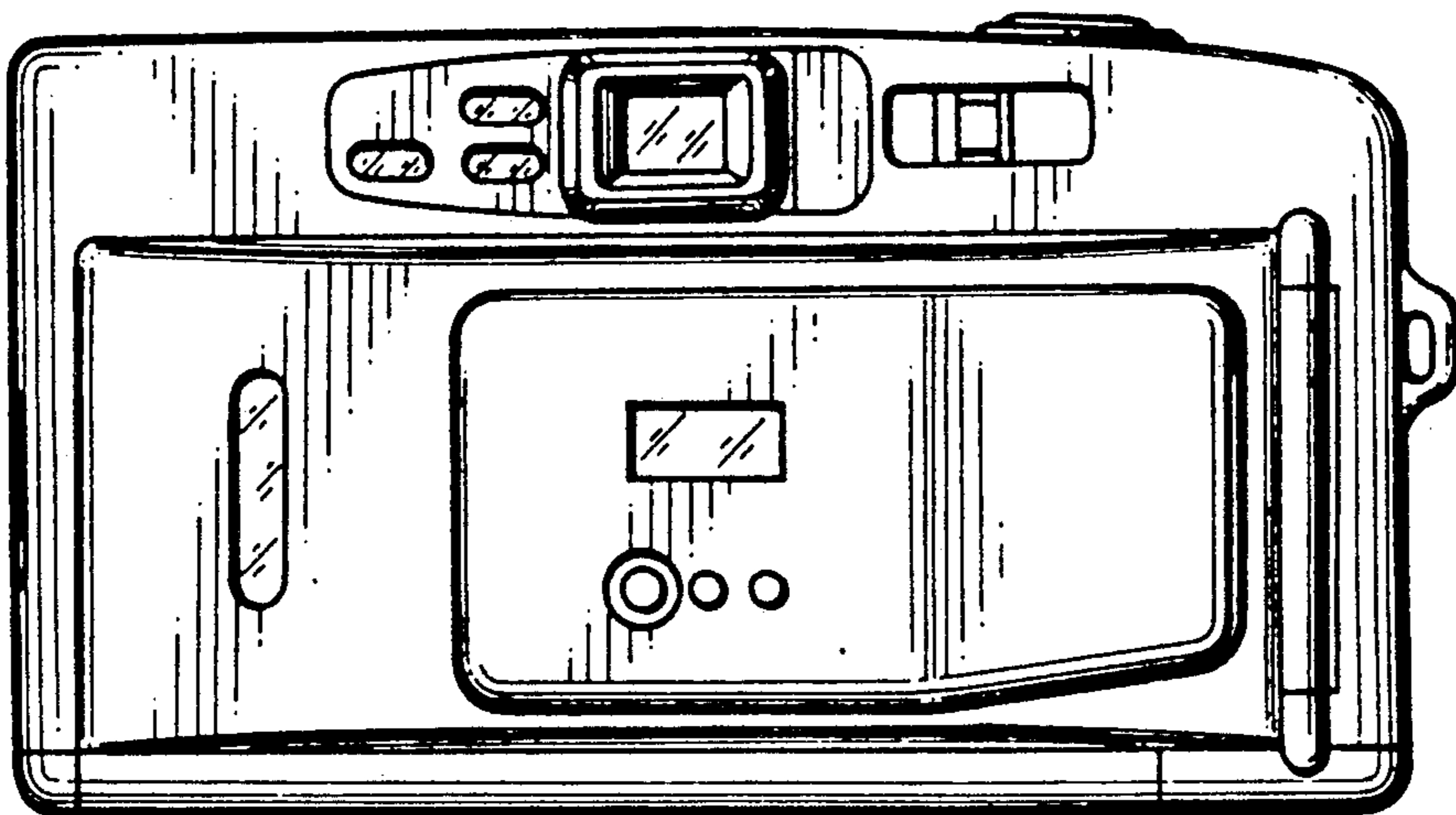

FIG. 13

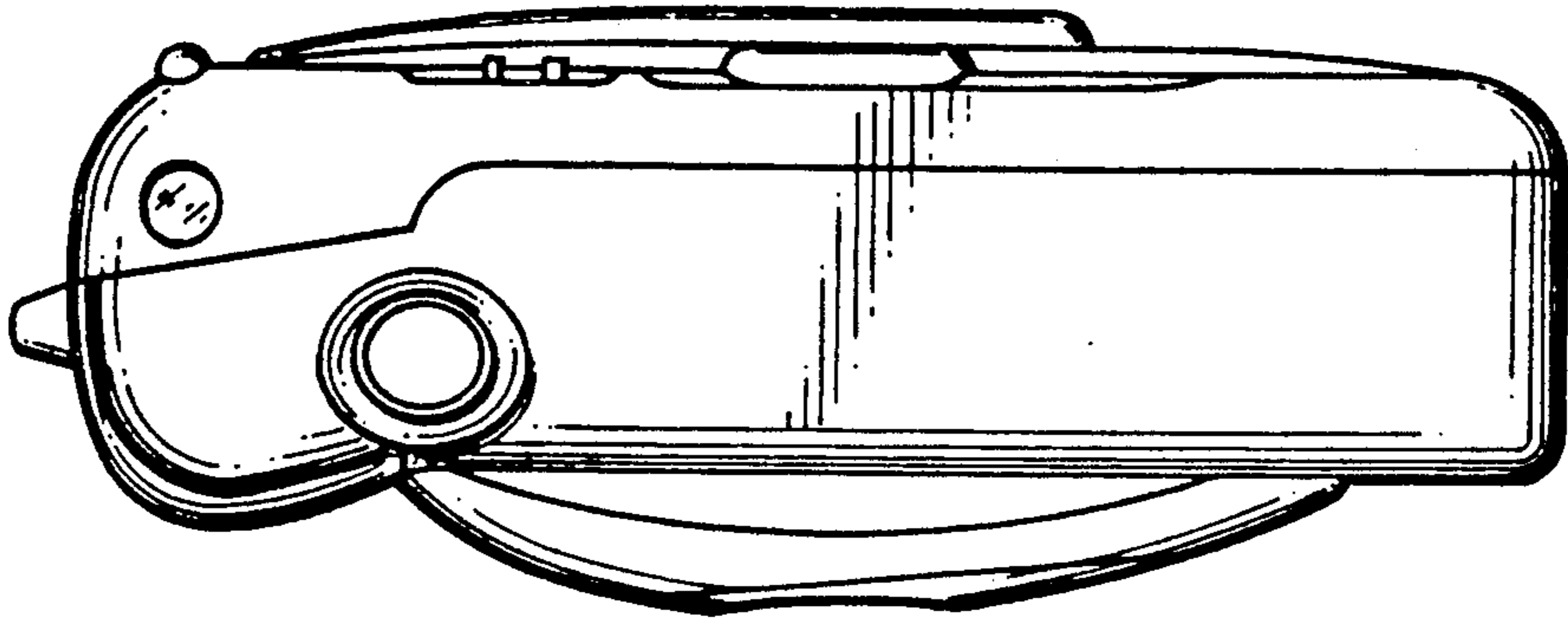

FIG. 14

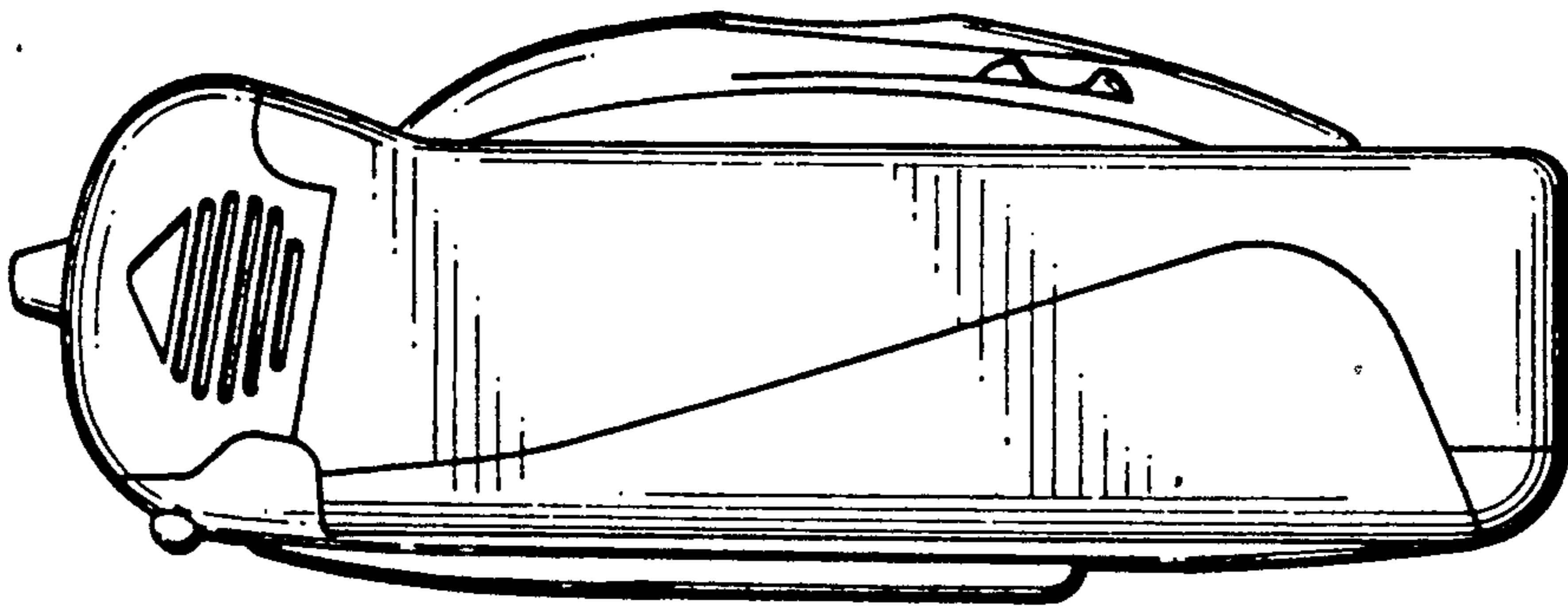

FIG. 15

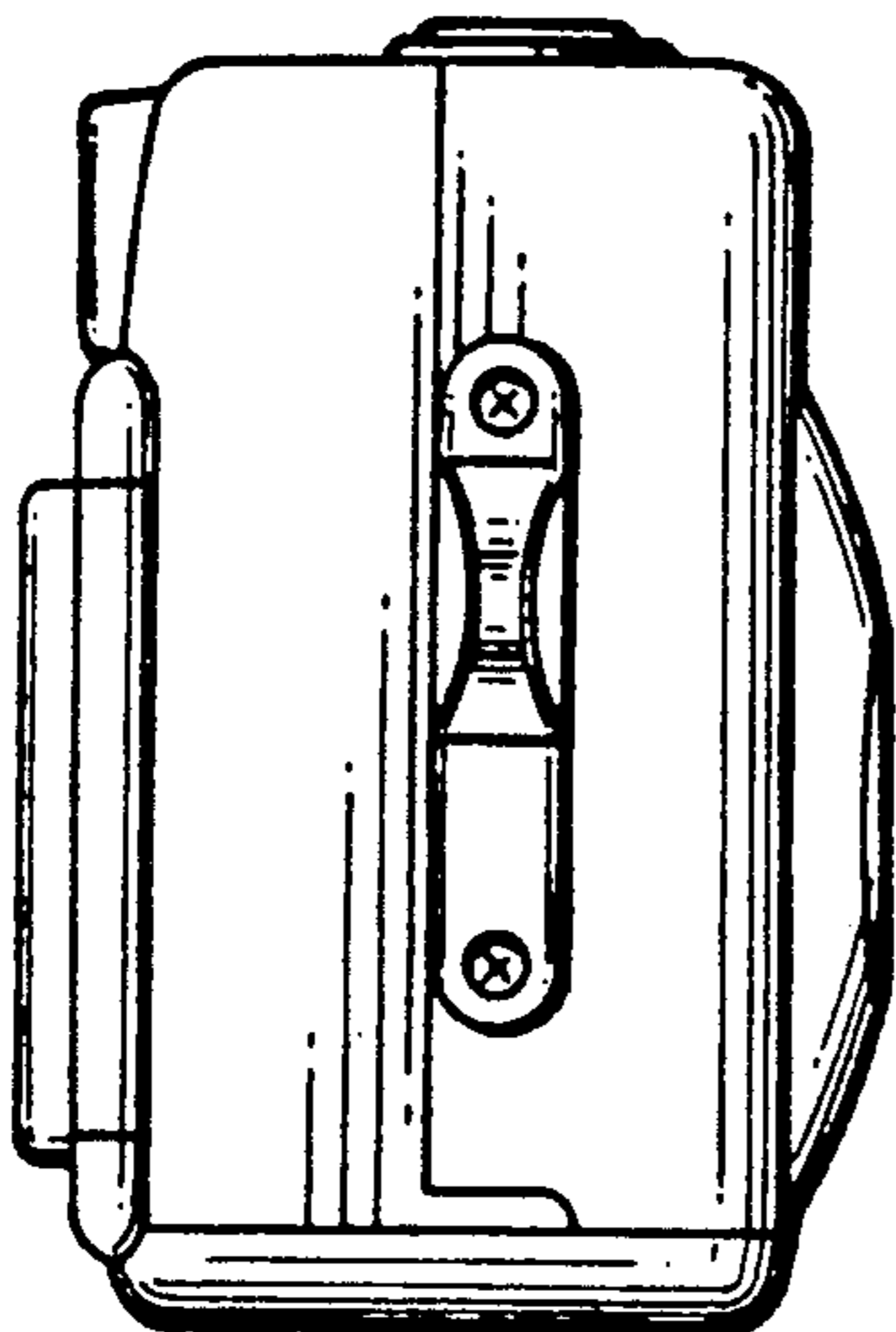

FIG. 16

