

[54] FLOOR TREATING MACHINE

[75] Inventors: Chester W. Bolser, Fremont; Lyle H. Wierenga, Muskegon, both of Mich.

[73] Assignee: Pacific Floor Machine Company, Inc., Grand Haven, Mich.

[\*\*] Term: 14 Years

[21] Appl. No.: 194,723

[22] Filed: May 17, 1988

[52] U.S. Cl. .... D32/19

[58] Field of Search ..... D32/1, 19; D8/62; 15/49 R, 49 C, 50 R, 50 C, 52, 98, 180, 28, 53 R, 53 A, 107, 97 R, 97 B; 51/170 R, 174, 177

[56] References Cited

U.S. PATENT DOCUMENTS

D. 166,572	4/1952	Pond .....	D32/19
D. 178,848	9/1956	Pond .....	D32/19
D. 251,007	2/1979	Burgoon .....	D32/19
D. 282,110	1/1986	Tucker et al. ....	D32/19
D. 296,250	6/1988	Genovese .....	D32/19
D. 296,251	6/1988	Genovese .....	D32/19

4,542,551 9/1985 Phillips ..... 15/49 R

Primary Examiner—A. Hugo Word  
Assistant Examiner—Doris V. Coles  
Attorney, Agent, or Firm—Varnum, Riddering, Schmidt & Howlett

[57] CLAIM

The ornamental design for a floor treating machine, as shown and described.

DESCRIPTION

FIG. 1 is a perspective view of a floor treating machine in the form of a floor cleaner/polisher, showing our new design;  
FIG. 2 is a front elevational view thereof;  
FIG. 3 is a right side elevational view thereof;  
FIG. 4 is a rear elevational view thereof;  
FIG. 5 is a left side elevational view thereof;  
FIG. 6 is a perspective view of a second embodiment of a floor treating machine in the form of a floor scrubber;  
FIG. 7 is a front elevational view thereof;  
FIG. 8 is a right side elevational view thereof;  
FIG. 9 is a rear elevational view thereof; and  
FIG. 10 is a left side elevational view thereof.

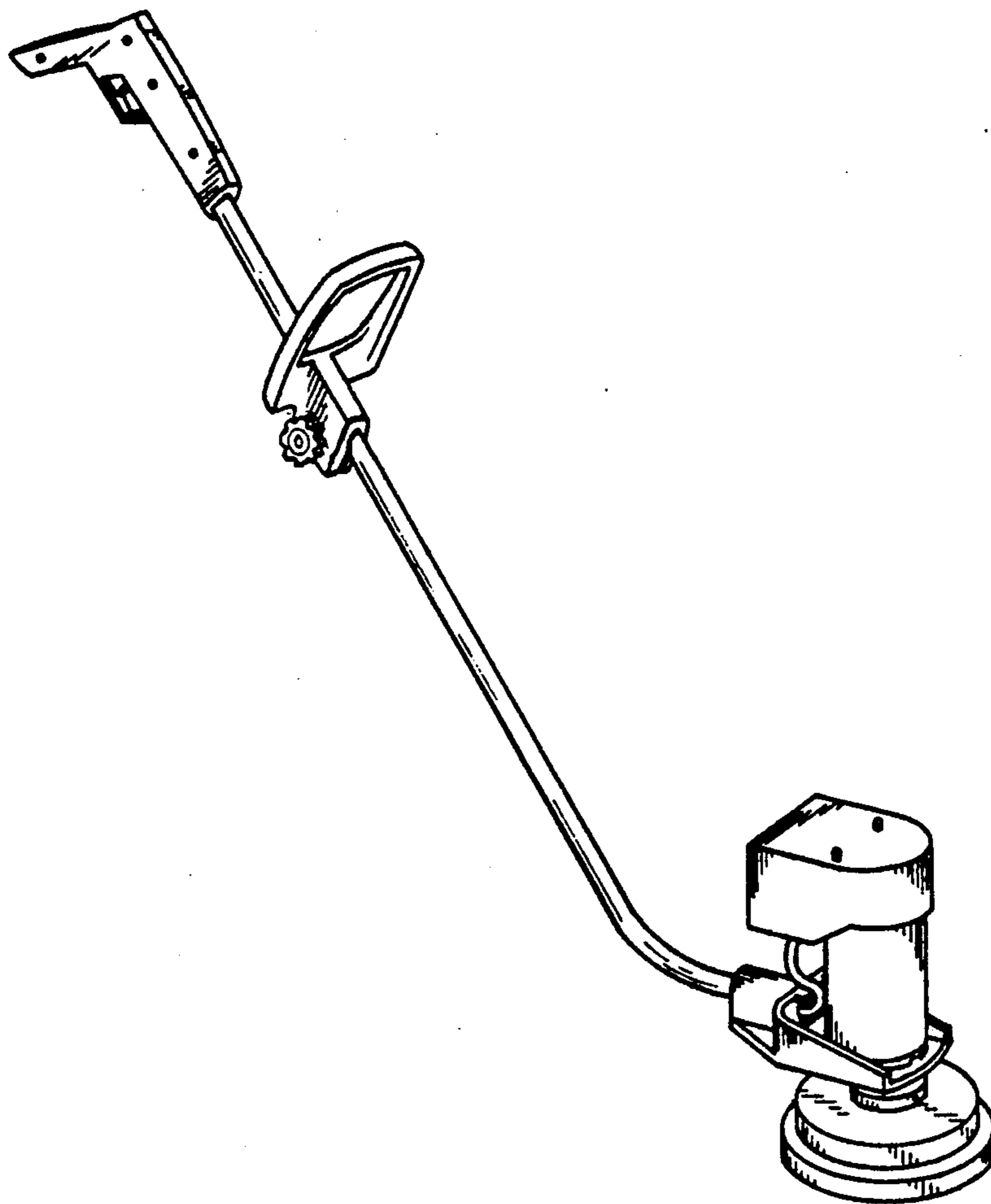

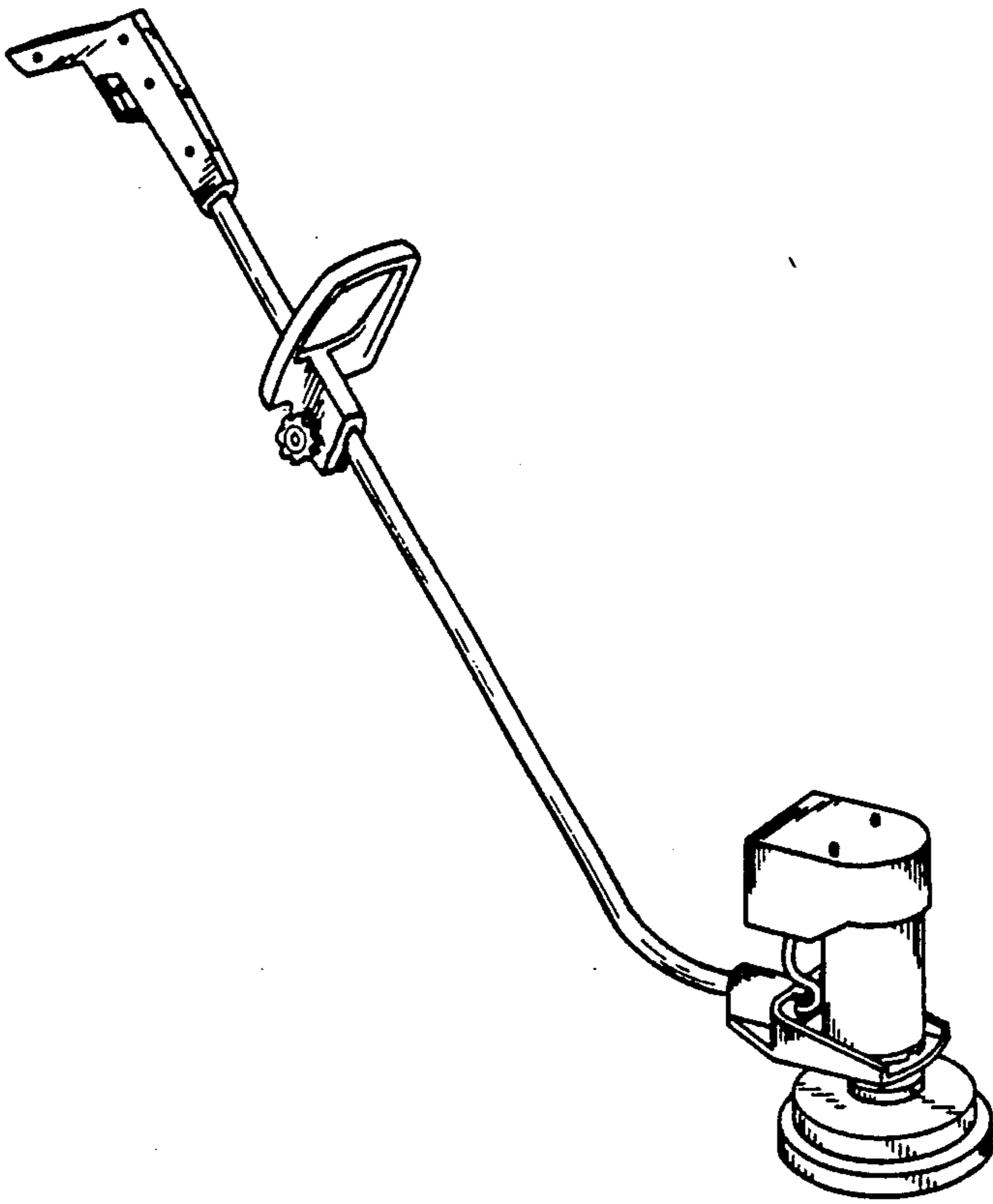

FIG. 1

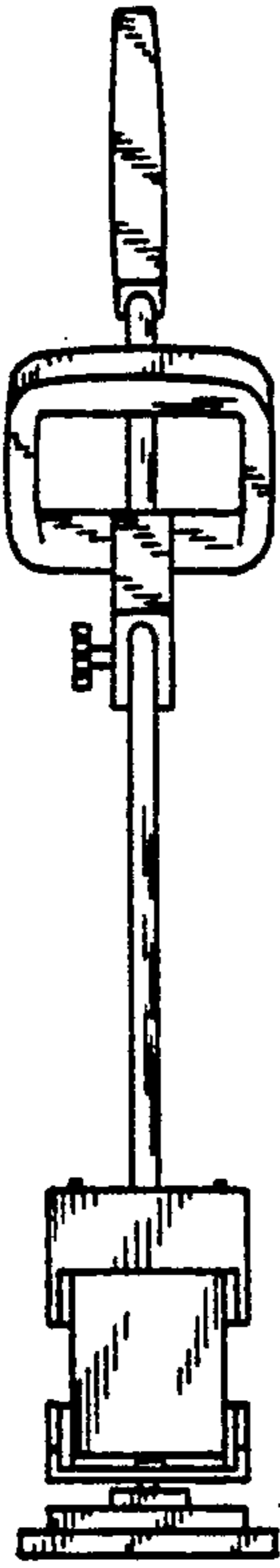

FIG. 2

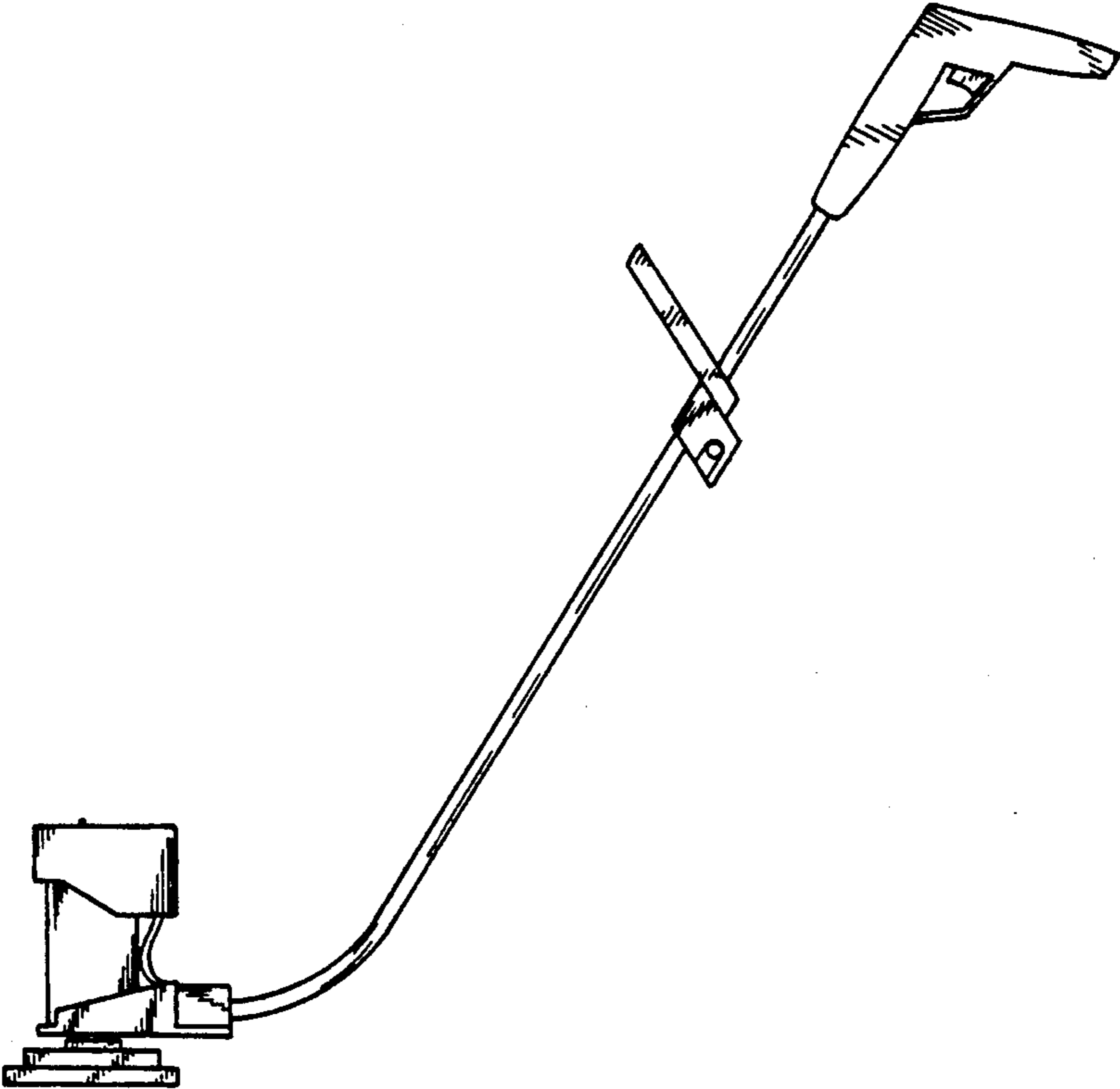

FIG. 3

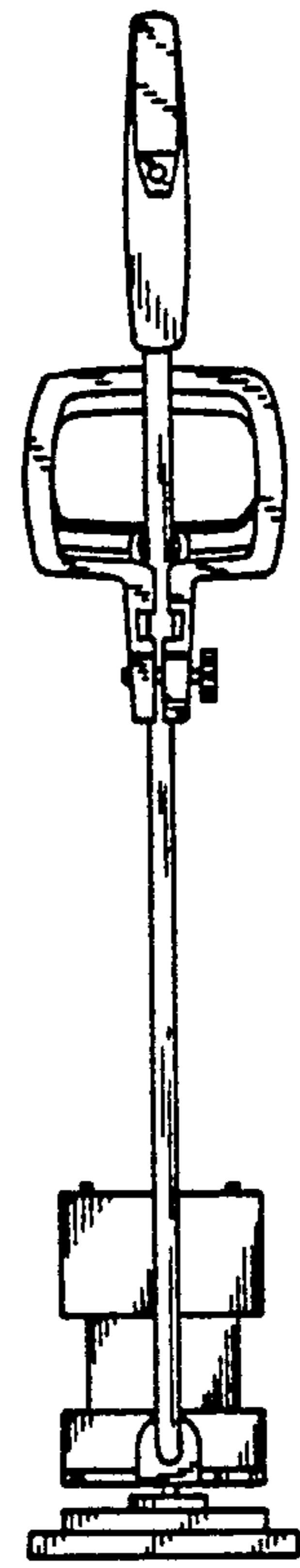

FIG. 4

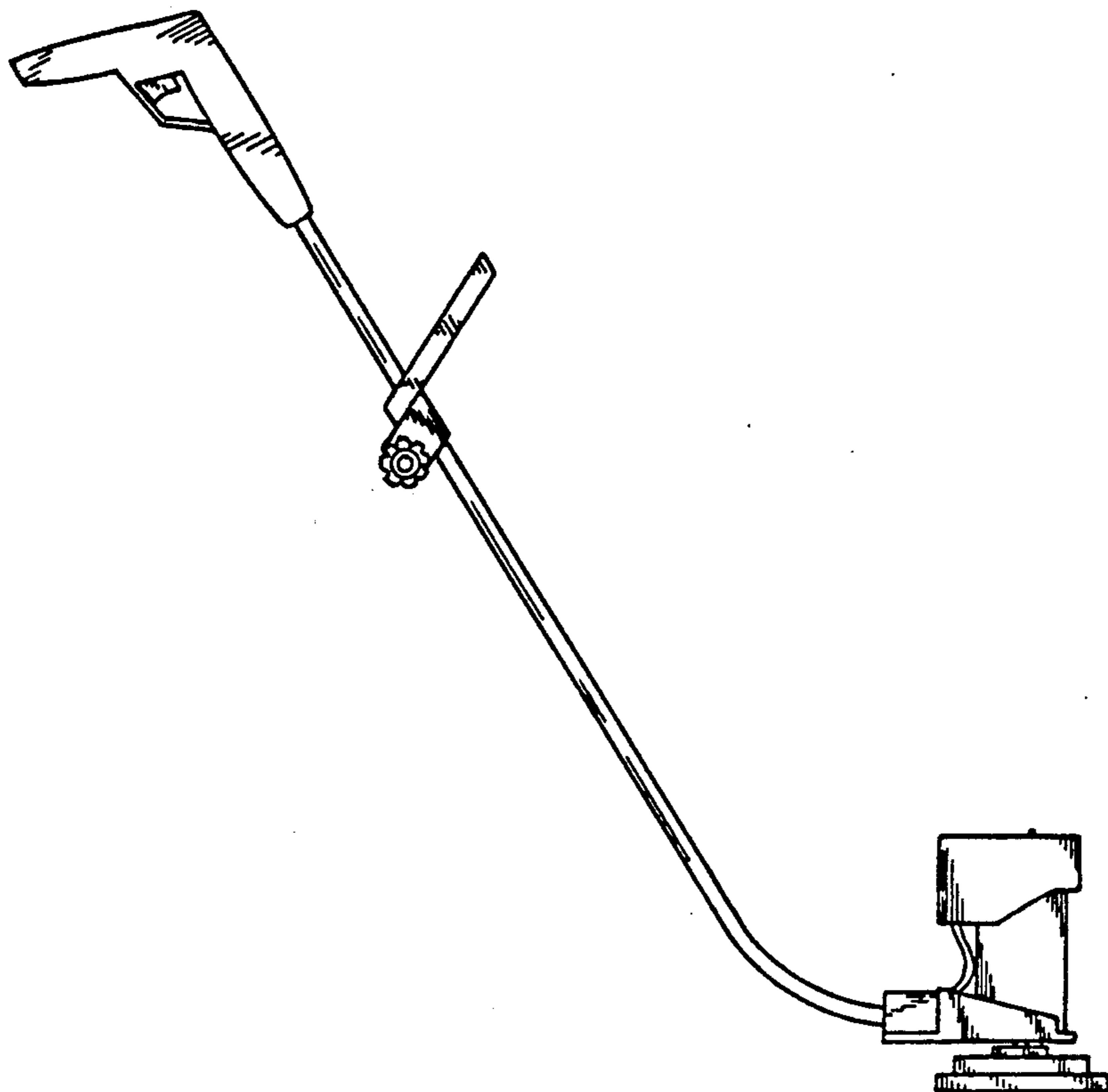

FIG. 5

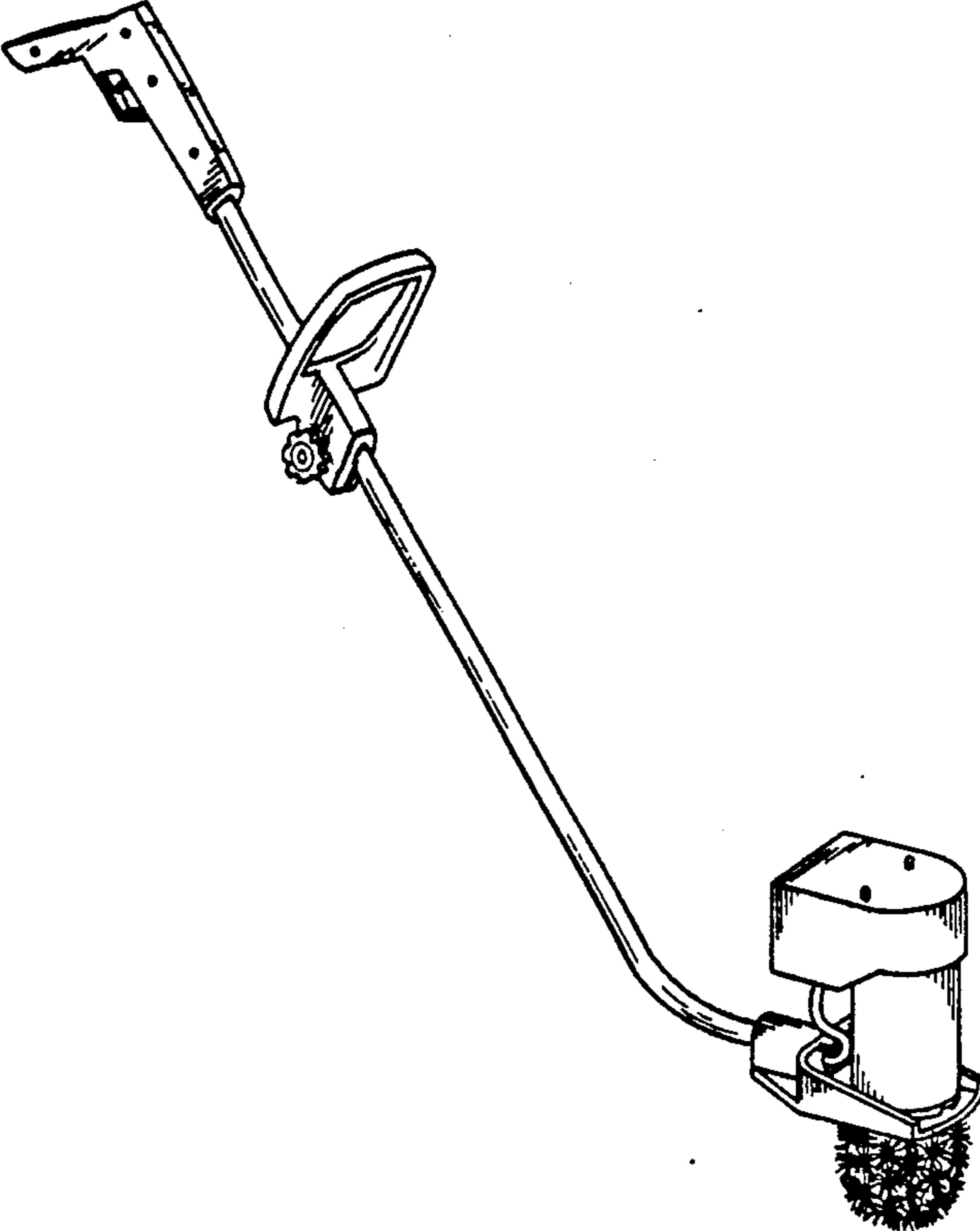

FIG. 6

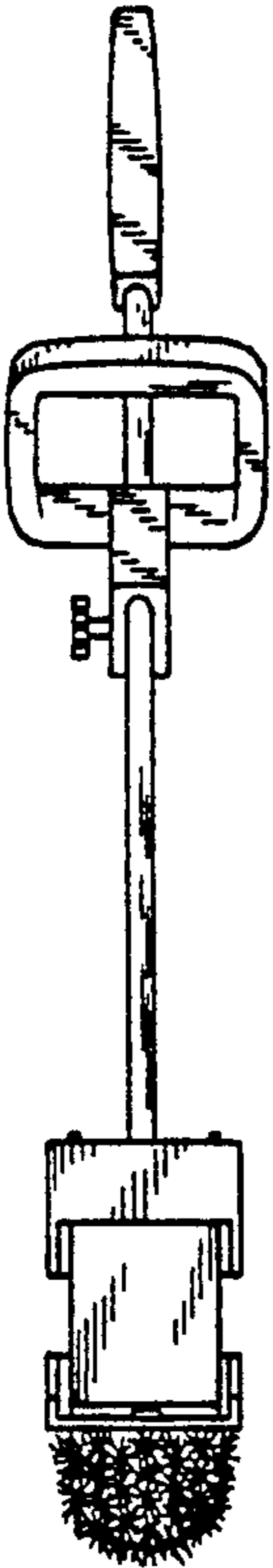

FIG. 7

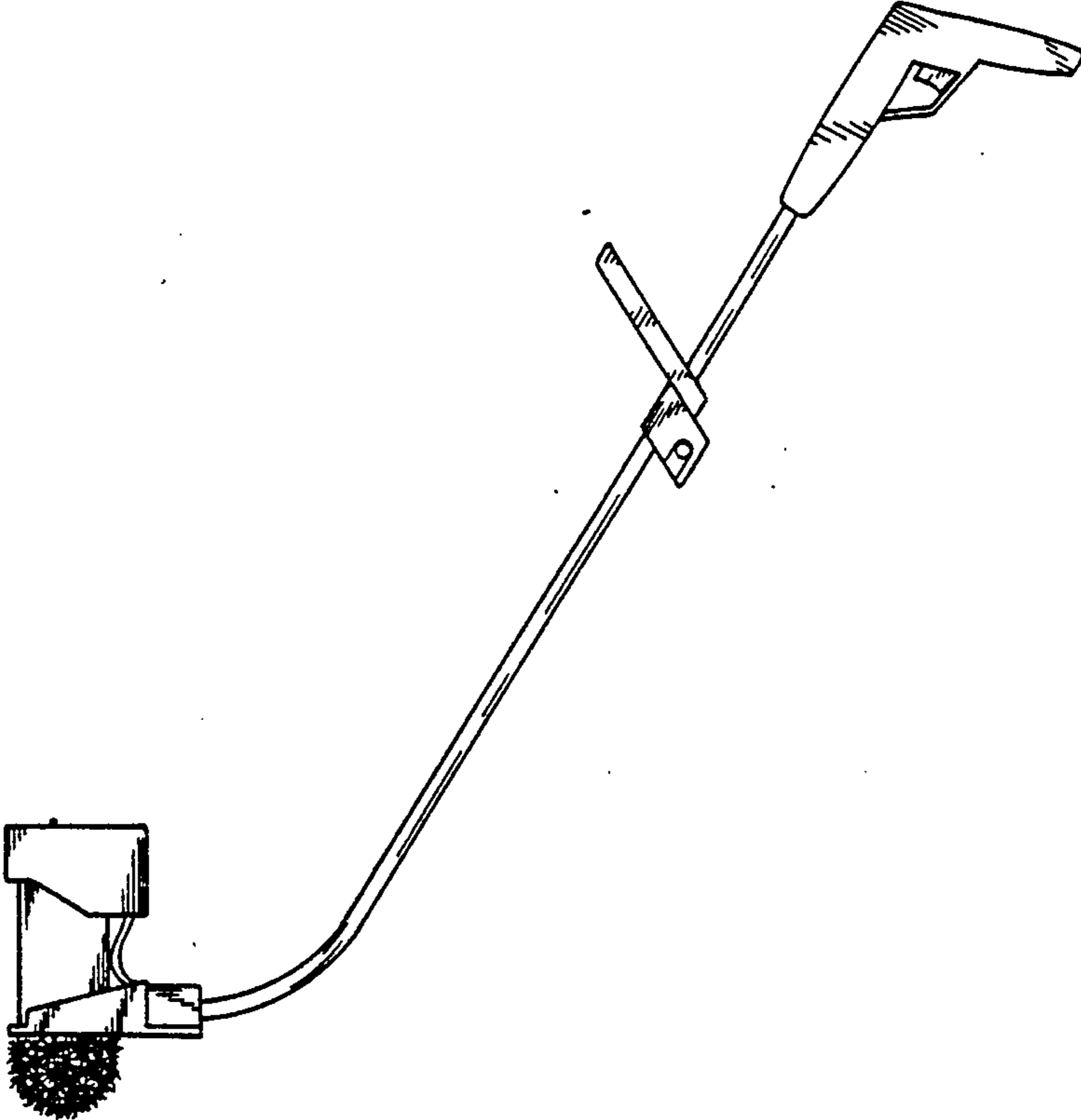

FIG. 8

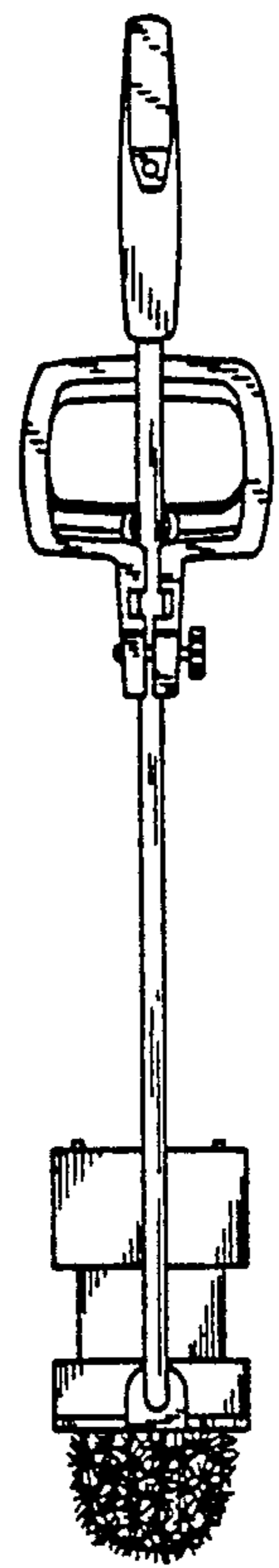

FIG. 9

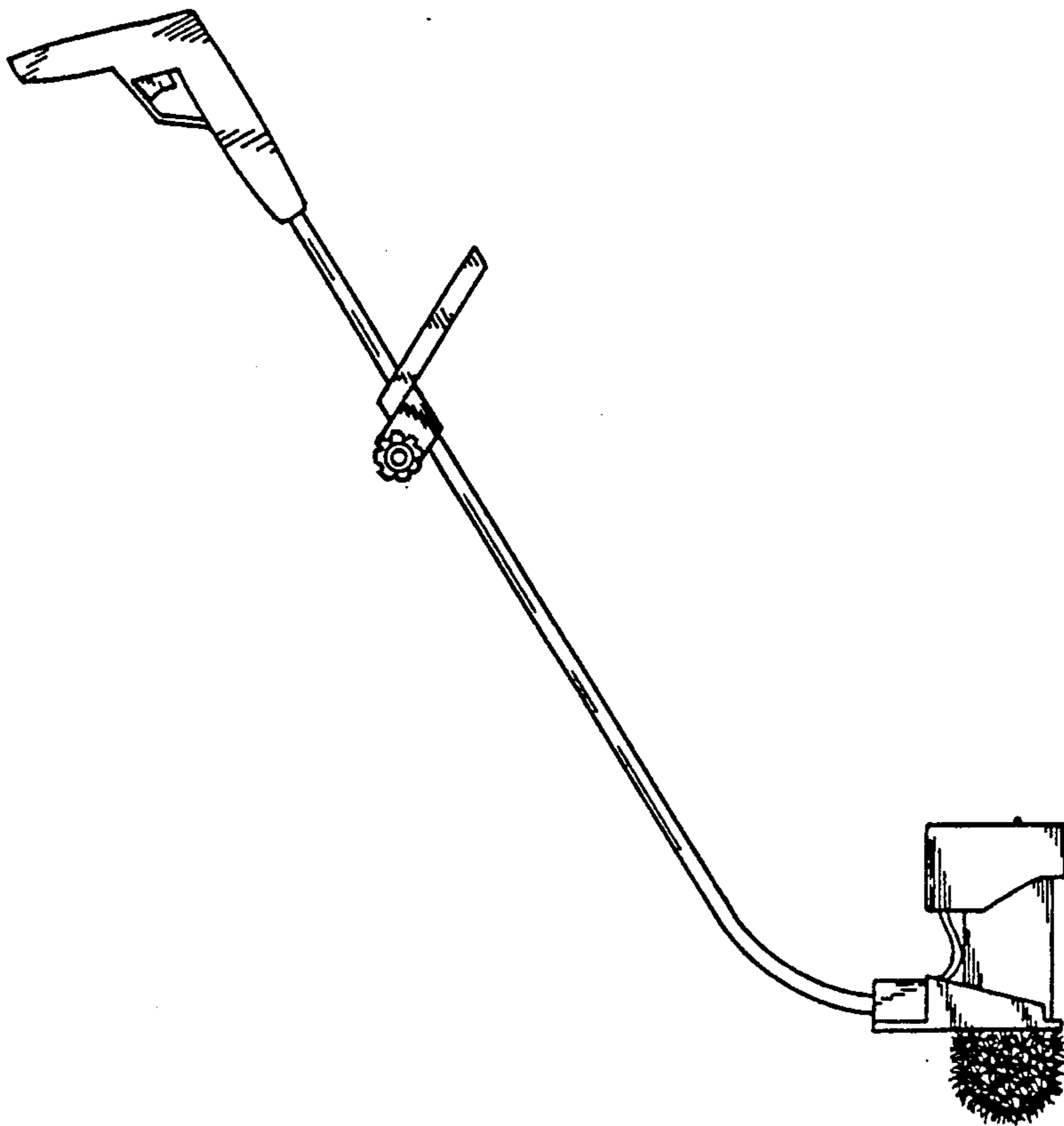

FIG. 10