

[54] FAUCET

[75] Inventor: Kevin W. Rosenbaum, Parma, Ohio

[73] Assignee: Moen Incorporated, Windsor, Conn.

[**] Term: 14 Years

[21] Appl. No.: 142,221

[22] Filed: Jan. 11, 1988

[52] U.S. Cl. D23/238

[58] Field of Search D23/238-243,
D23/255-257; 4/191, 192; 137/801

[56] References Cited

U.S. PATENT DOCUMENTS

| | | | | |
|------------|---------|--------|-------|---------|
| D. 143,175 | 12/1945 | Wagner | | D23/238 |
| D. 224,402 | 7/1972 | Jenner | | D23/241 |
| D. 224,402 | 7/1972 | Jenner | | D23/241 |
| D. 289,076 | 3/1987 | Paul | | D23/238 |

Primary Examiner—James R. Largen

Attorney, Agent, or Firm—Kinzer, Plyer, Dorn,
McEachran & Jambor

[57] CLAIM

The ornamental design for a faucet, as shown and described.

DESCRIPTION

FIG. 1 is a front elevational view of a faucet showing my new design;
 FIG. 2 is a right side elevational view thereof;
 FIG. 3 is a top plan view thereof;
 FIG. 4 is a rear elevational view thereof;
 FIG. 5 is a left side elevational view thereof;
 FIG. 6 is a bottom plan view thereof;
 FIG. 7 is a front elevational view showing the faucet in an open position;
 FIG. 8 is a top plan view of FIG. 7;
 FIG. 9 is a left side elevational view of FIG. 7;
 FIG. 10 is a rear elevational view of FIG. 7;
 FIG. 11 is a right side elevational view of FIG. 7; and
 FIG. 12 is a bottom plan view of FIG. 7.

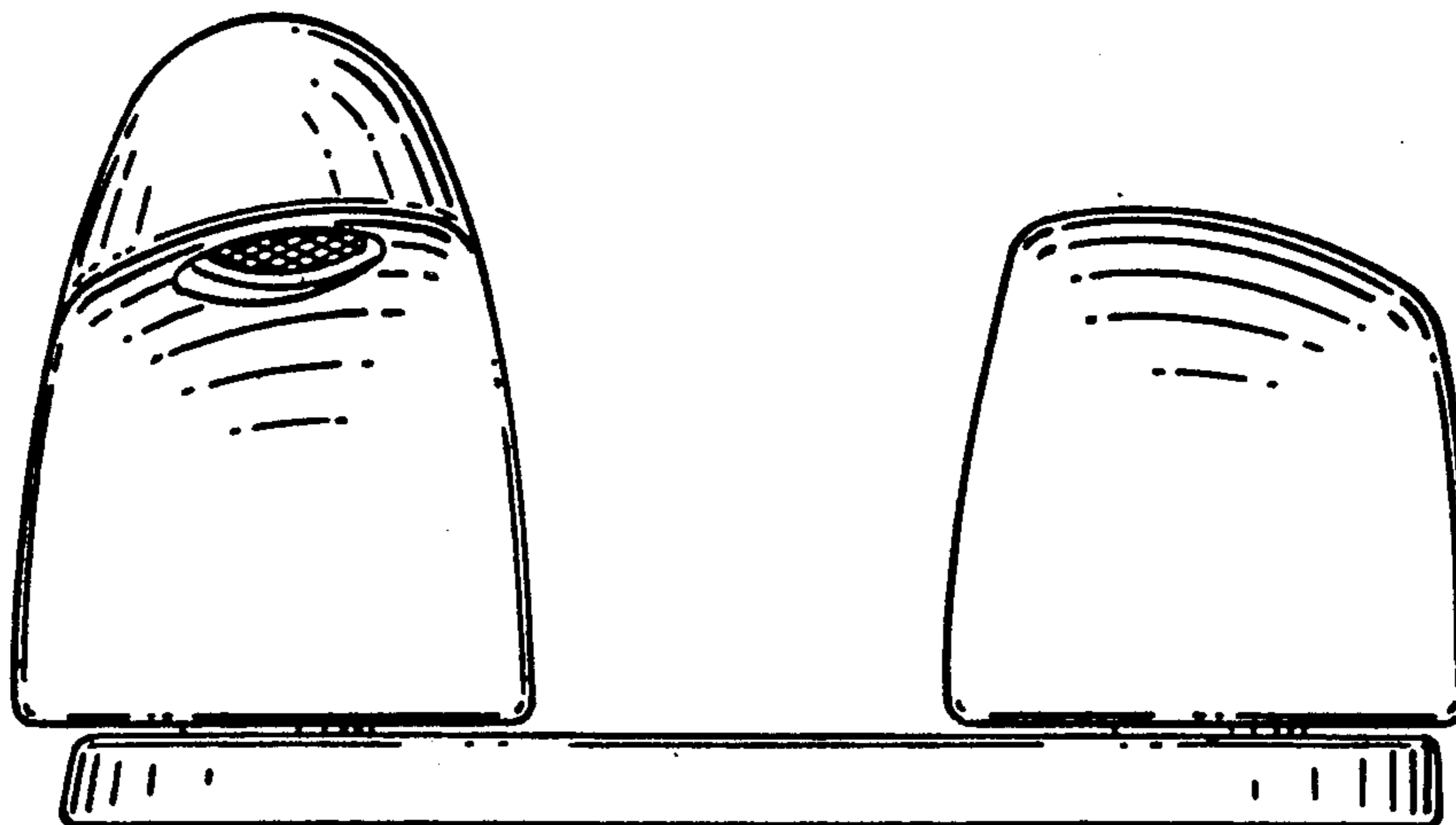
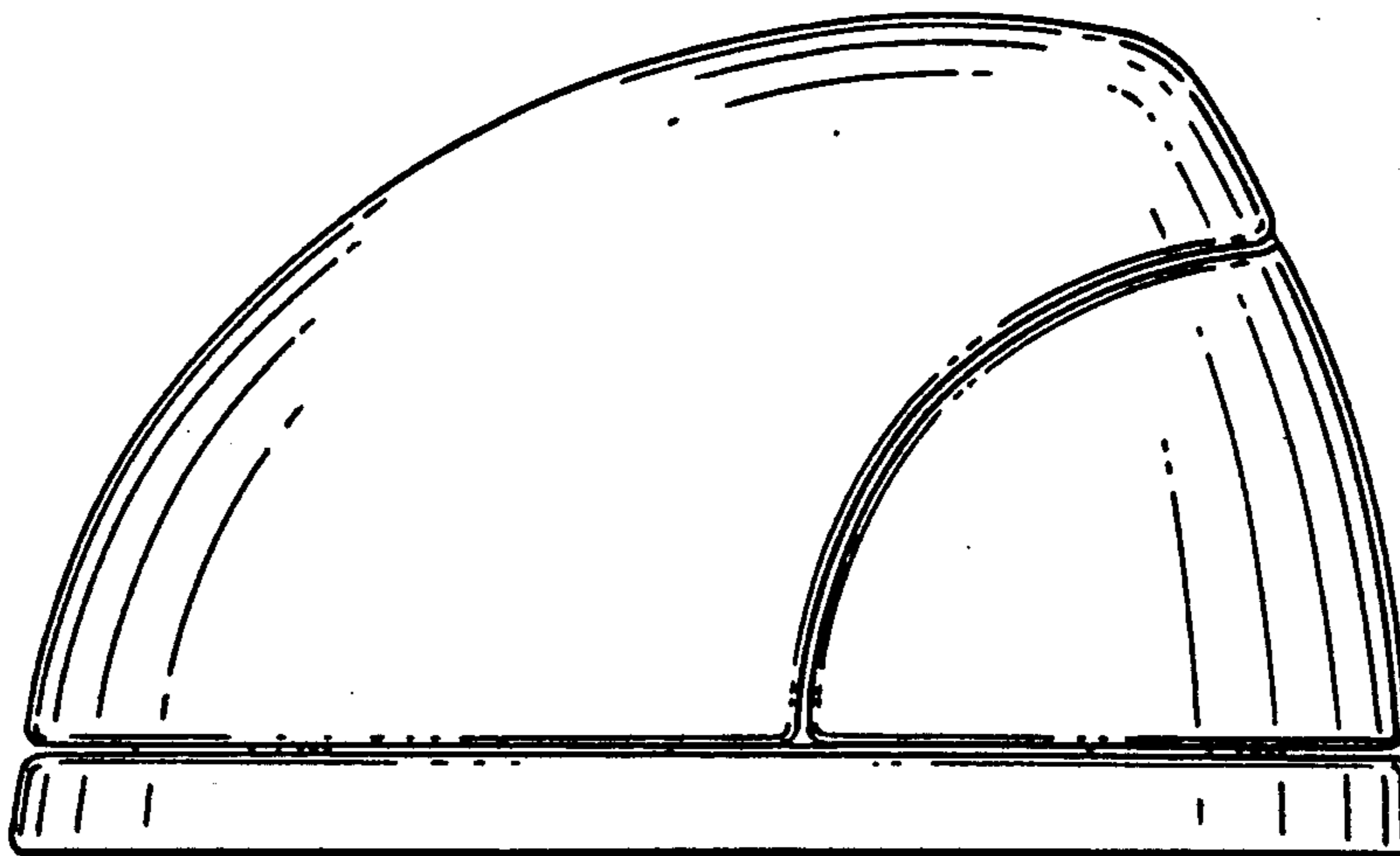

FIG. 1.

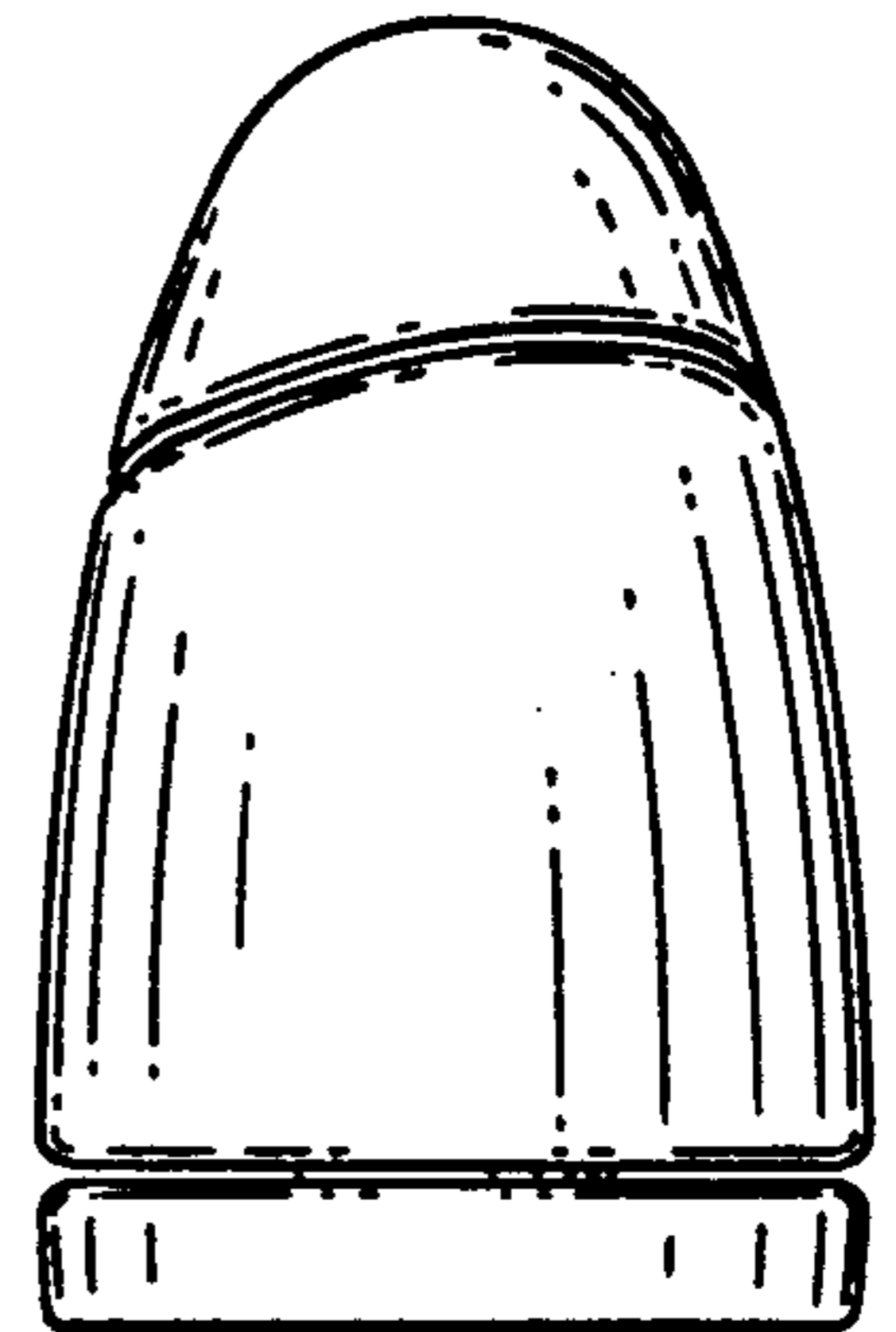
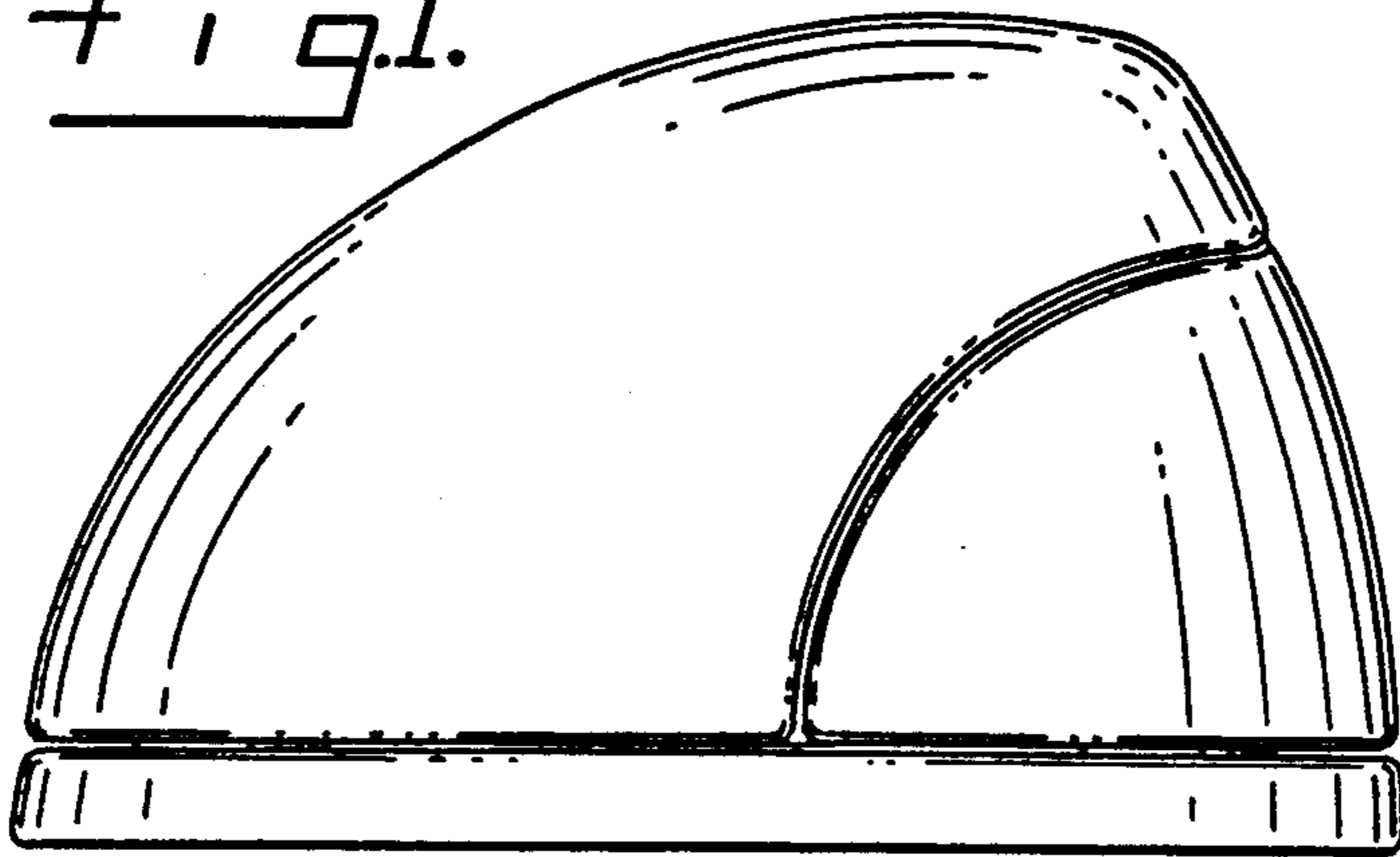

FIG. 2.



FIG. 3.

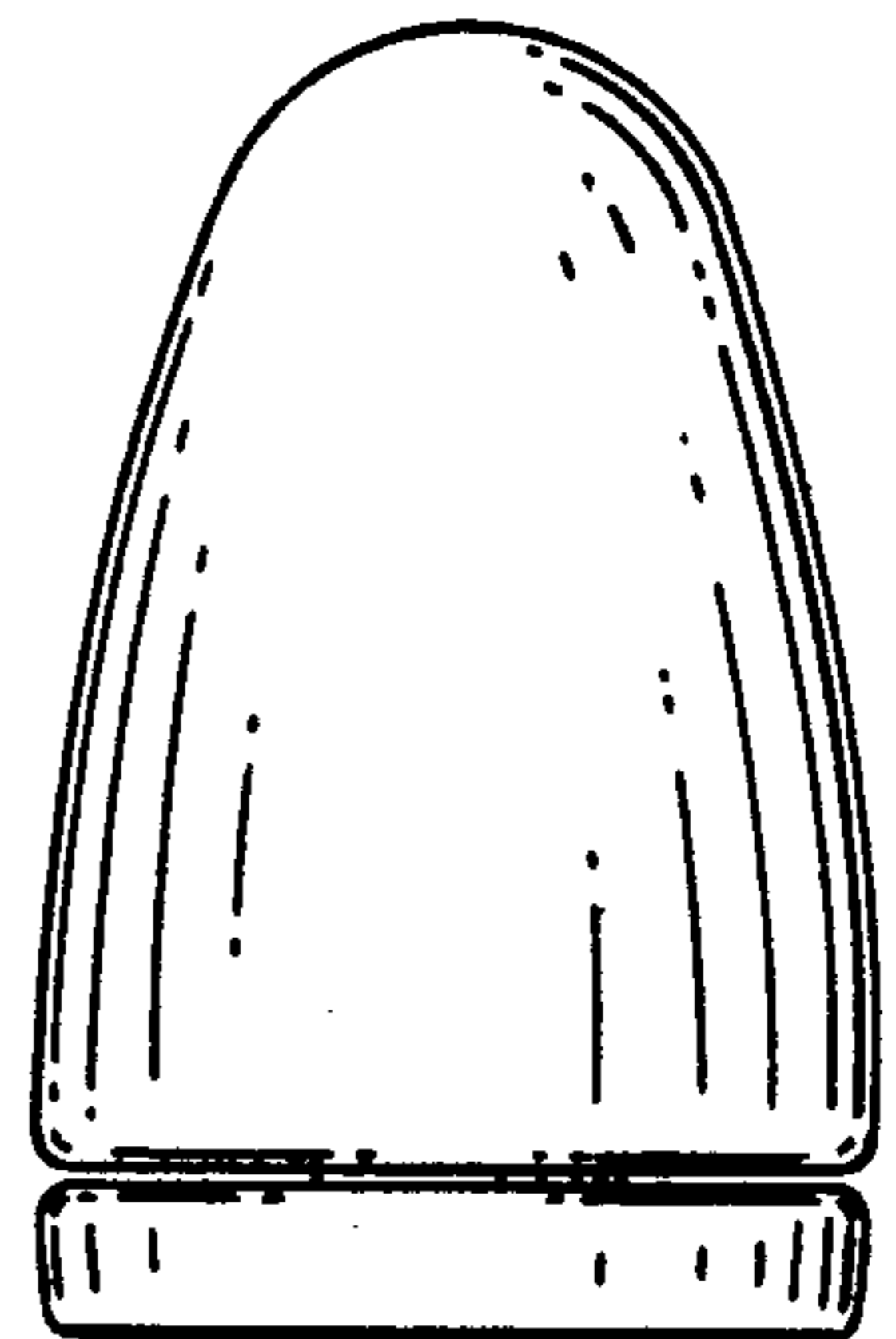

FIG. 5.

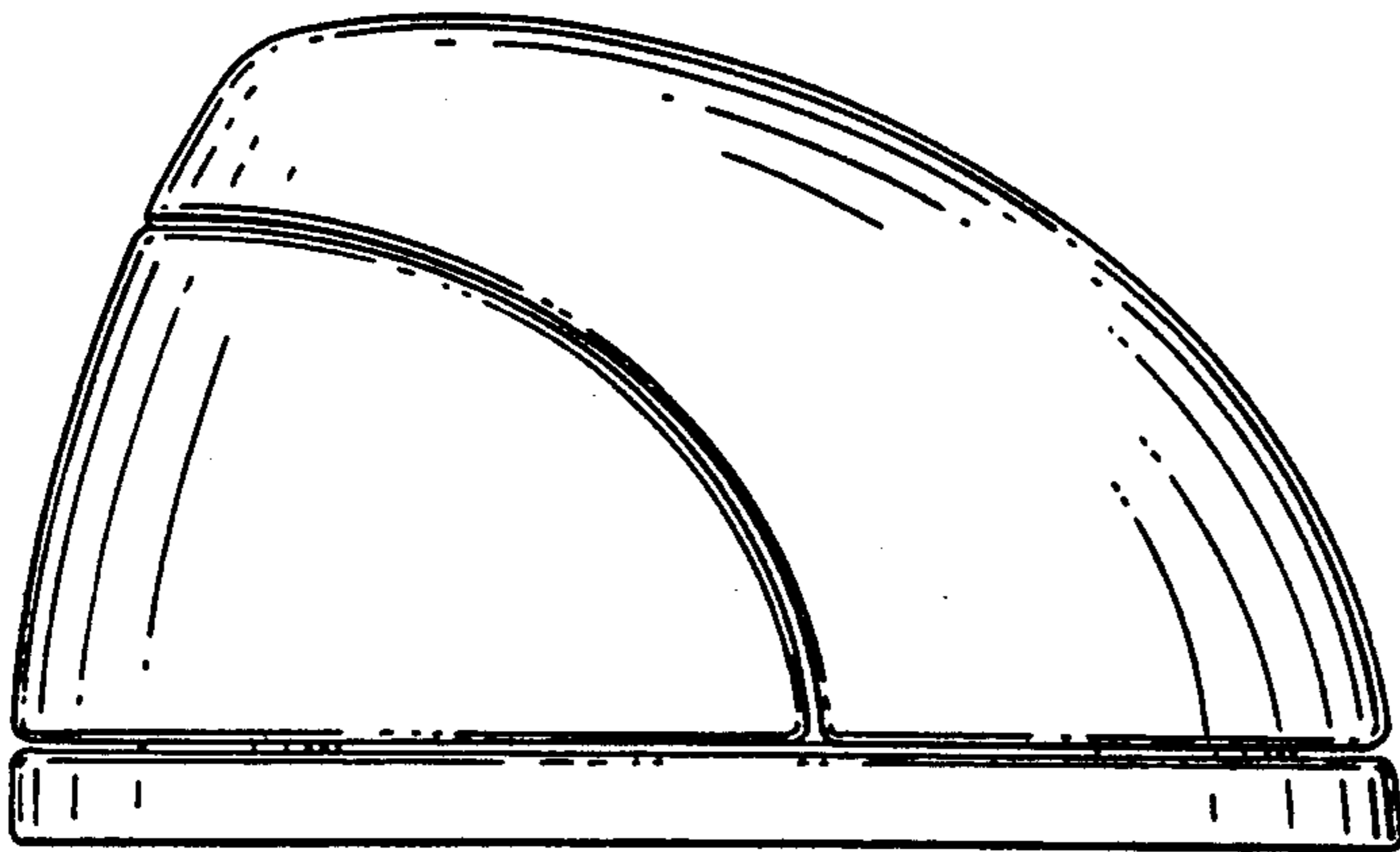

FIG. 4.

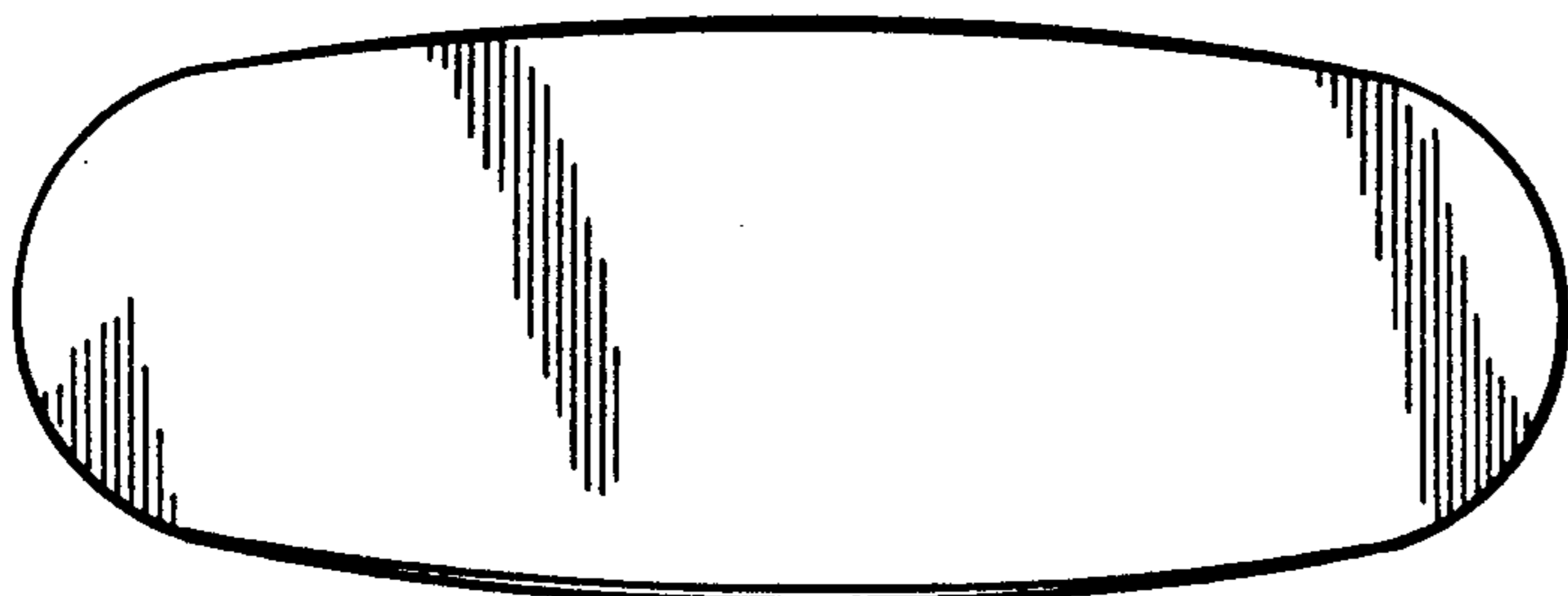

FIG. 6.

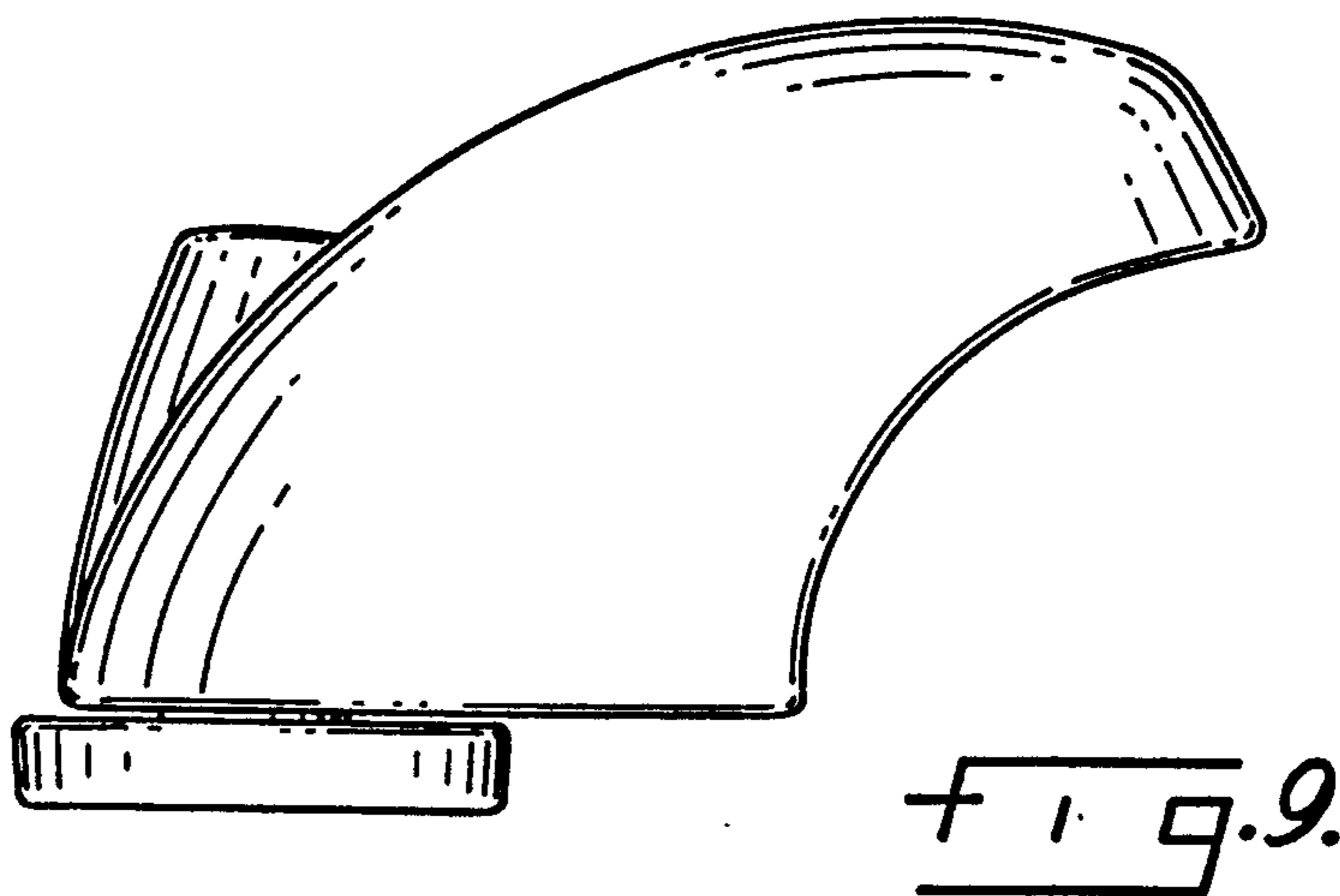
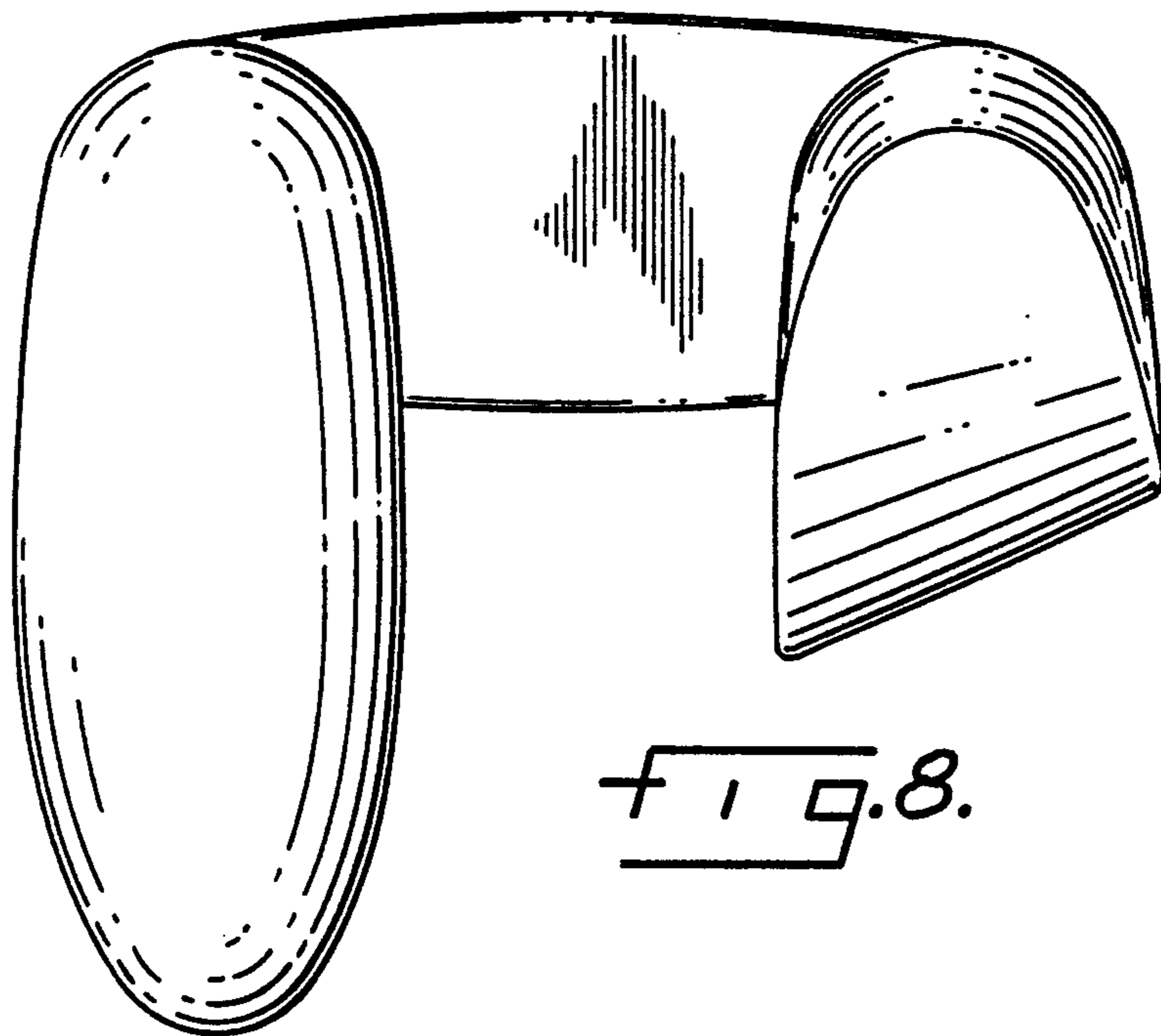
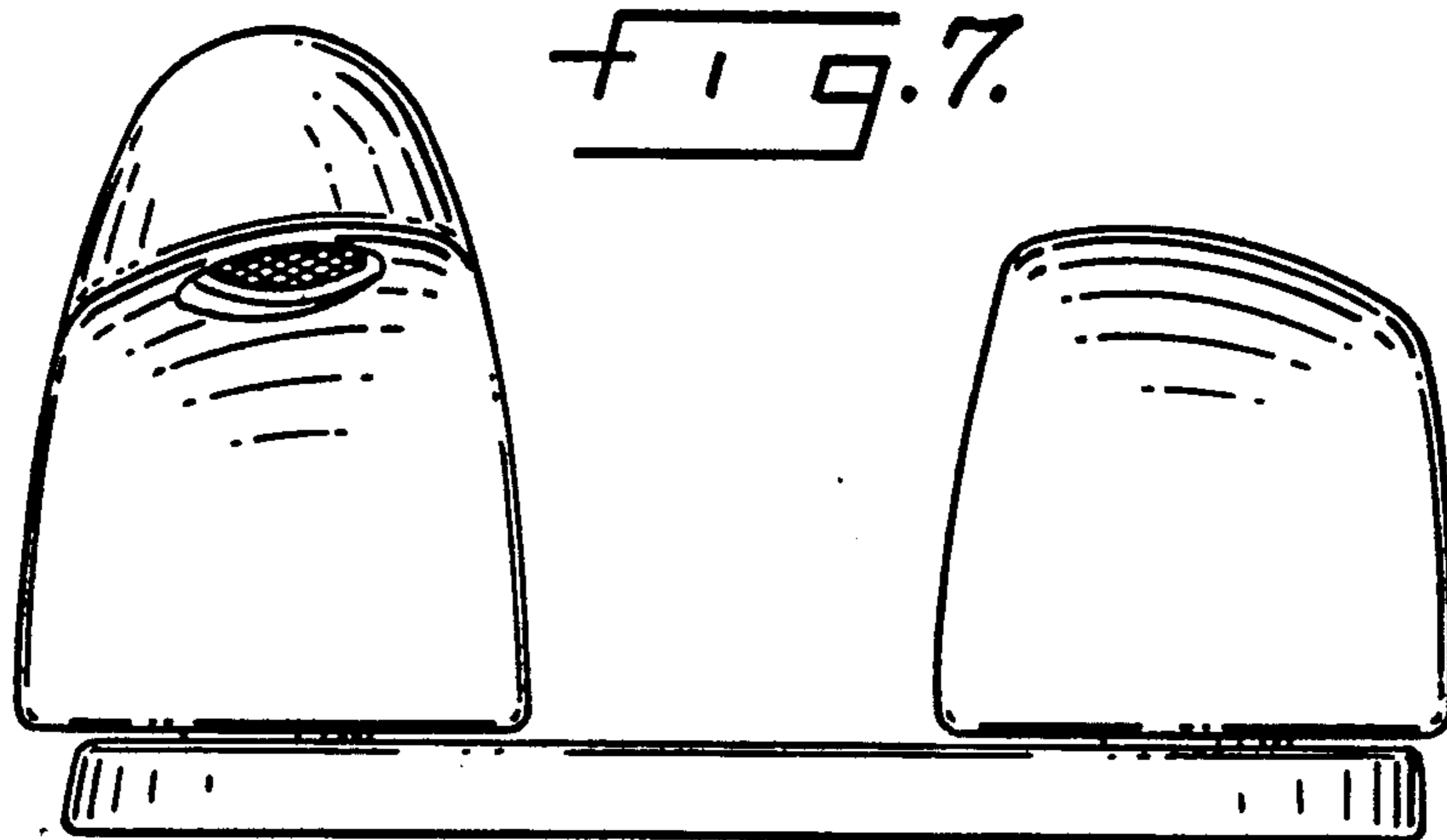

Fig. 10.

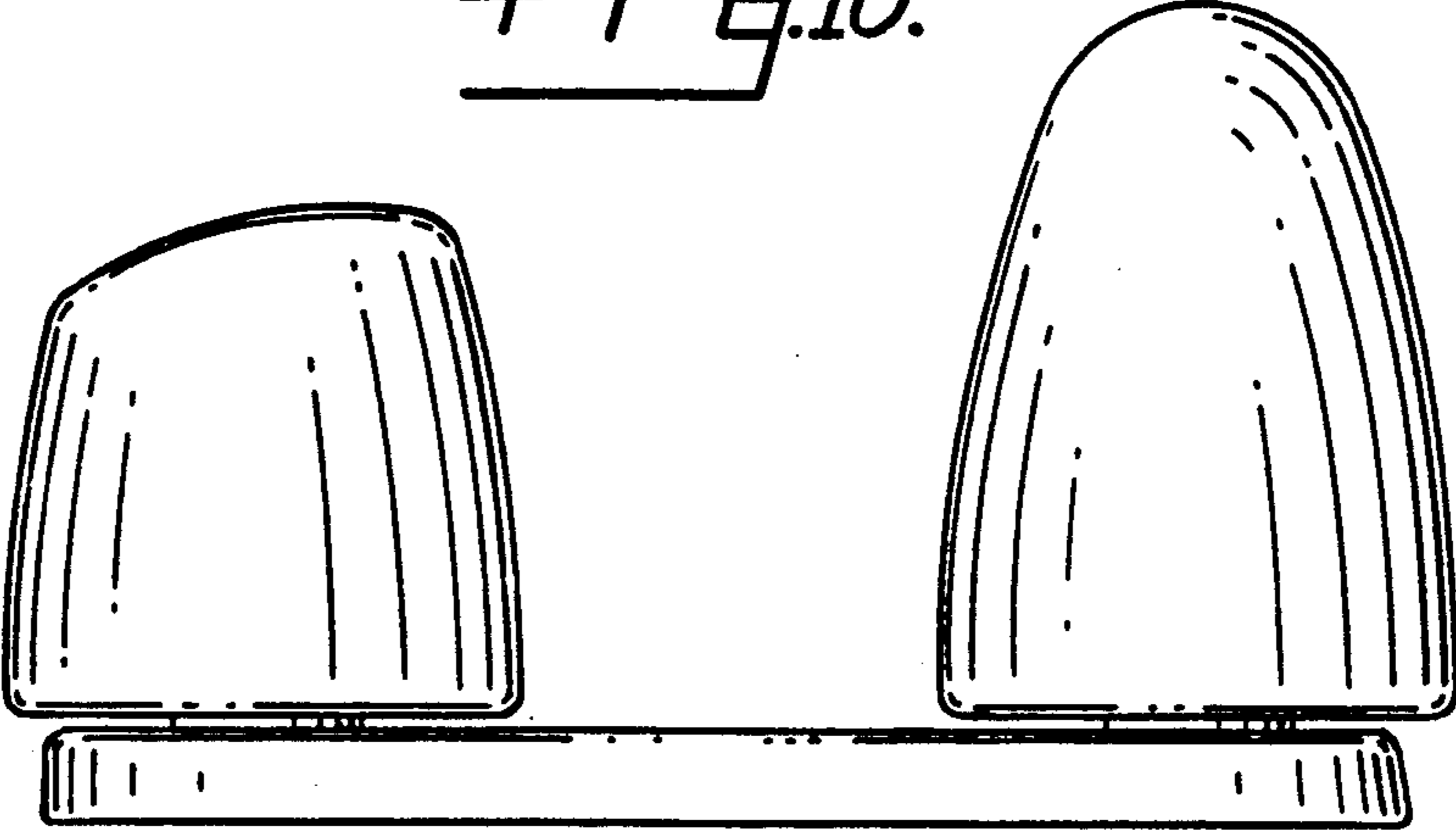

Fig. 11.

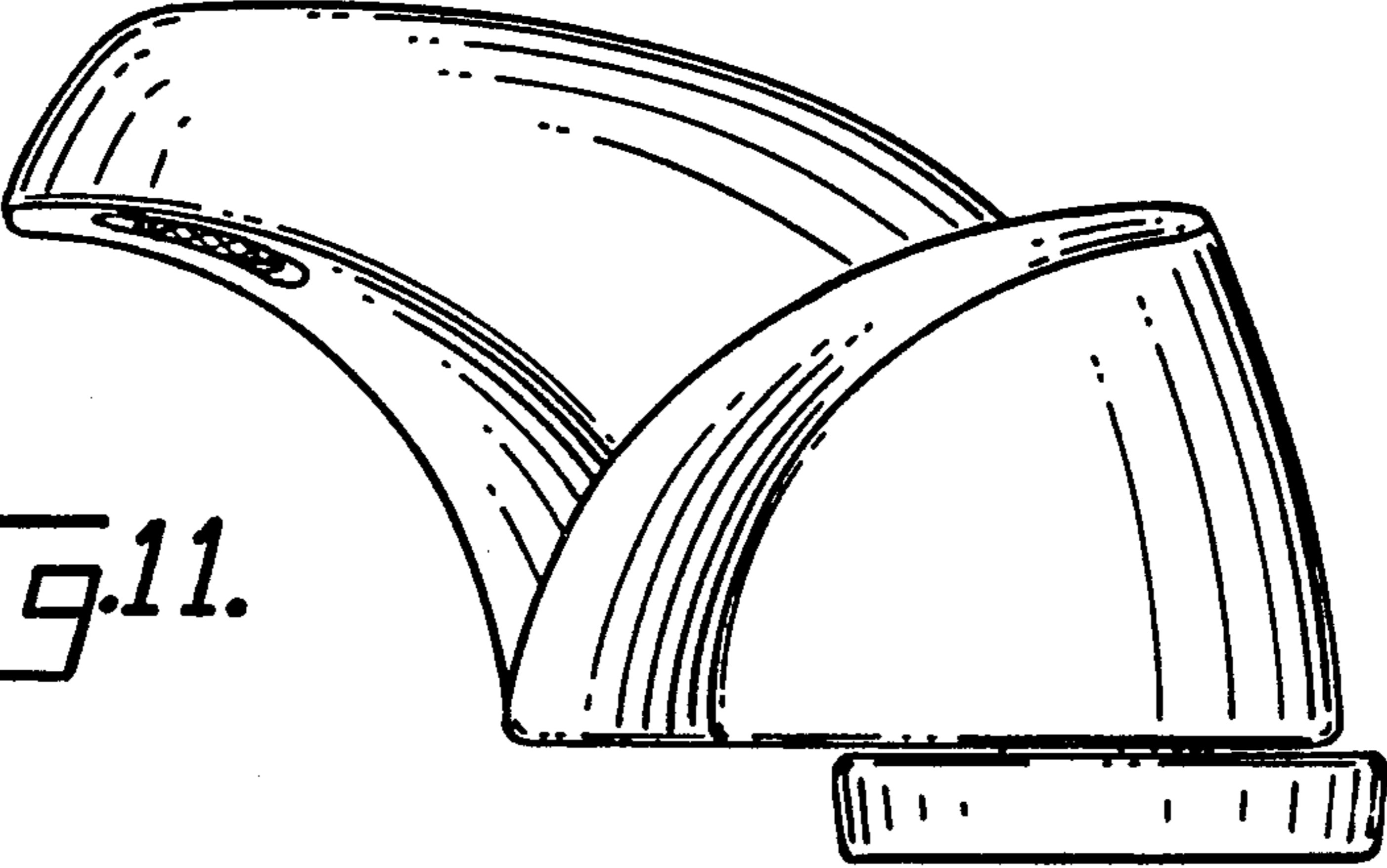

Fig. 12.

