

[54] HOLDER FOR ASSORTED DESK ARTICLES

[76] Inventor: Theodore P. Lapadakis, 9827 Mason Ave., Chatsworth, Calif. 91311

[\*\*] Term: 14 Years

[21] Appl. No.: 164,993

[22] Filed: Mar. 7, 1988

[52] U.S. Cl. .... D19/75; D19/77; D19/78; D19/95

[58] Field of Search ..... D19/65, 75, 77, 78, D19/81, 84, 85, 92, 90, 95, 99, 100; 206/224, 214, 371; 211/69.1-69.9

[56] References Cited

U.S. PATENT DOCUMENTS

D. 129,724	9/1941	Gardner	.....	D19/90 X
D. 270,256	8/1983	Sankey	.....	D19/90 X
D. 288,827	3/1987	Wolff	.....	D19/78
D. 290,852	7/1987	Wang	.....	D19/78 X
D. 295,540	5/1988	Rabig	.....	D19/90 X
4,700,829	10/1987	Goodyear	.....	D19/90 X

Primary Examiner—Bruce W. Dunkins

Assistant Examiner—Martha Thompson  
Attorney, Agent, or Firm—Kelly, Bauersfeld & Lowry

[57] CLAIM

The ornamental design for a holder assorted desk articles, as shown and described.

DESCRIPTION

FIG. 1 is a top, left perspective view of a holder for assorted desk articles, showing my new design;  
 FIG. 2 is a top plan view thereof;  
 FIG. 3 is a right side elevational view thereof;  
 FIG. 4 is a front elevational view thereof;  
 FIG. 5 is a left side elevational view thereof;  
 FIG. 6 is a rear elevational view thereof;  
 FIG. 7 is a bottom plan view thereof;  
 FIG. 8 is a top, left perspective view of a second embodiment of my new design;  
 FIG. 9 is a top plan view of FIG. 8;  
 FIG. 10 is a right side elevational view of FIG. 8;  
 FIG. 11 is a front elevational view of FIG. 8;  
 FIG. 12 is a left side elevational view of FIG. 8;  
 FIG. 13 is a rear elevational view of FIG. 8; and  
 FIG. 14 is a bottom plan view of FIG. 8.

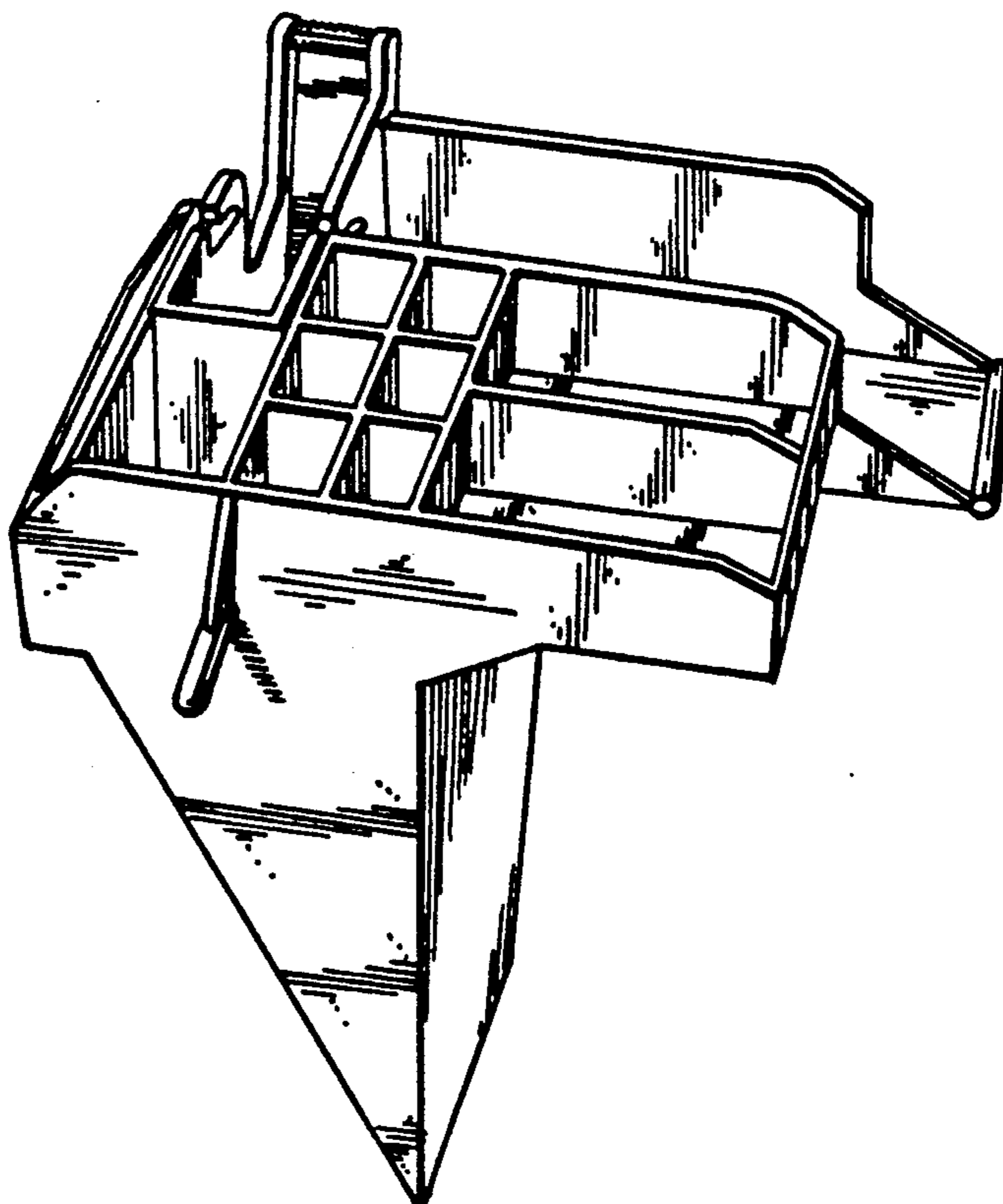

FIG. 1

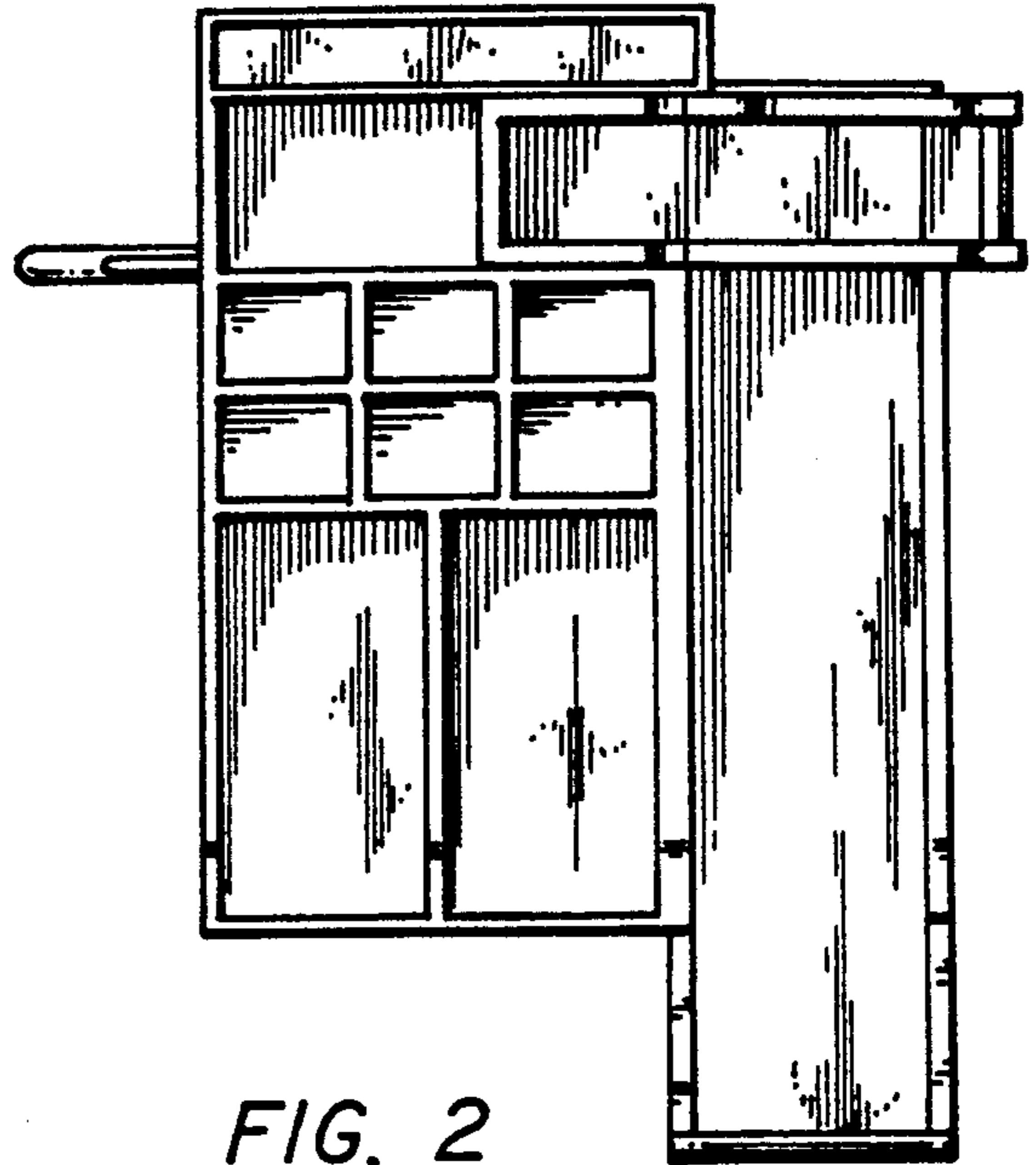
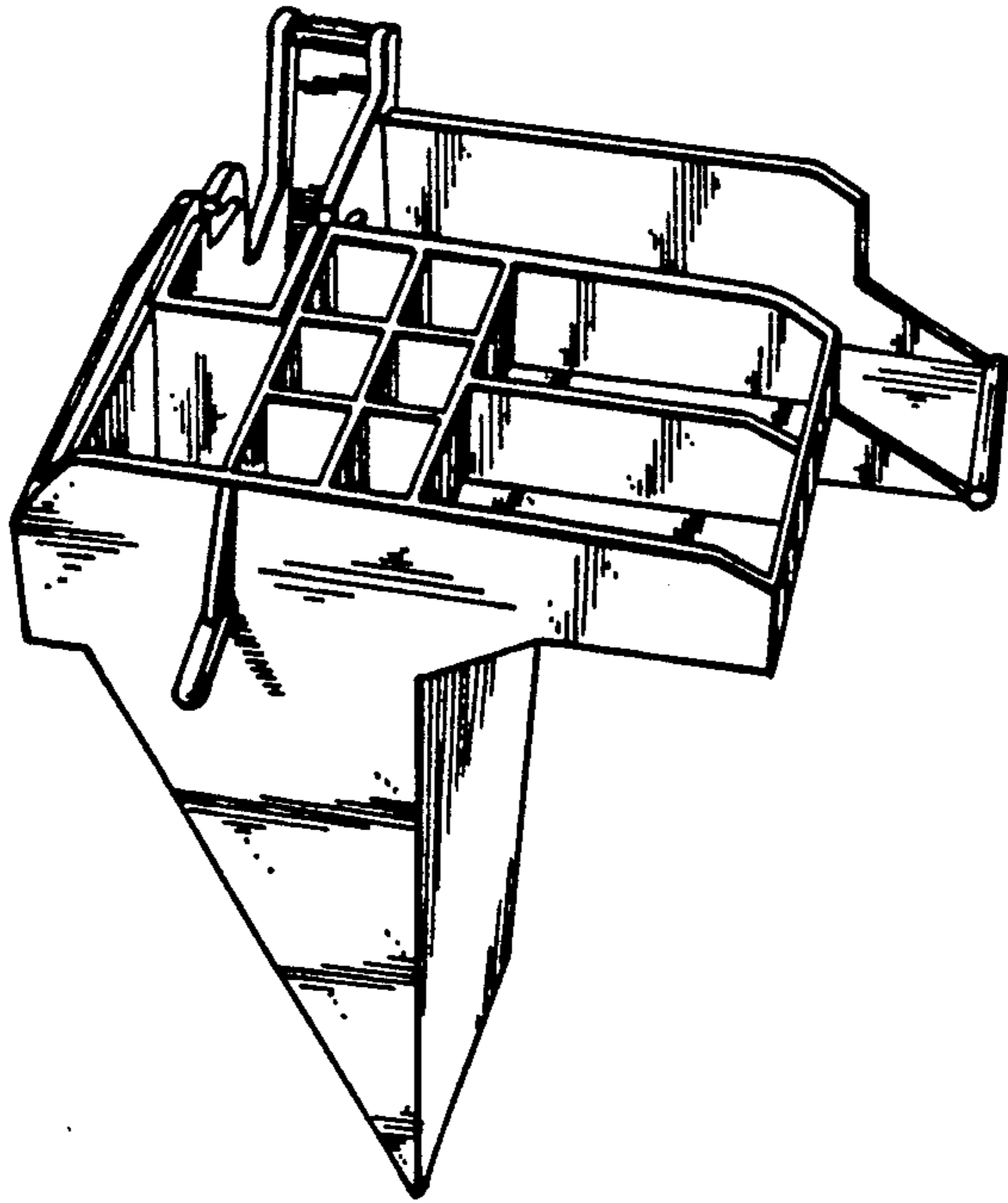

FIG. 2

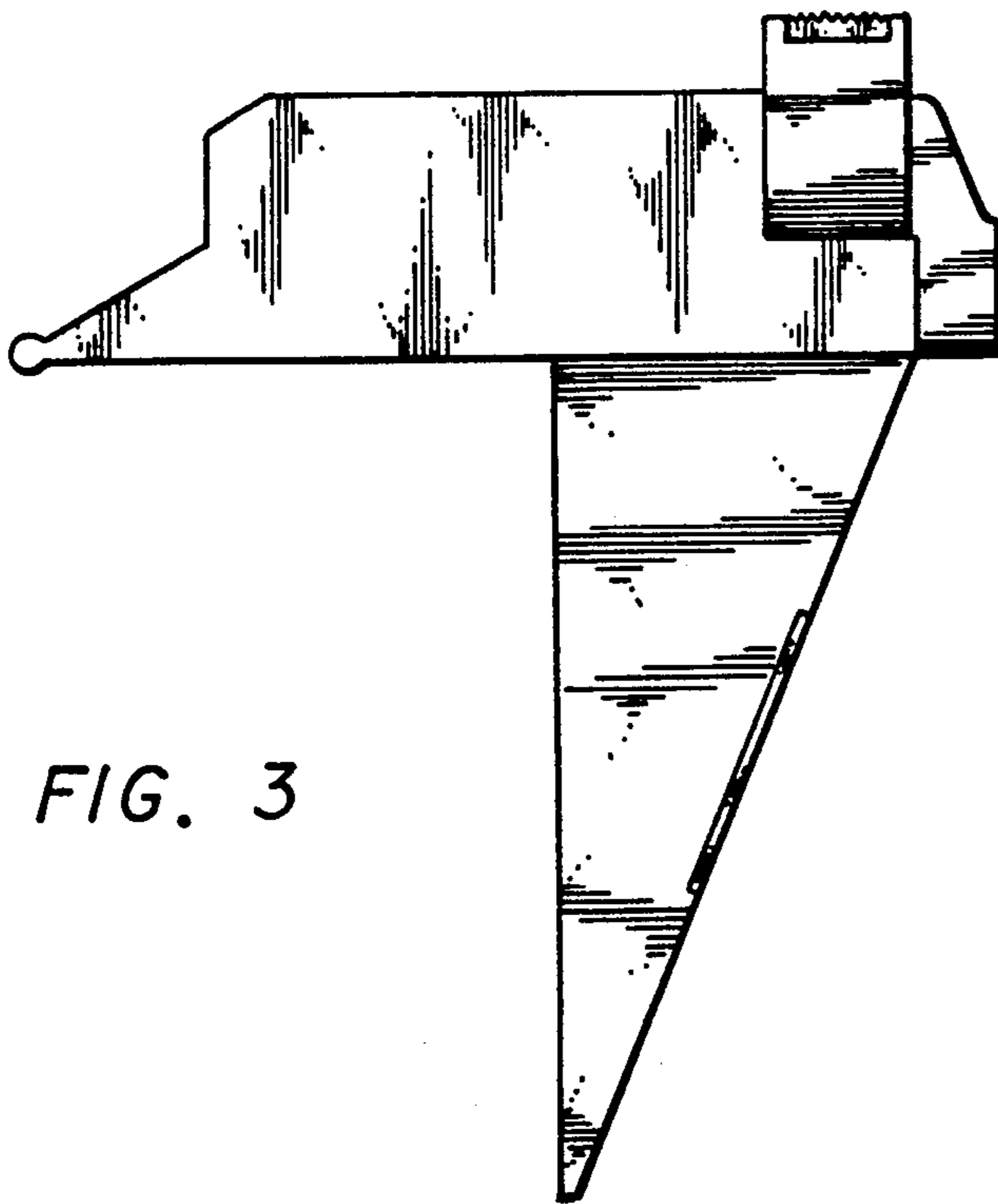

FIG. 3

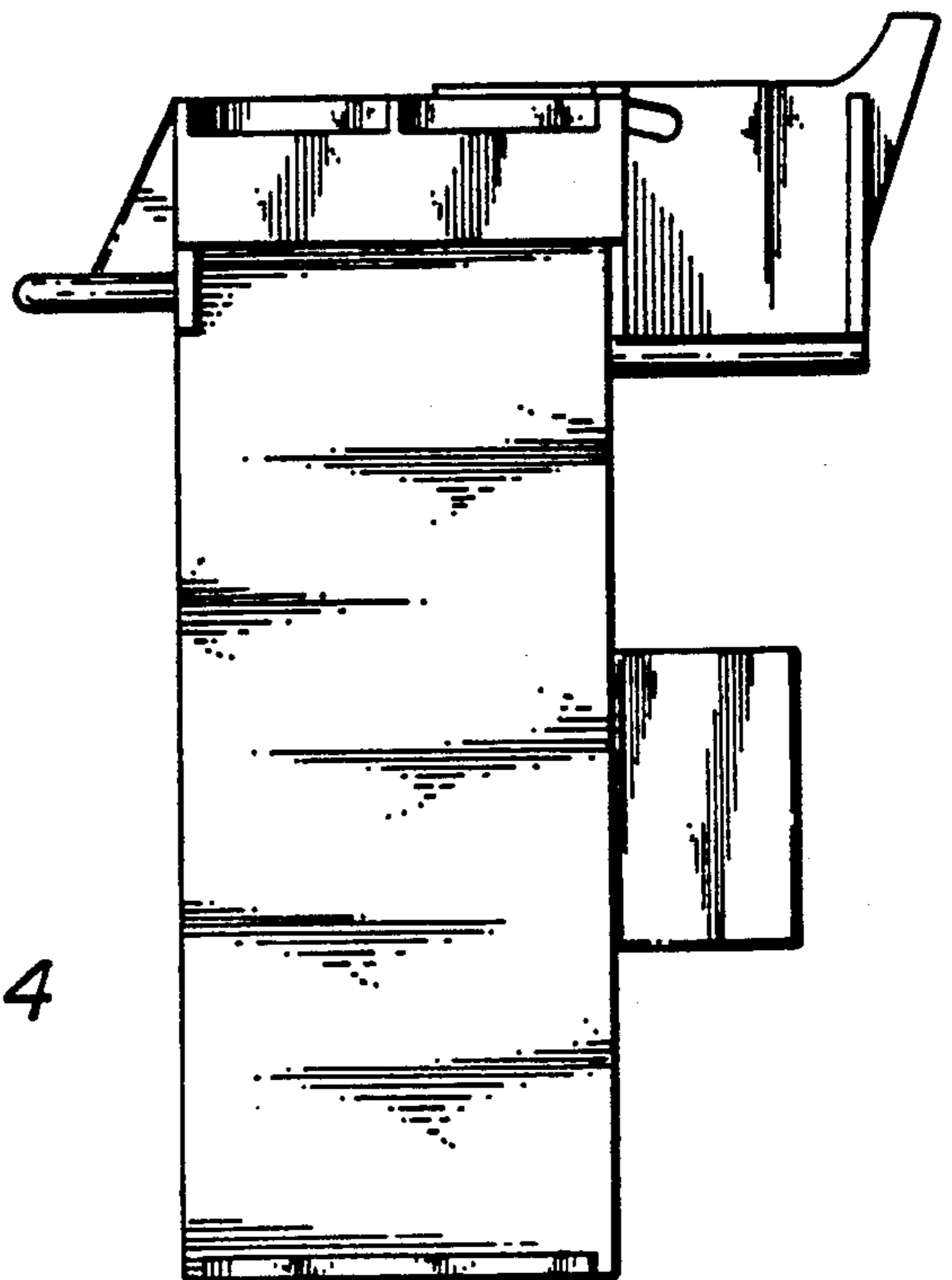

FIG. 4

FIG. 5

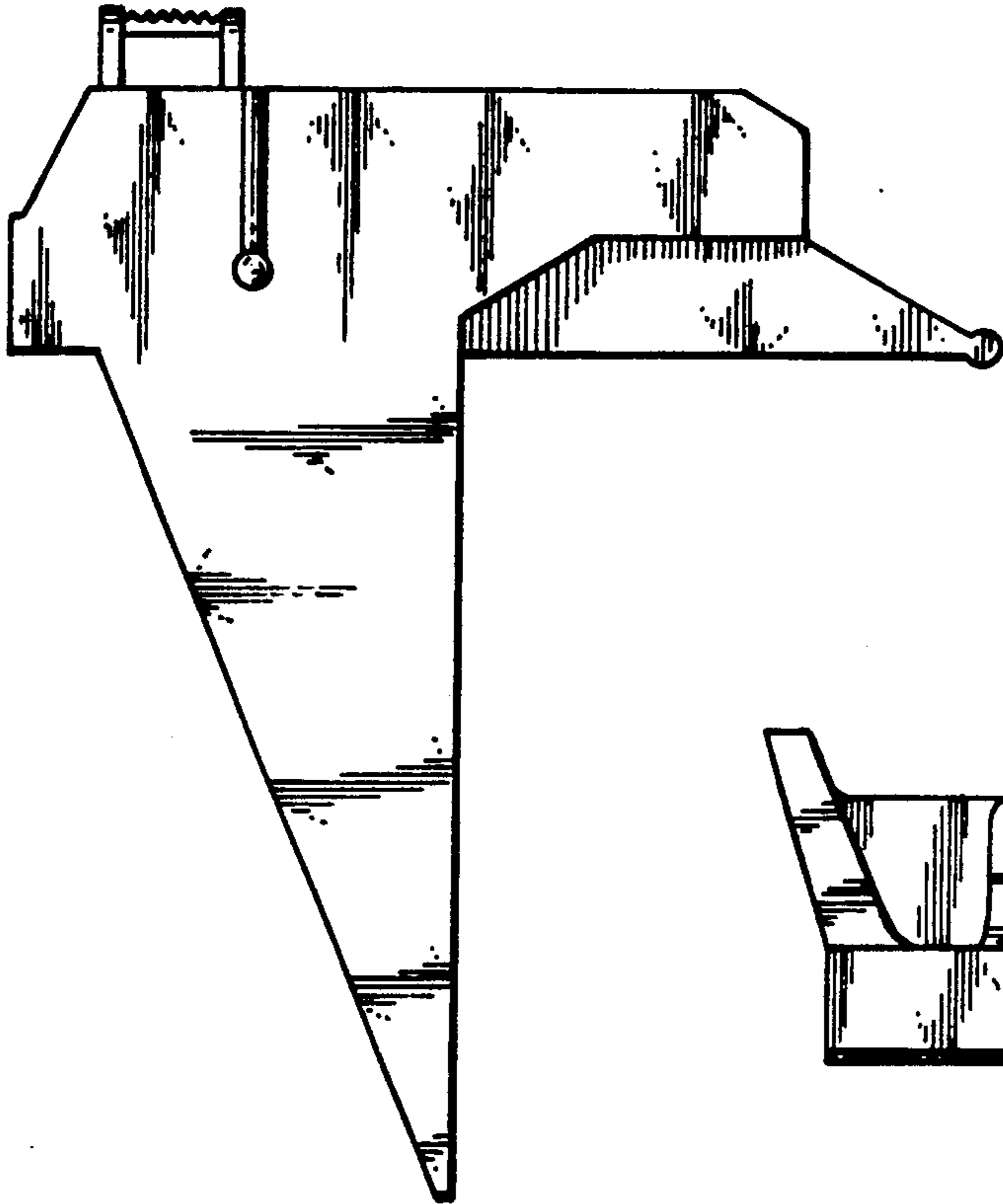

FIG. 6

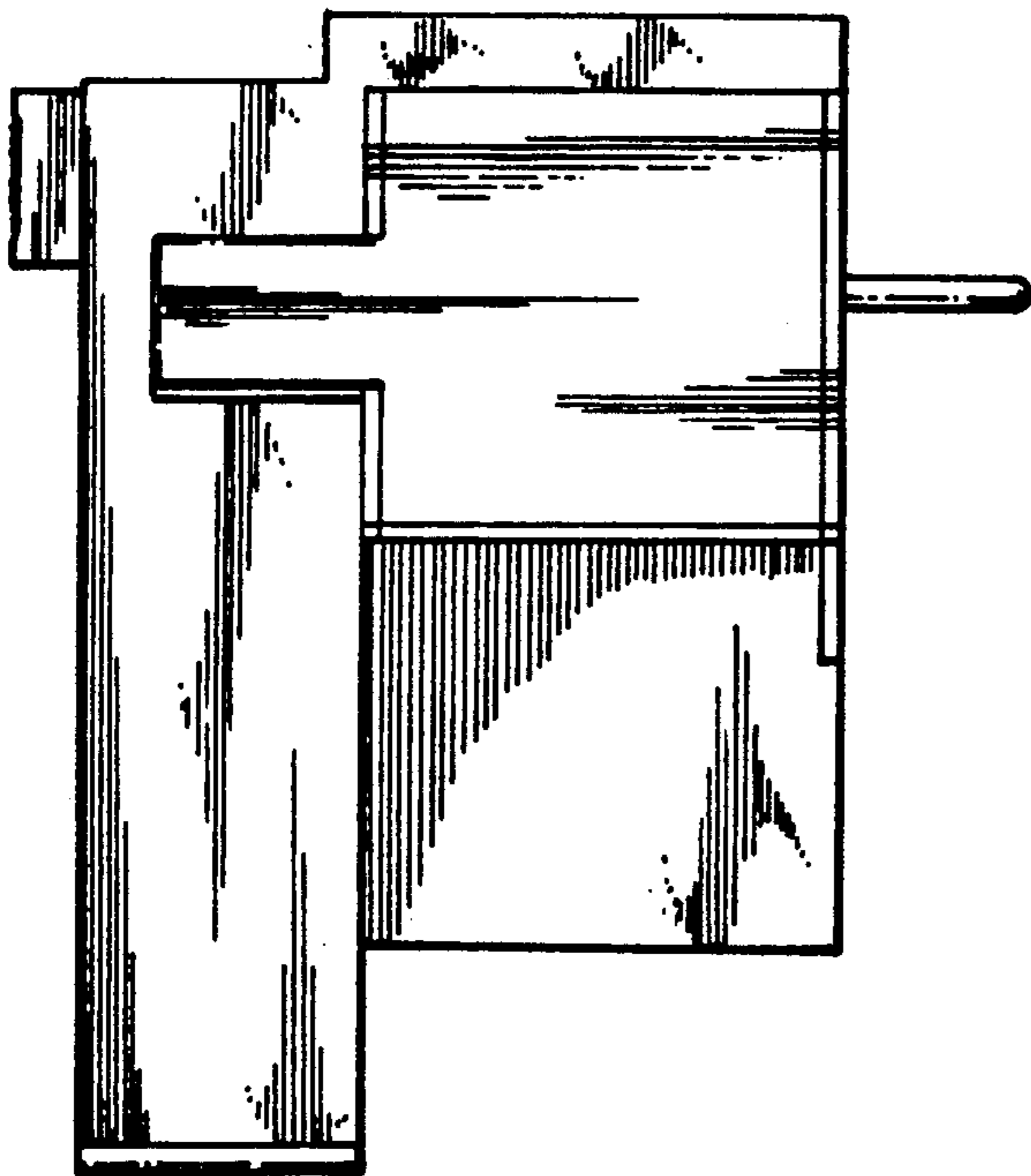
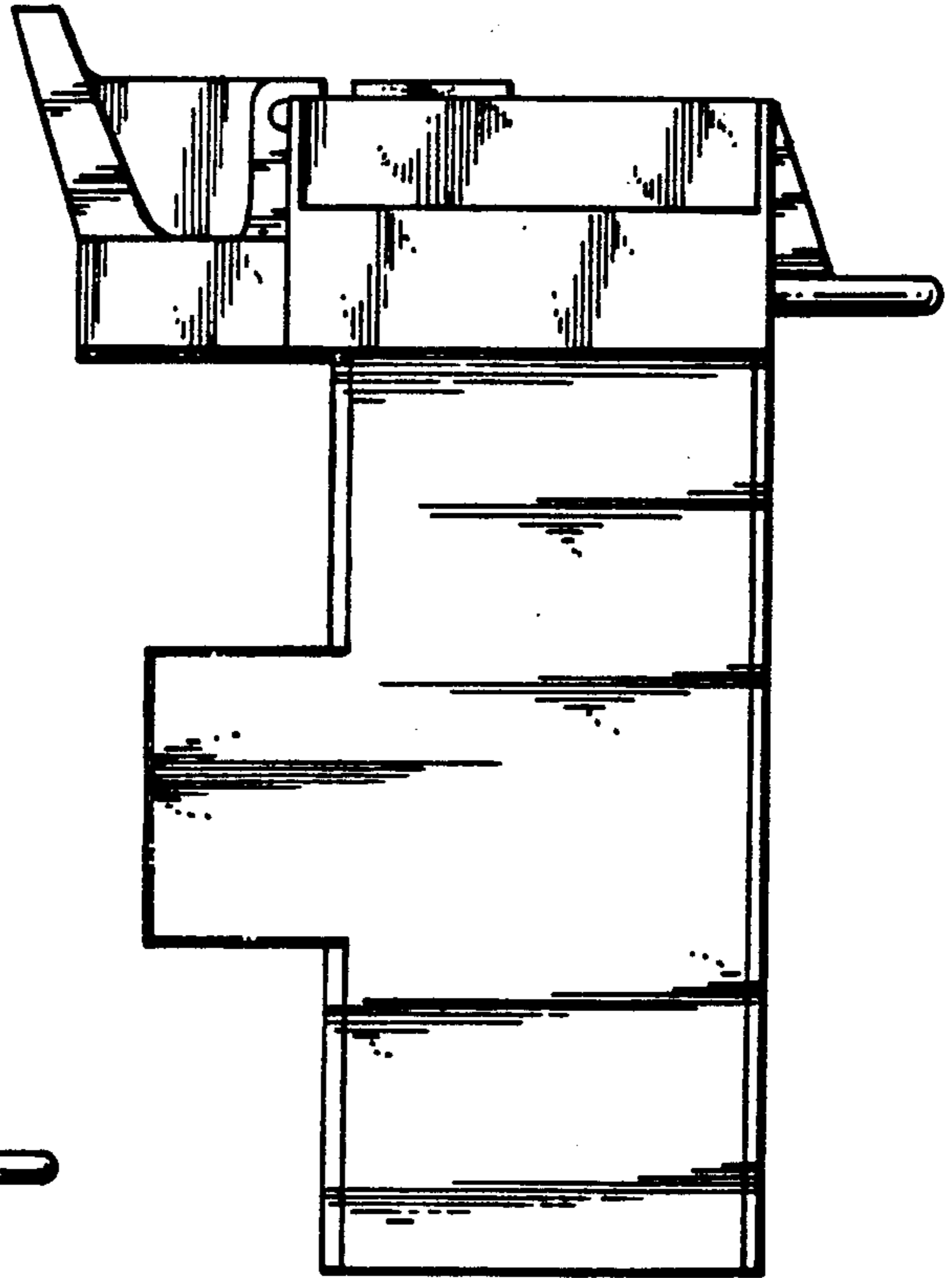

FIG. 7

FIG. 8

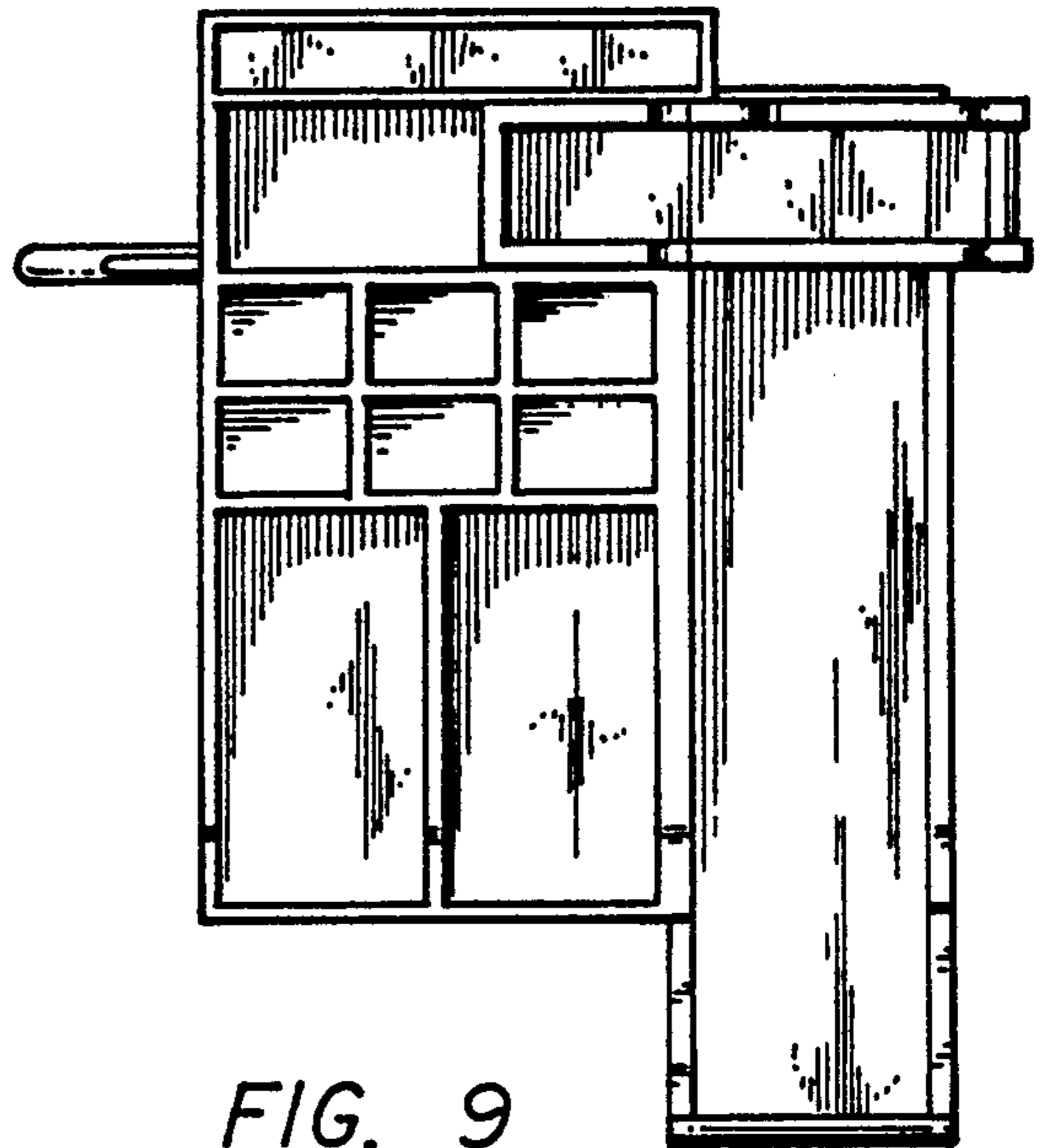
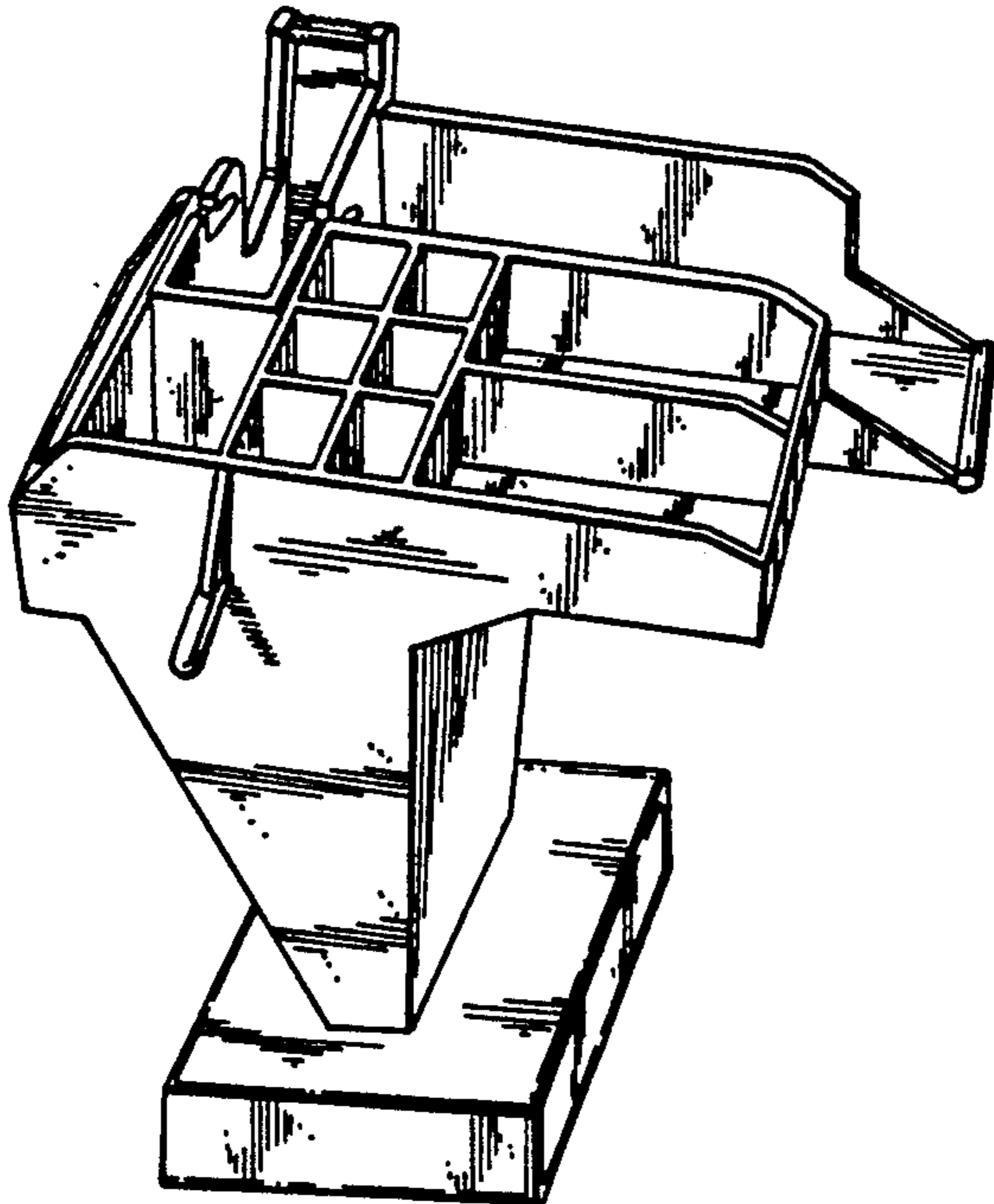

FIG. 9

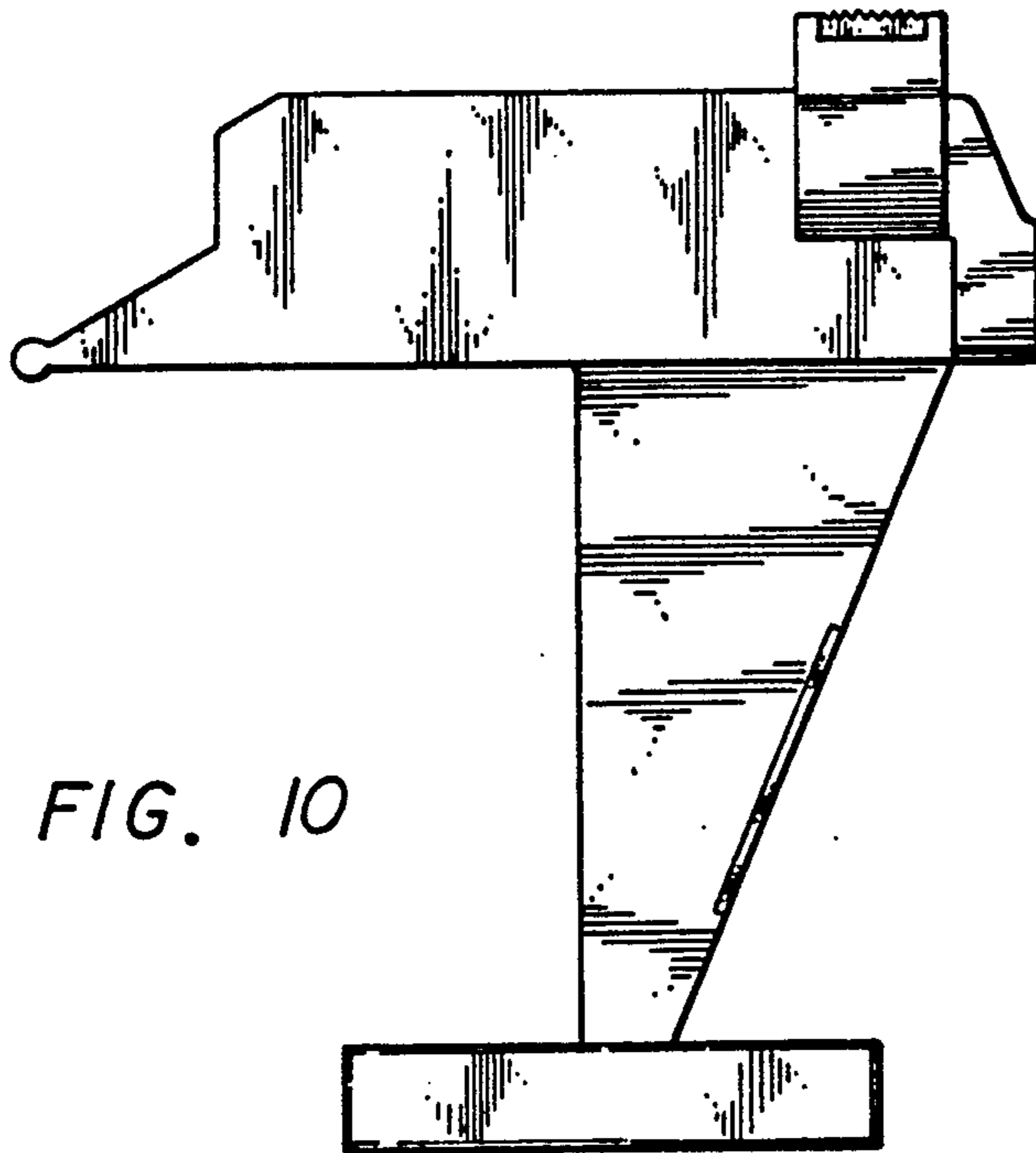

FIG. 10

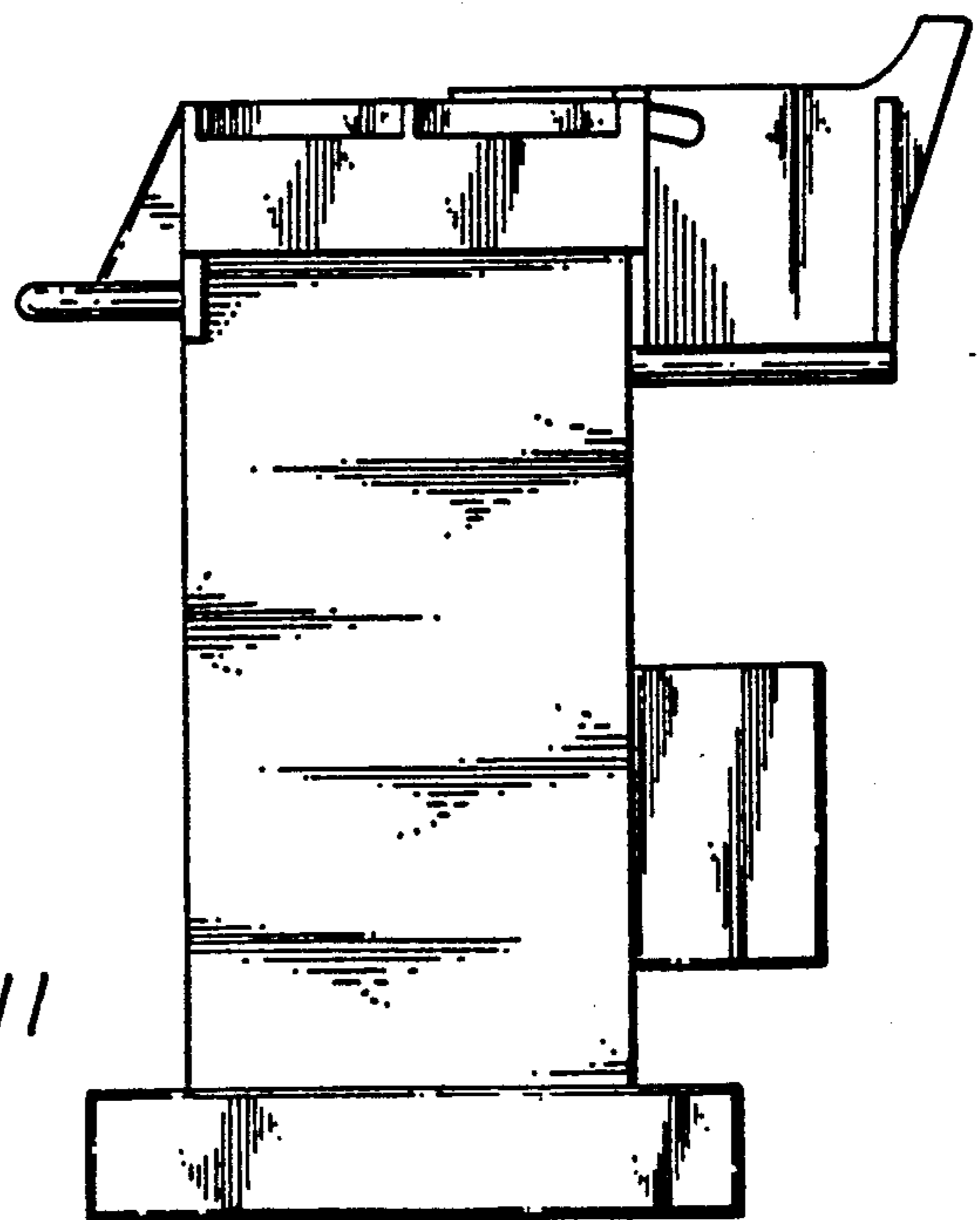

FIG. 11

FIG. 12

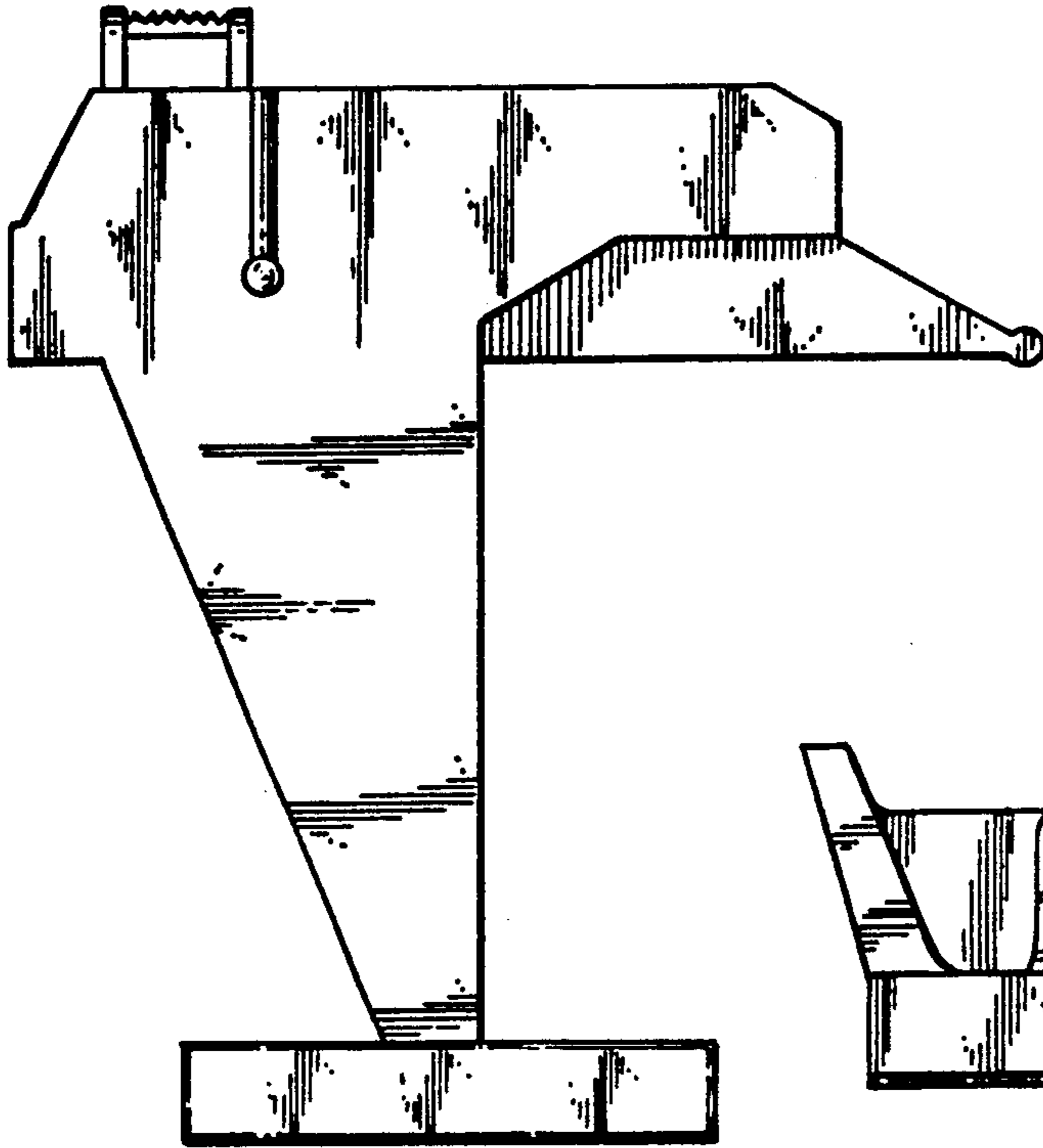

FIG. 13

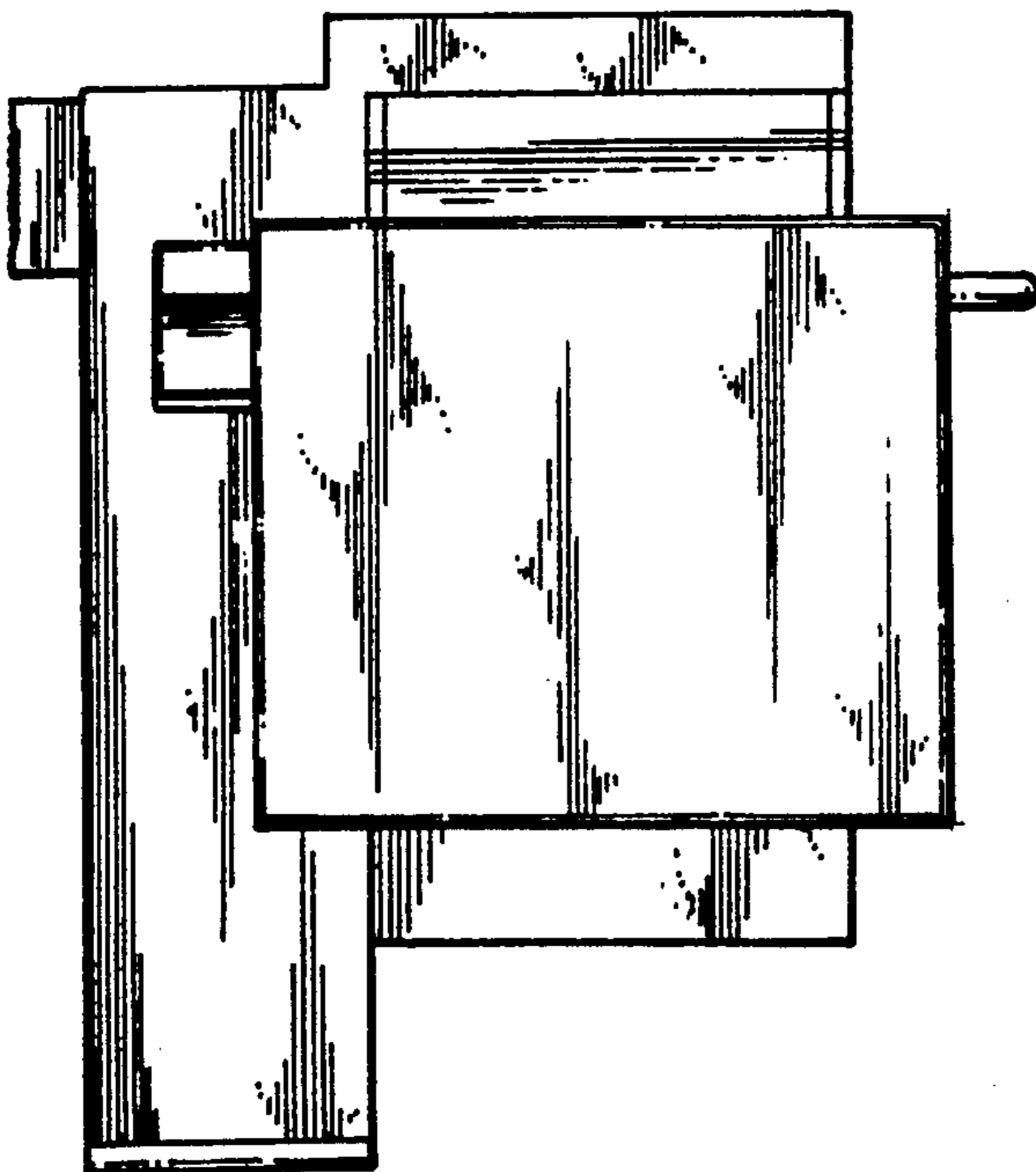
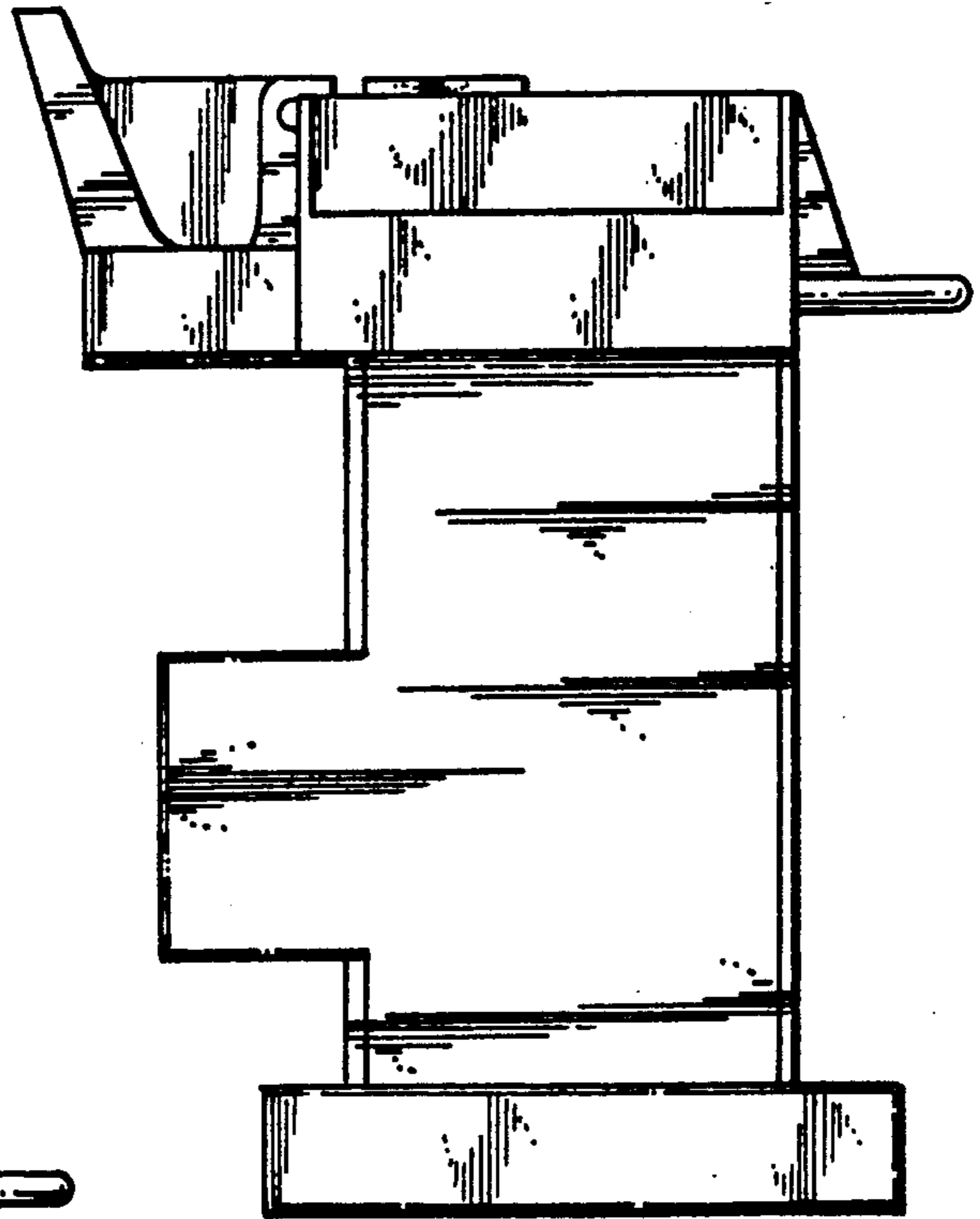

FIG. 14