

[54] **WATERCRAFT**

[75] **Inventor: Jack Sutherland, Springfield, Mo.**

[73] **Assignee: Dynamic Products, Inc., Springfield, Mo.**

[**] **Term: 14 Years**

[21] **Appl. No.: 429,352**

[22] **Filed: Oct. 31, 1989**

[52] **U.S. Cl. D12/318; D12/307**

[58] **Field of Search D12/300, 314, 318, 307;
114/270, 56, 291**

[56] **References Cited**

U.S. PATENT DOCUMENTS

D. 216,343 12/1969 Lapointe D12/318
D. 221,190 7/1971 Bonneson D12/314

OTHER PUBLICATIONS

"Aquapro", Make Waves, brochure for Fastrac 500, 600; 1987; 4 pages.

"Aquapro", It's No Toy, It's Fastrac brochure, 1988, 2 pages.

Primary Examiner—Kay H. Chin
Attorney, Agent, or Firm—Nixon & Vanderhye

[57] **CLAIM**

The ornamental design for a watercraft, as shown and described.

DESCRIPTION

FIG. 1 is a right side elevational view of a watercraft showing my new design, the left side view being a mirror image of that shown;

FIG. 2 is a front elevational view thereof;

FIG. 3 is a rear elevational view thereof;

FIG. 4 is a top plan view thereof;

FIG. 5 is a bottom plan view thereof;

FIG. 6 is a top perspective view; and

FIG. 7 is a bottom perspective view.

The broken lines shown in FIGS. 1 through 4, 6, and 7 are for illustrative purposes only and form no part of the claimed design.

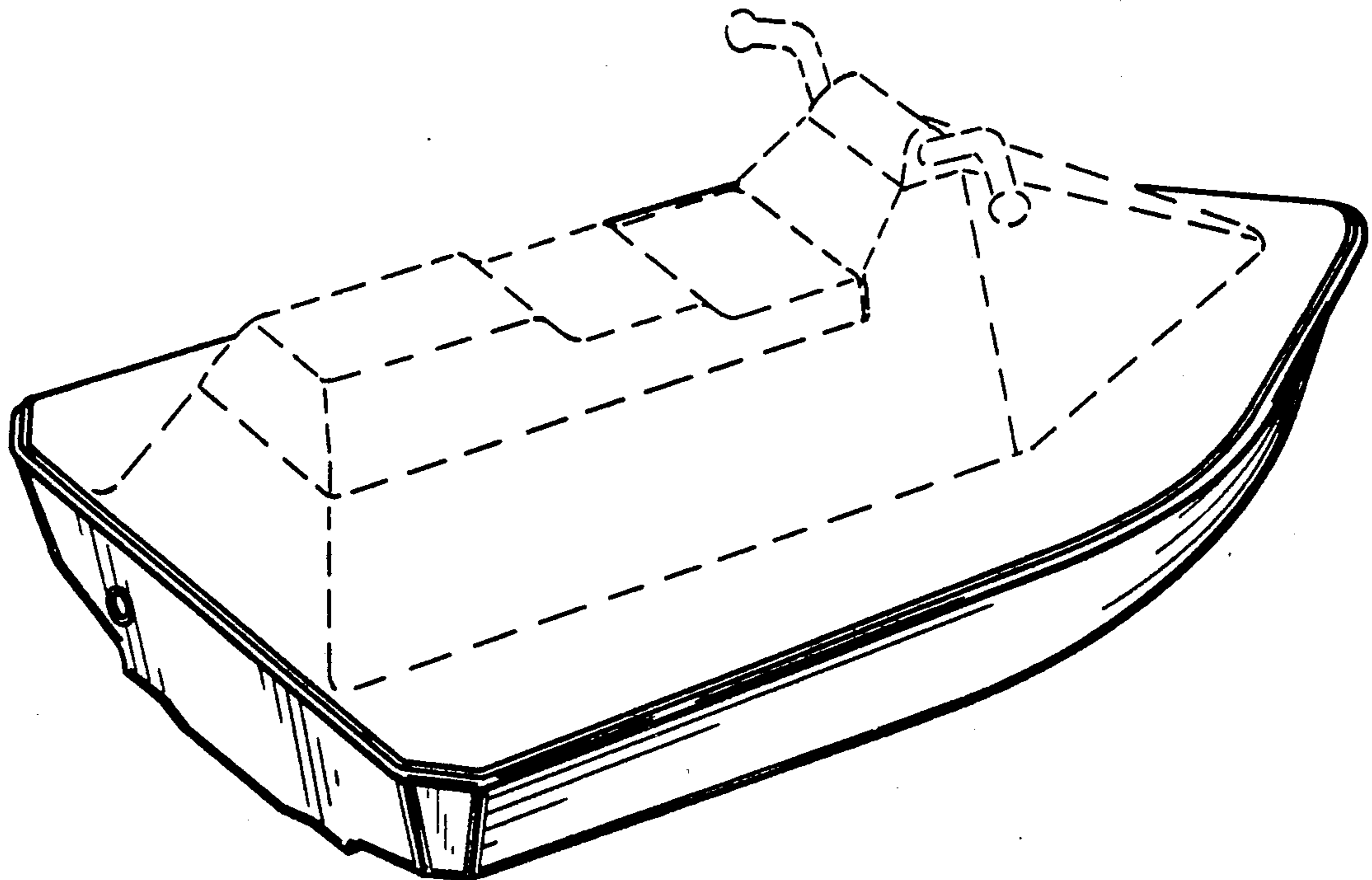

FIG. 1

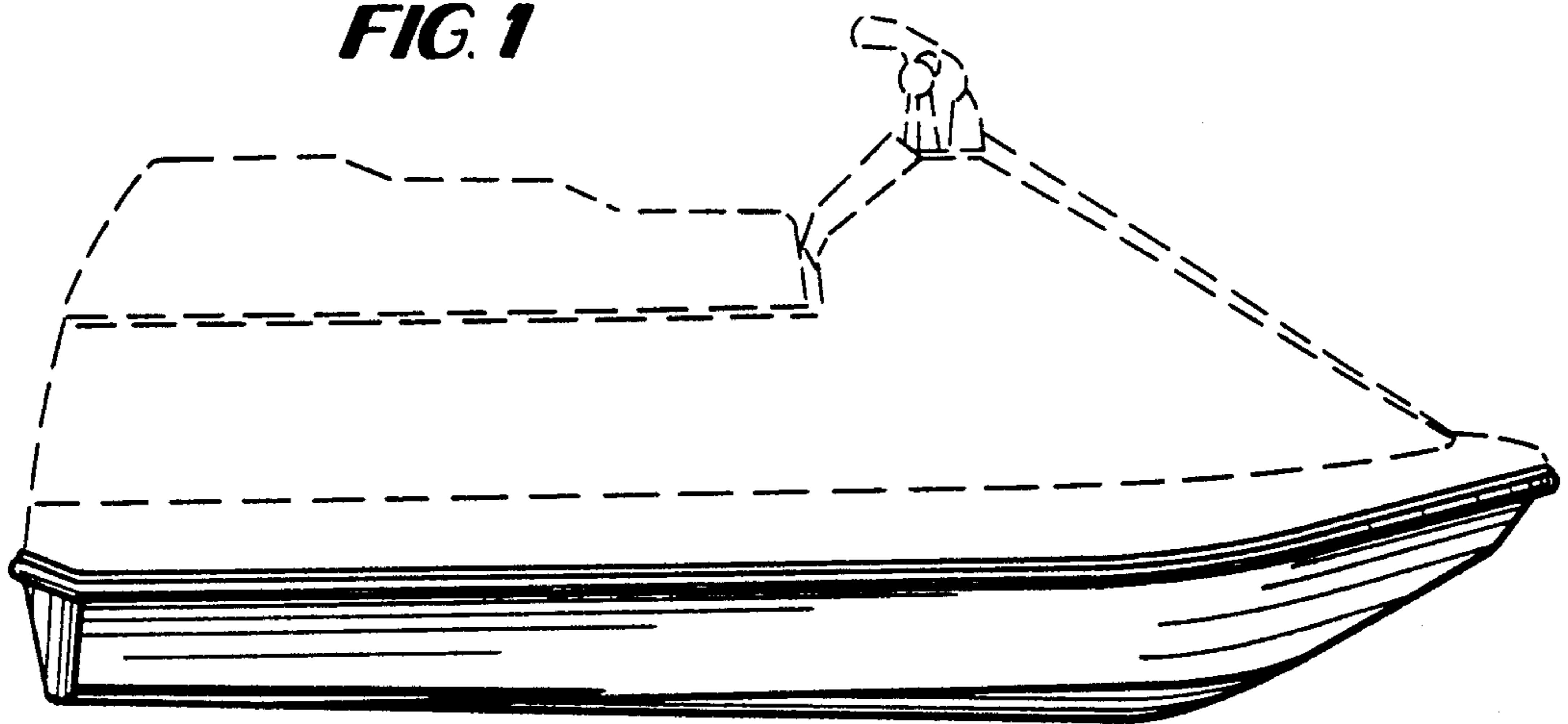

FIG. 2

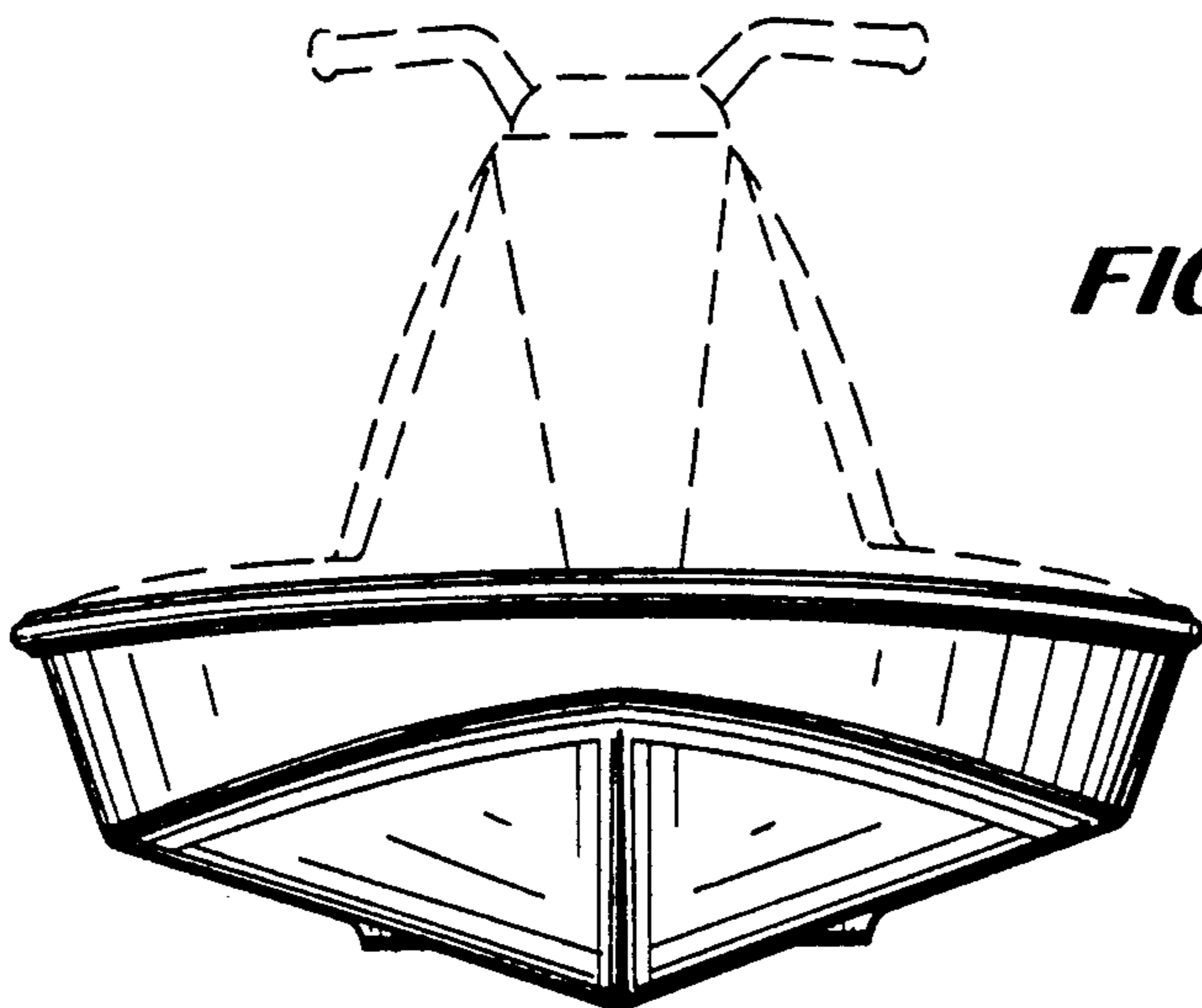

FIG. 3

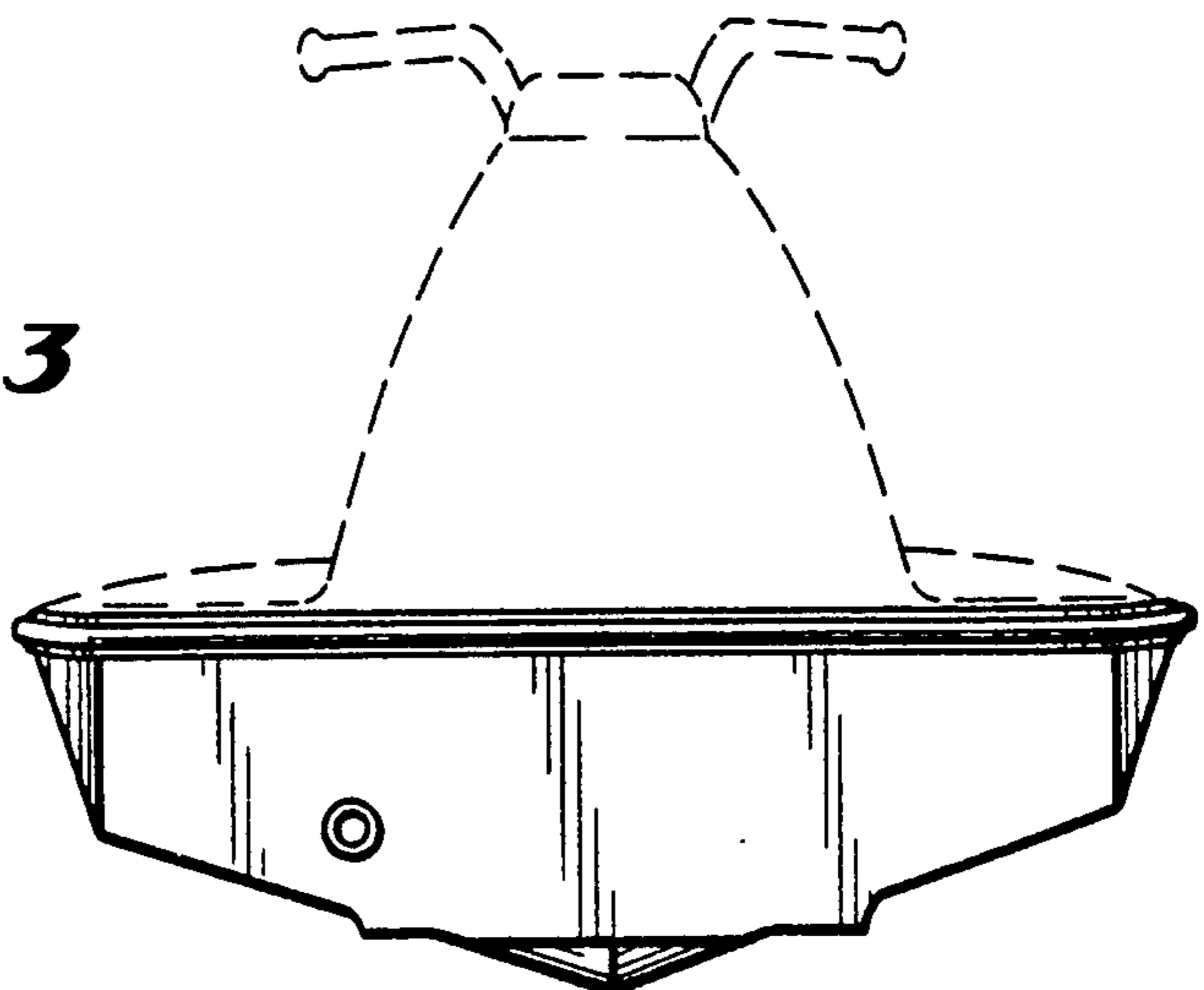

FIG. 4

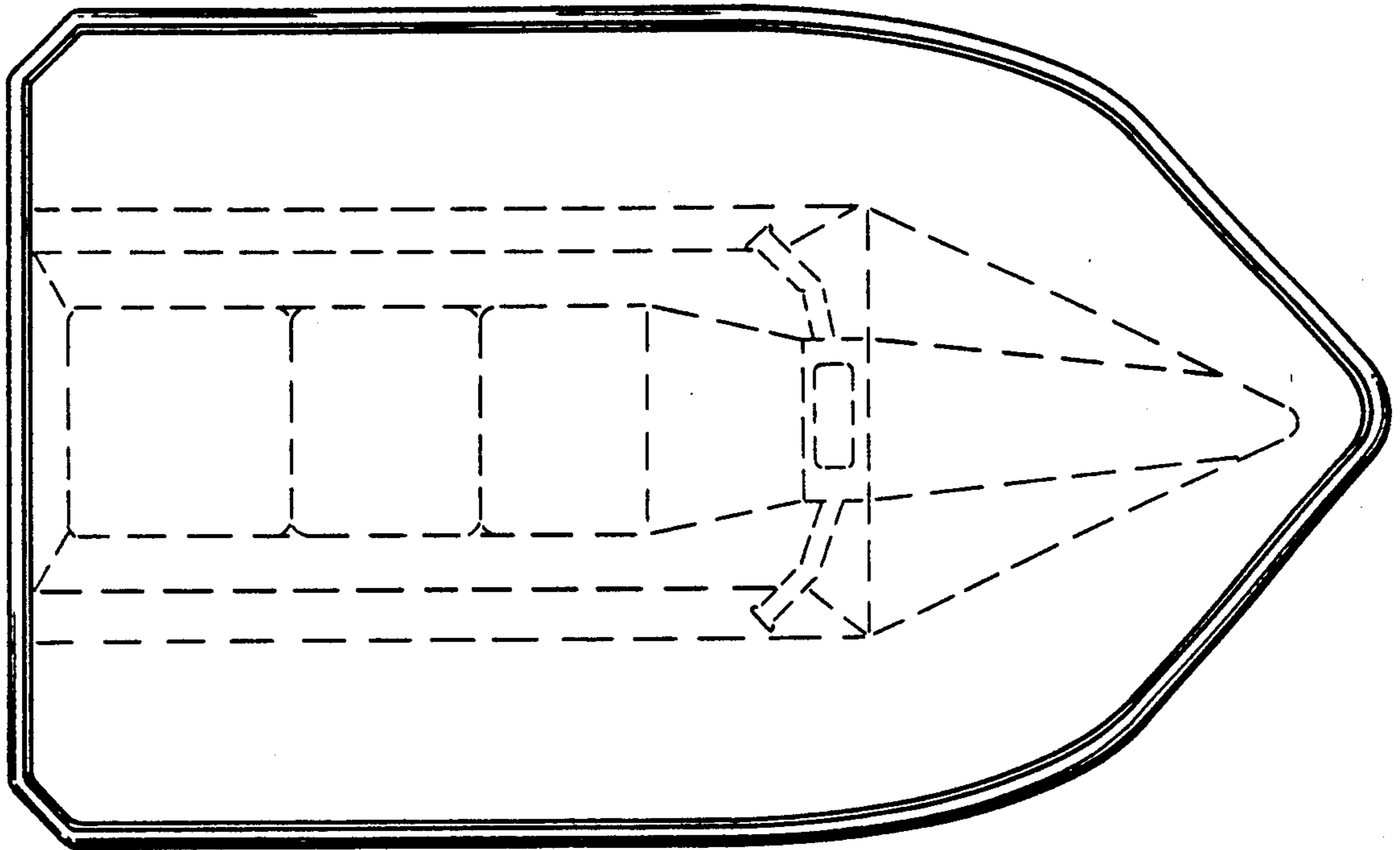
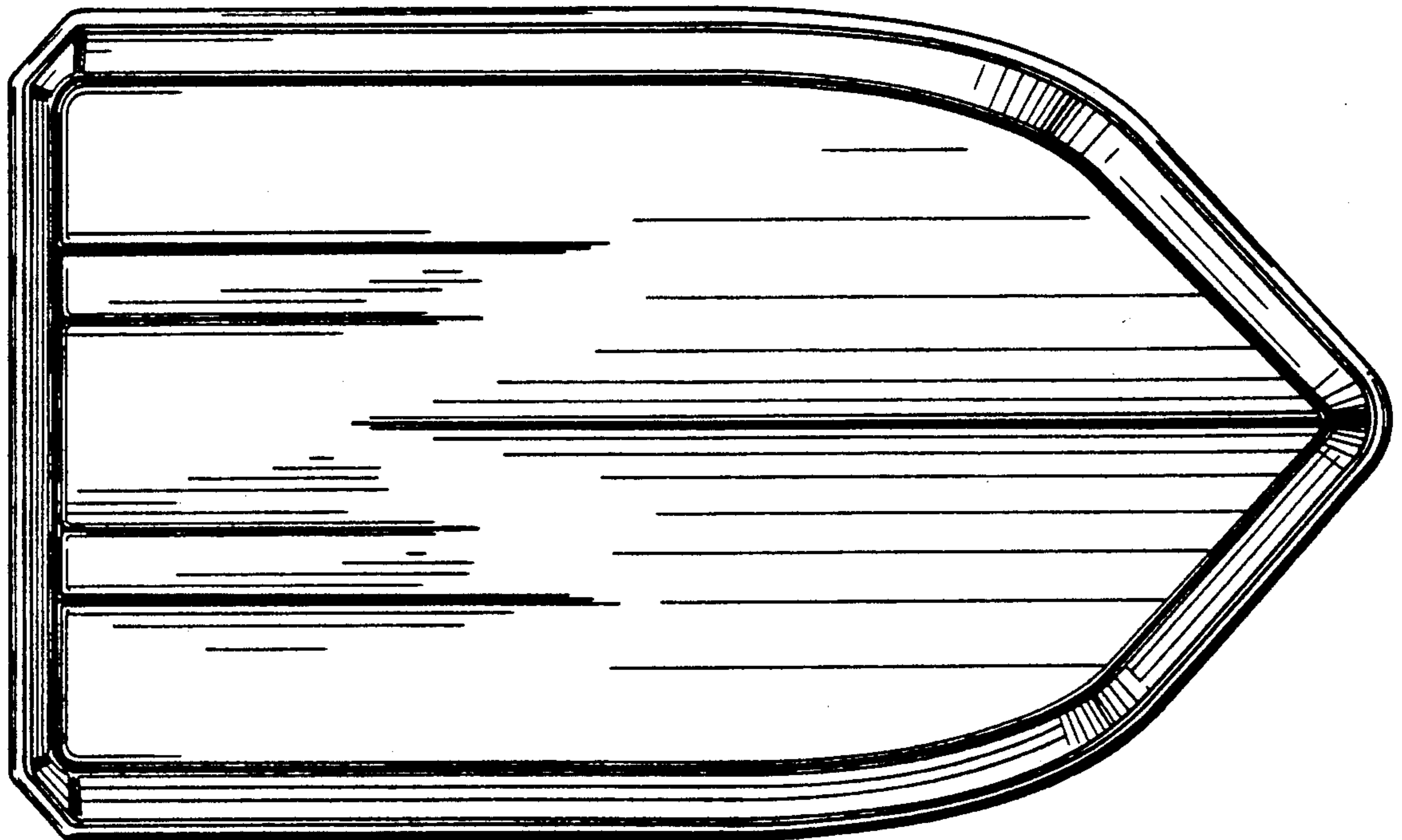

FIG. 5



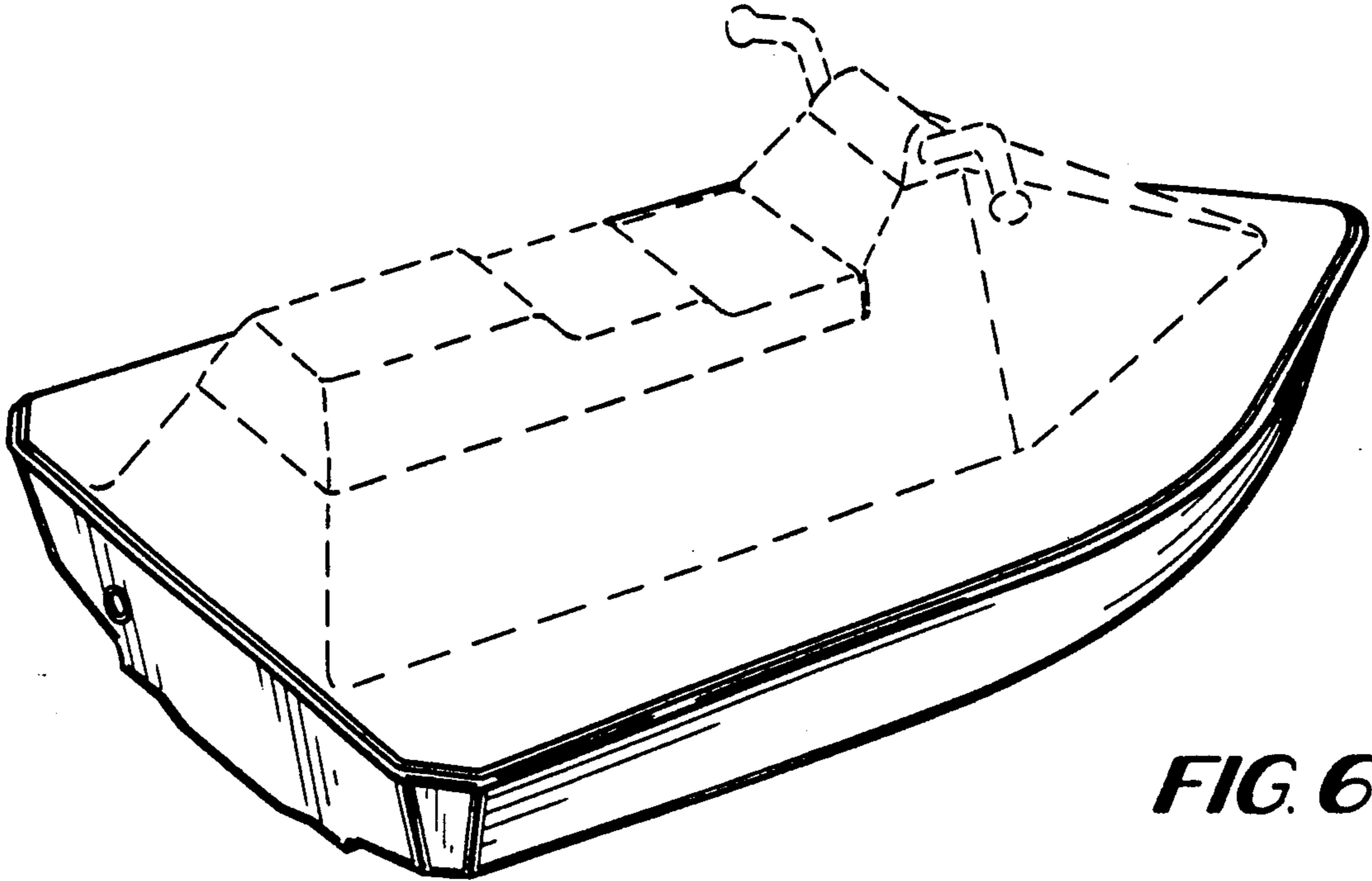

FIG. 6

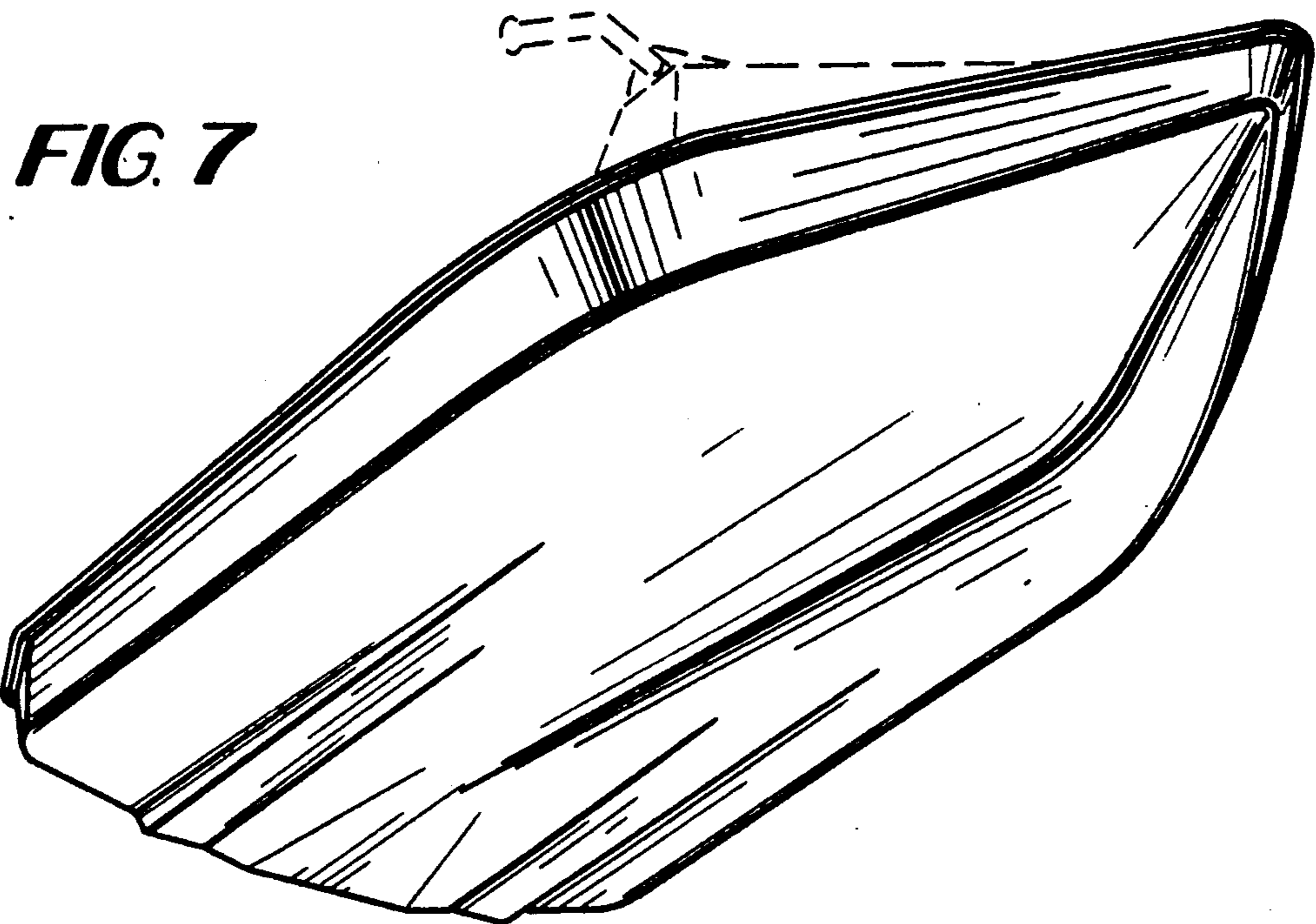

FIG. 7