

[54] FOREGRIP FOR A FISHING ROD

[75] Inventors: Casey J. Childre; George V. Walker; Michael Speh, all of Foley, Ala.

[73] Assignee: Lew Childre & Sons, Inc., Foley, Ala.

[**] Term: 14 Years

[21] Appl. No.: 209,534

[22] Filed: Jun. 21, 1988

[52] U.S. Cl. D22/142

[58] Field of Search D22/142, 137, 138; 43/21.2, 20, 22, 23

[56] References Cited

U.S. PATENT DOCUMENTS

D. 290,154	6/1987	Ohmura	D22/142
D. 295,211	4/1988	Moody	D22/142
4,648,195	3/1987	Kim	43/20
4,697,377	10/1987	Martin	43/23

Primary Examiner—A. Hugo Word
Assistant Examiner—Doris V. Coles
Attorney, Agent, or Firm—Lockwood, Alex, FitzGibbon & Cummings

[57] CLAIM

The ornamental design for a foregrip for a fishing rod, as shown and described.

DESCRIPTION

FIG. 1 is a side elevational view of a foregrip for a fishing rod, showing our new design;
FIG. 2 is a perspective view of a foregrip for a fishing rod showing our new design;
FIG. 3 is a rear elevational view thereof;
FIG. 4 is a side elevational view thereof;
FIG. 5 is a front elevational view thereof;
FIG. 6 is a top plan view thereof;
FIG. 7 is a bottom plan view thereof.
The broken line showing of the rod, reel, and hand is for illustrative purposes only and forms no part of the claimed design.

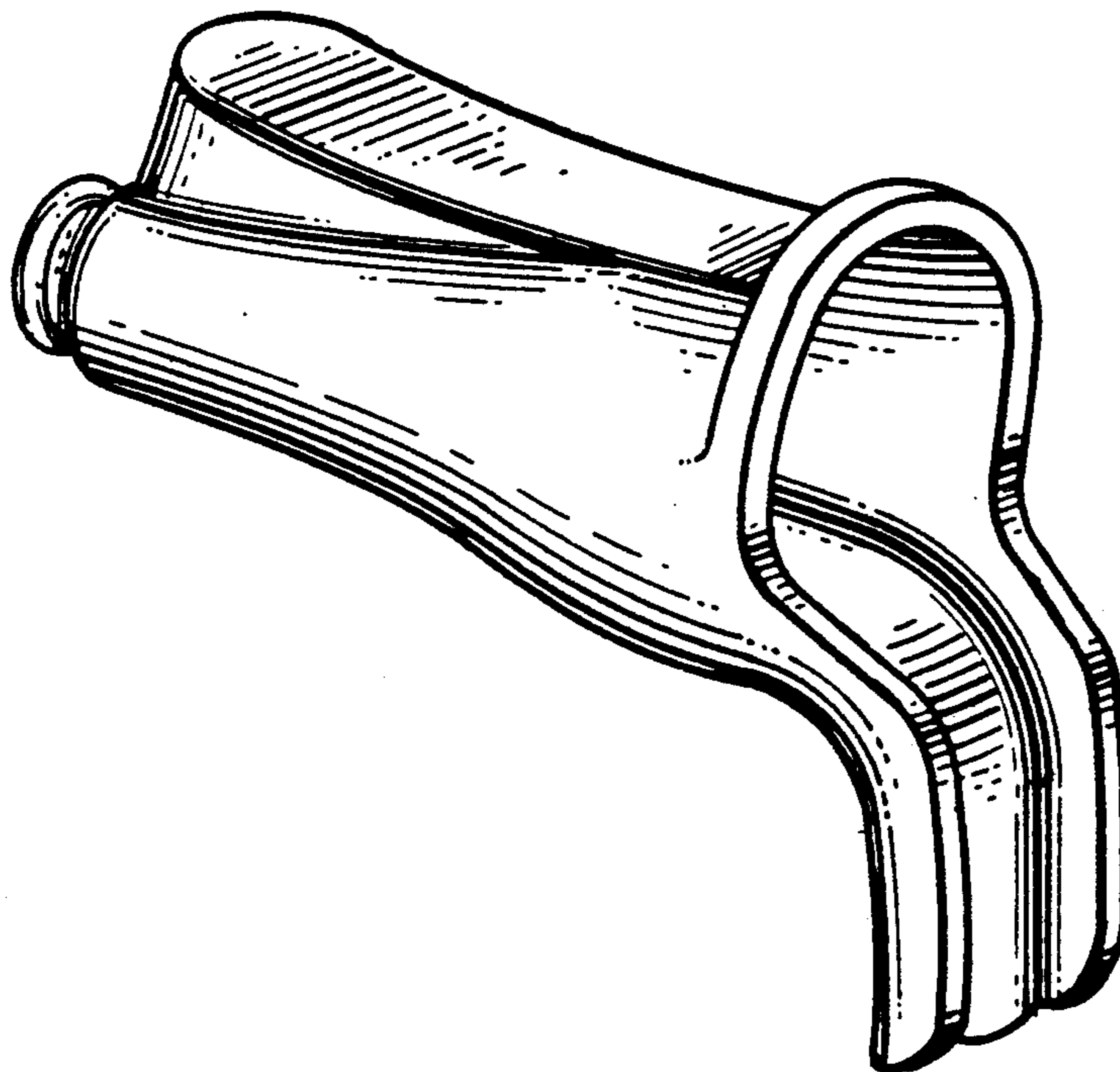

FIG. 1

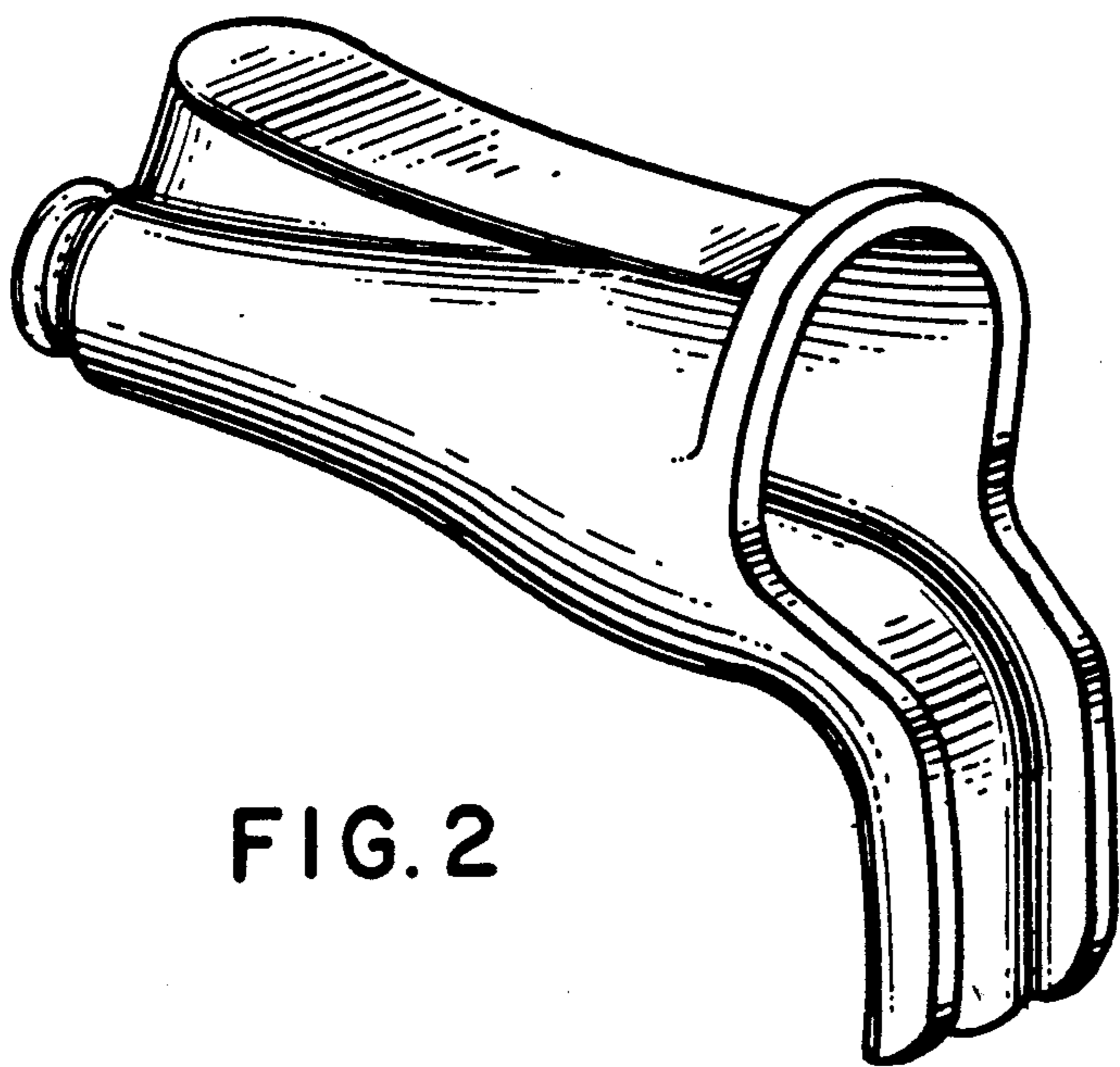
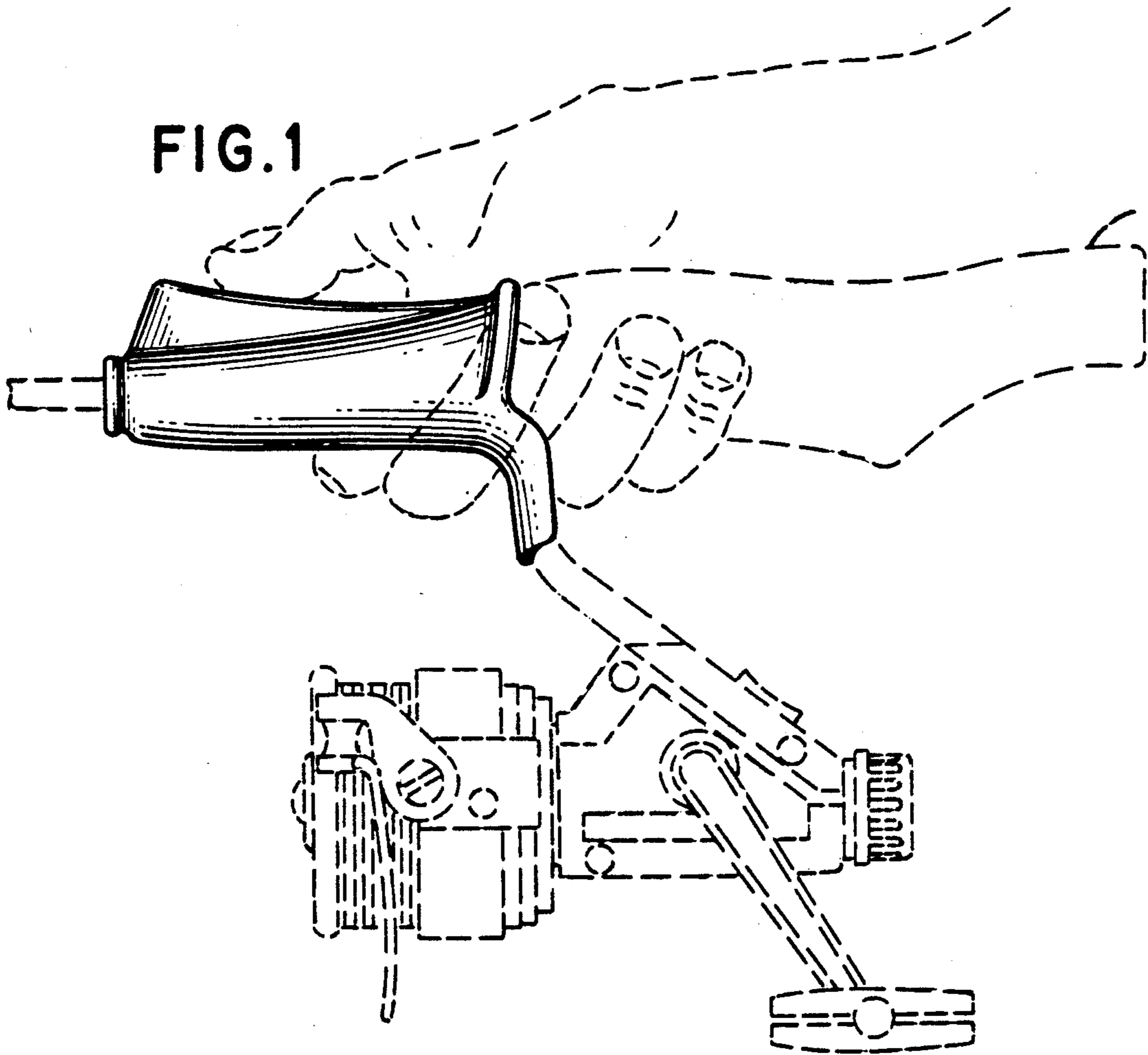

FIG. 2

FIG. 3

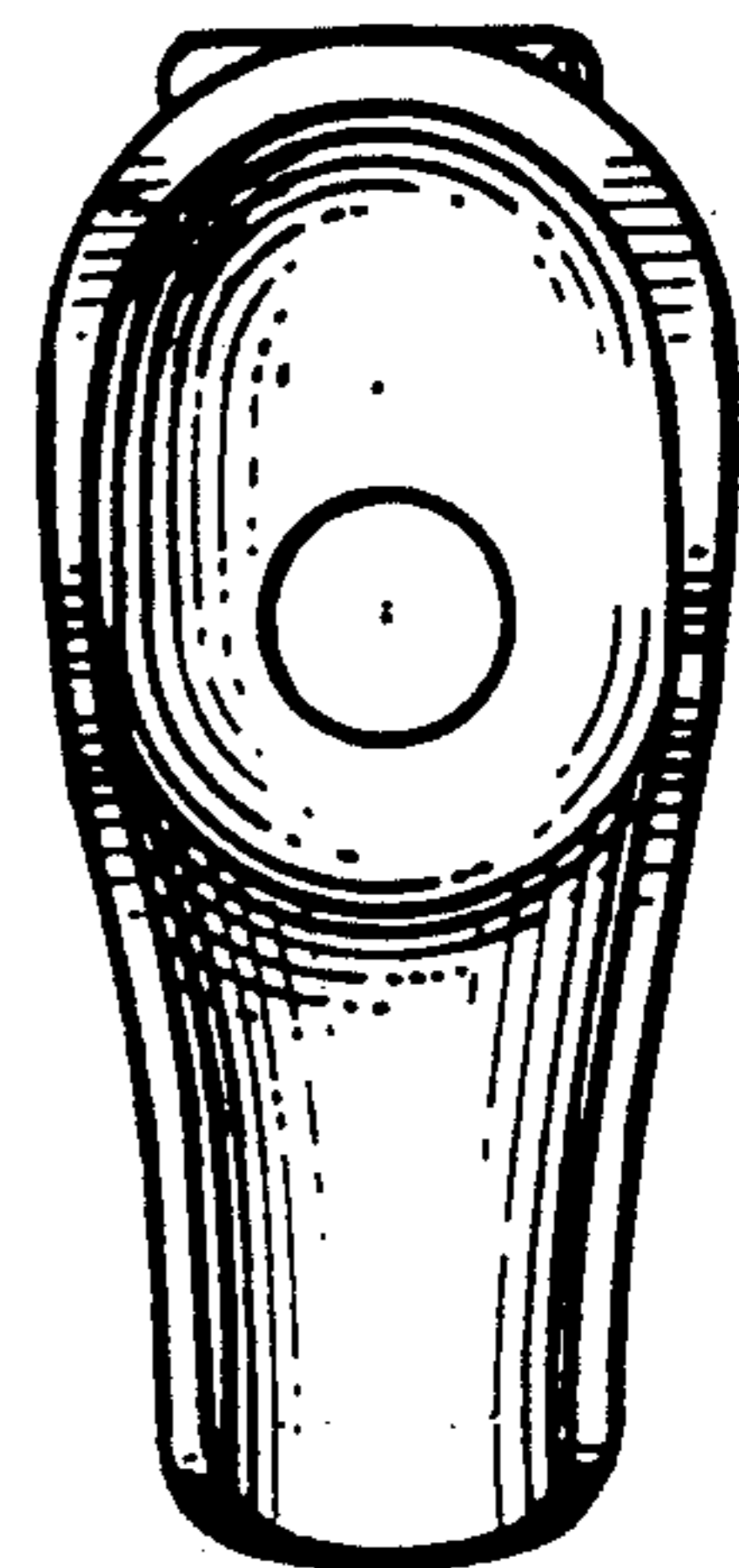

FIG. 4

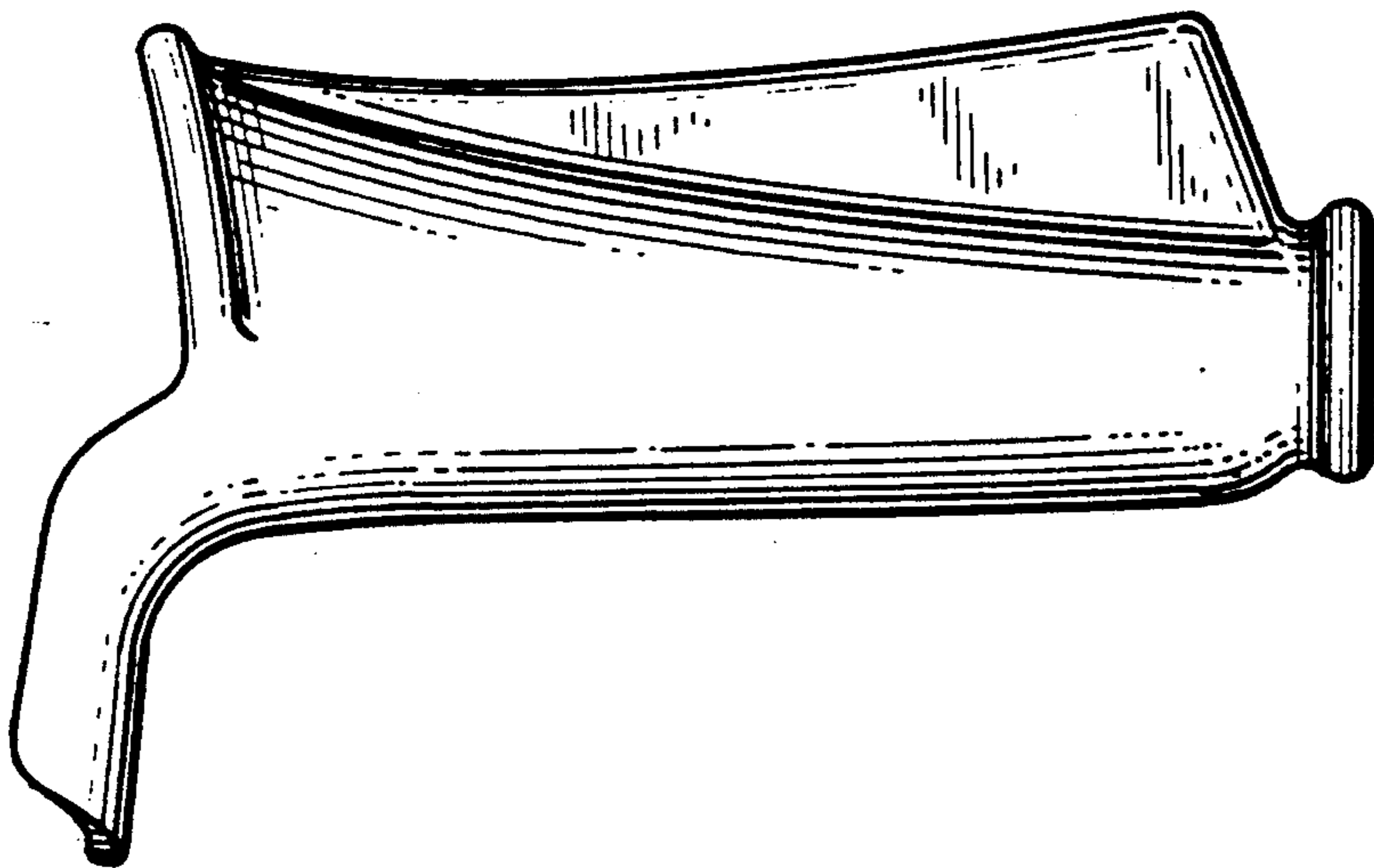

FIG. 5

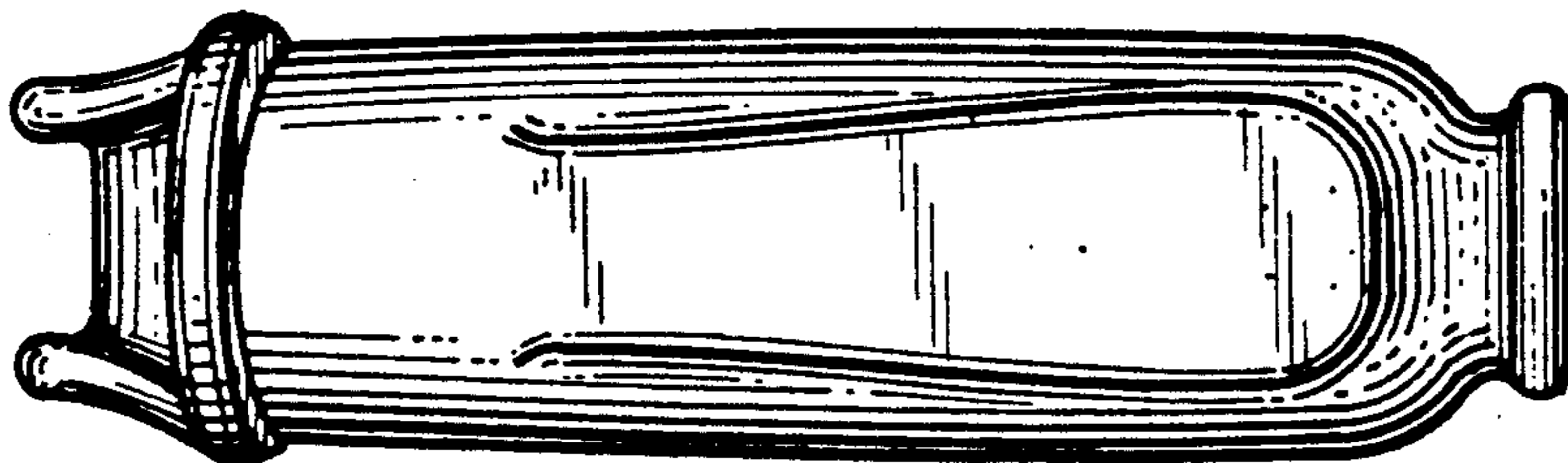
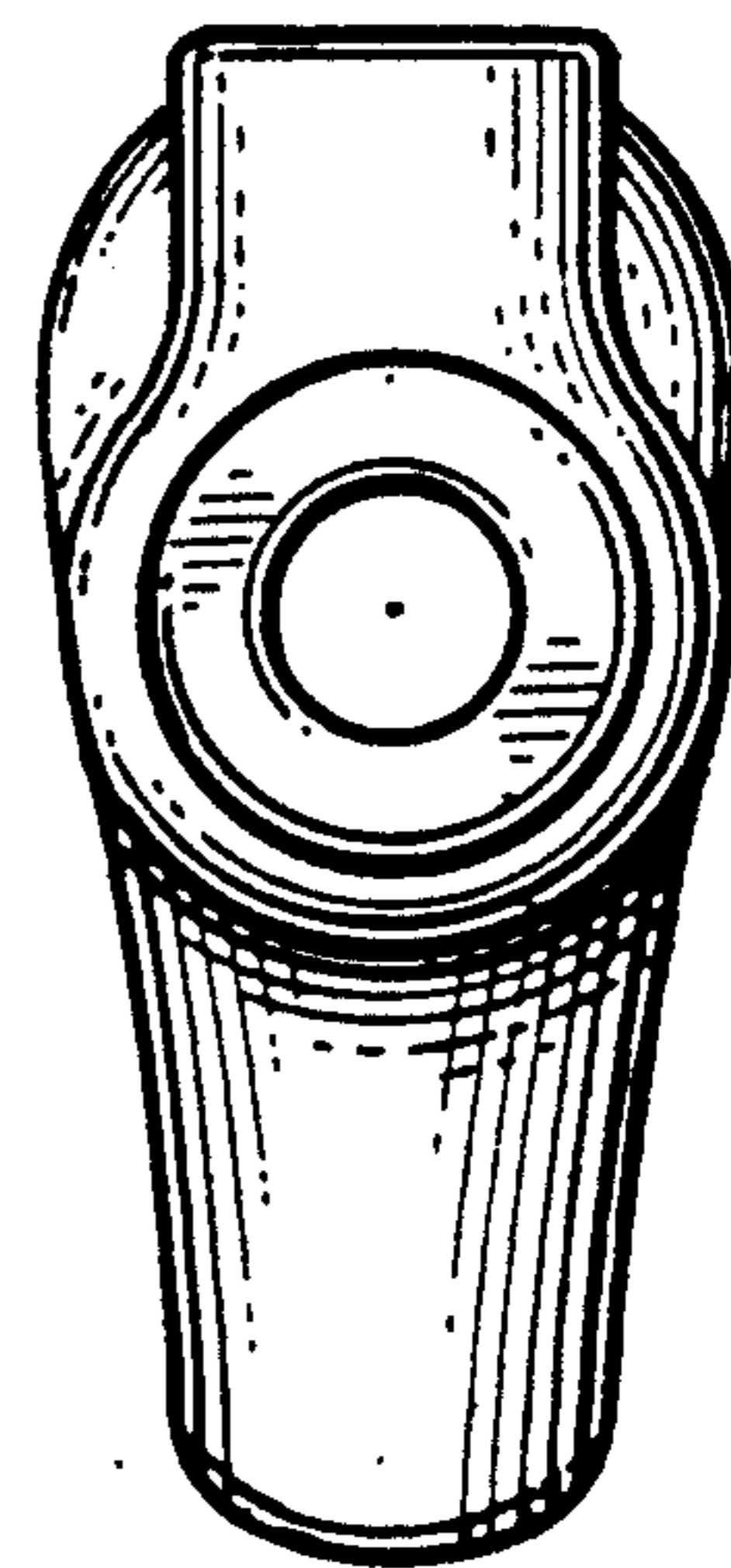

FIG. 6

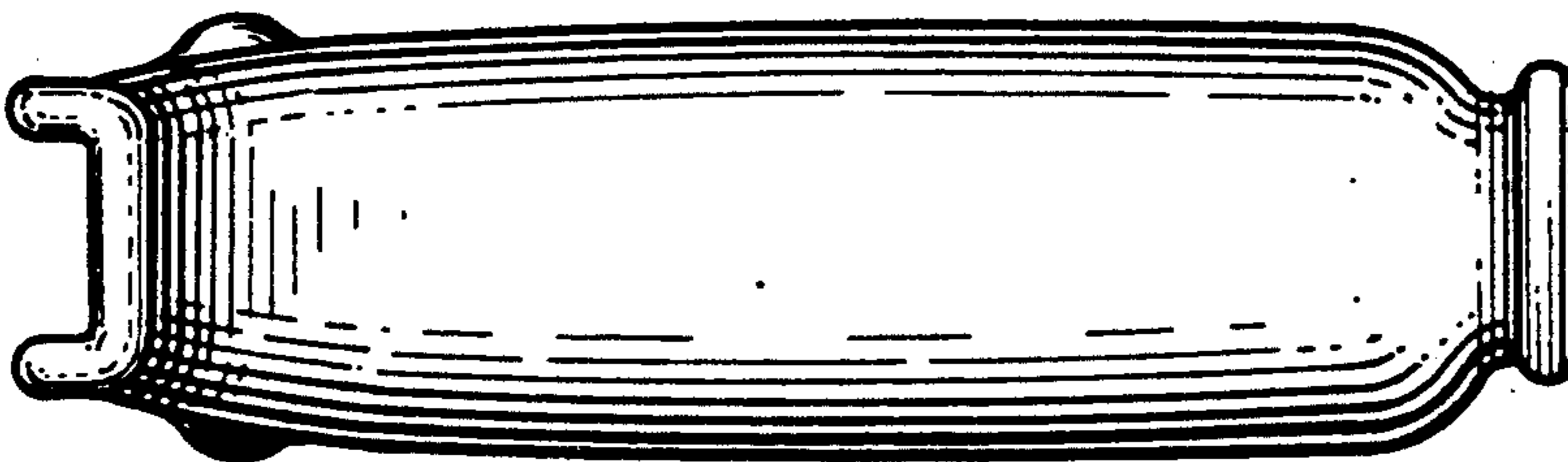

FIG. 7