

[54] MEMO PAPER TRAY

[75] Inventor: Heng G. Kheng, Singapore, Singapore

[73] Assignee: Metro Plastic Industry Pte. Ltd., Singapore, Singapore

[**] Term: 14 Years

[21] Appl. No.: 201,621

[22] Filed: Jun. 2, 1988

[52] U.S. Cl. D19/92; D19/75; D19/86

[58] Field of Search D19/65, 75, 78, 86, D19/92, 95, 99, 100; 206/215, 555; 211/11, 50, 45

[56] References Cited

U.S. PATENT DOCUMENTS

- D. 139,095 10/1944 Greenstein D19/92 X
- D. 176,366 12/1955 McFadyen D19/78
- D. 200,370 2/1965 Sherman D19/92
- D. 201,732 7/1965 Bunn et al. D19/92

- D. 226,241 1/1973 Zelenko D19/92
- D. 228,083 8/1973 Longarzo D19/86 X
- D. 257,778 1/1981 Macowski D19/92 X
- D. 263,724 4/1982 Laughlin D19/92
- D. 282,083 1/1986 Kier D19/92
- D. 298,441 11/1988 Bucher D19/92
- D. 303,397 9/1989 Heng D19/75

Primary Examiner—Bruce W. Dunkins
Assistant Examiner—Martha Thompson
Attorney, Agent, or Firm—Lee W. Tower

[57] CLAIM

The ornamental design for a memo paper tray, as shown and described.

DESCRIPTION

FIG. 1 is a top plan view of a memo paper tray showing my new design;
FIG. 2 is a bottom plan view;
FIG. 3 is a side elevational view, the opposite side being a mirror image thereof;
FIG. 4 is a rear elevational view;
FIG. 5 is a front elevational view; and
FIG. 6 is a perspective view thereof.

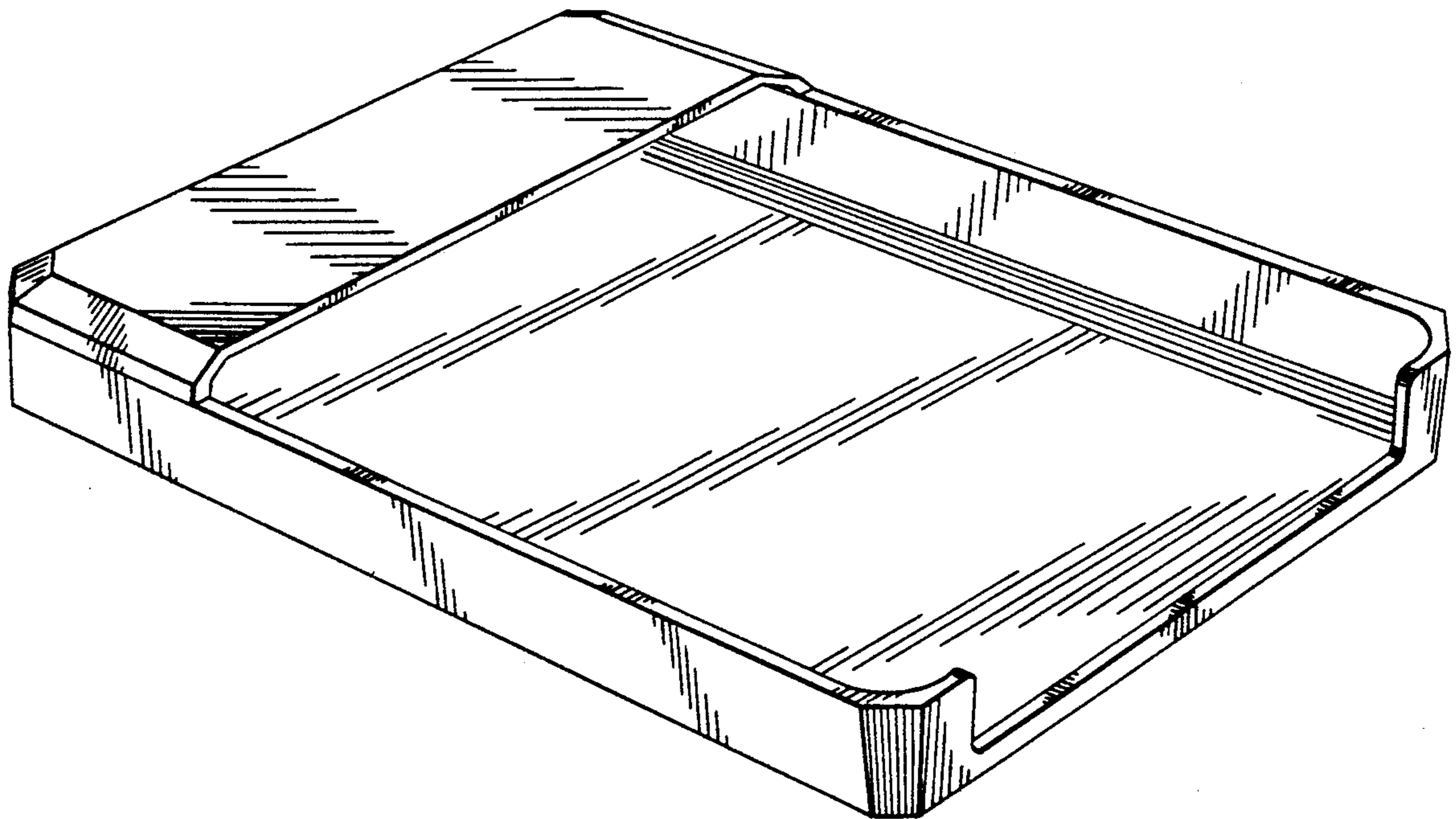

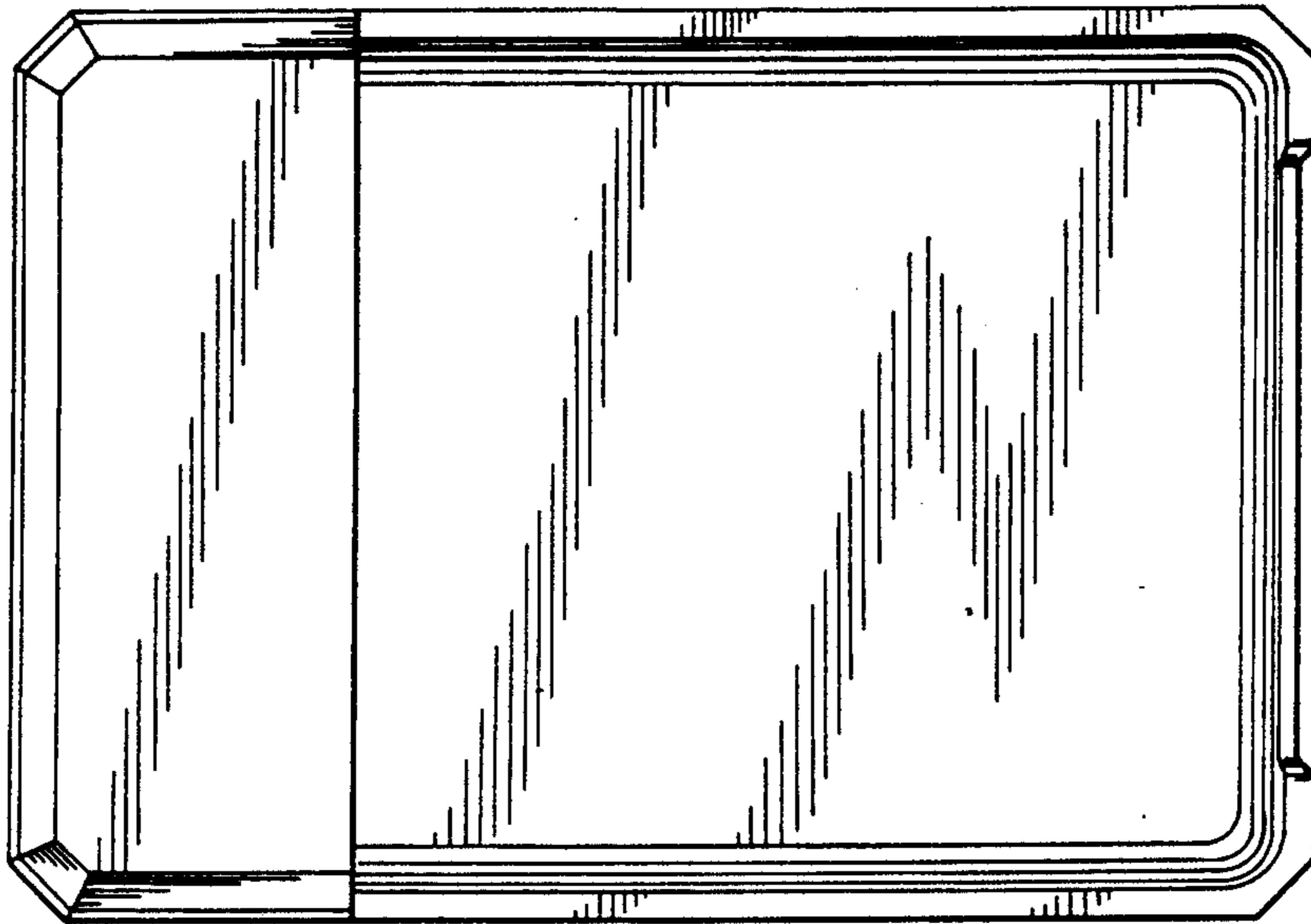

FIG. 1

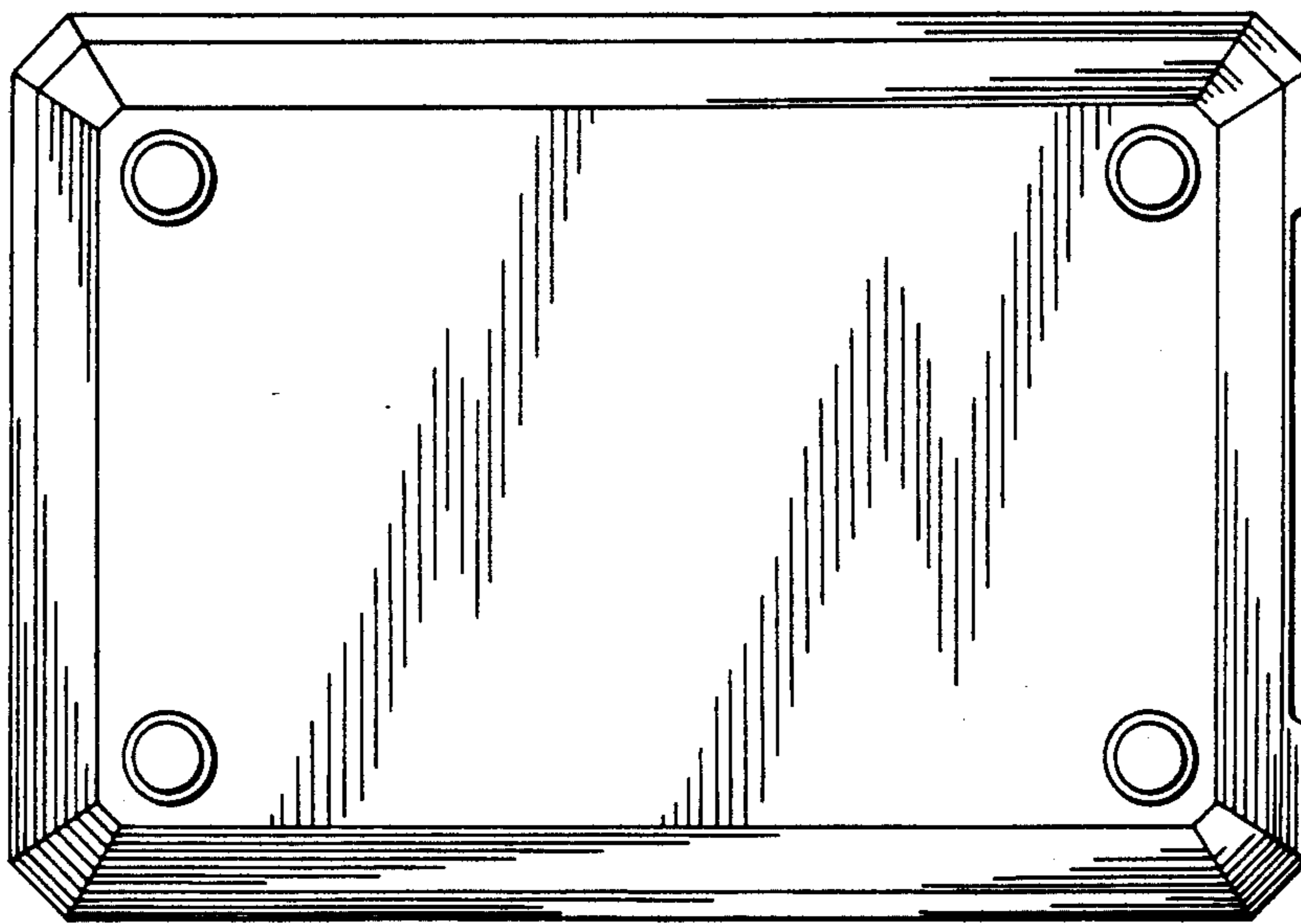

FIG. 2

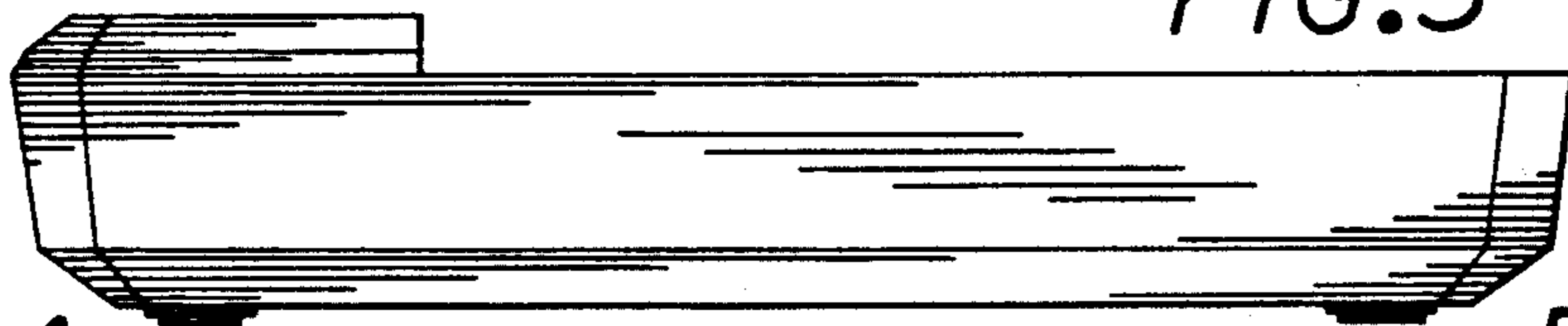

FIG. 3

FIG. 4

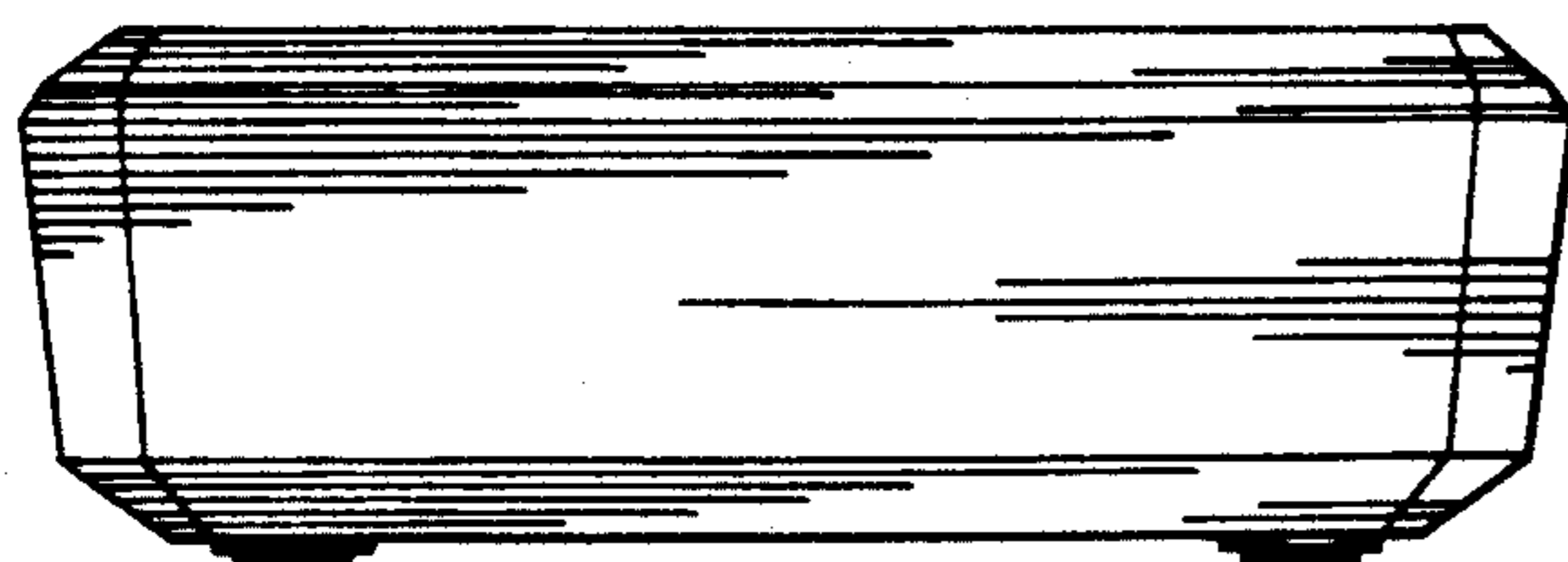
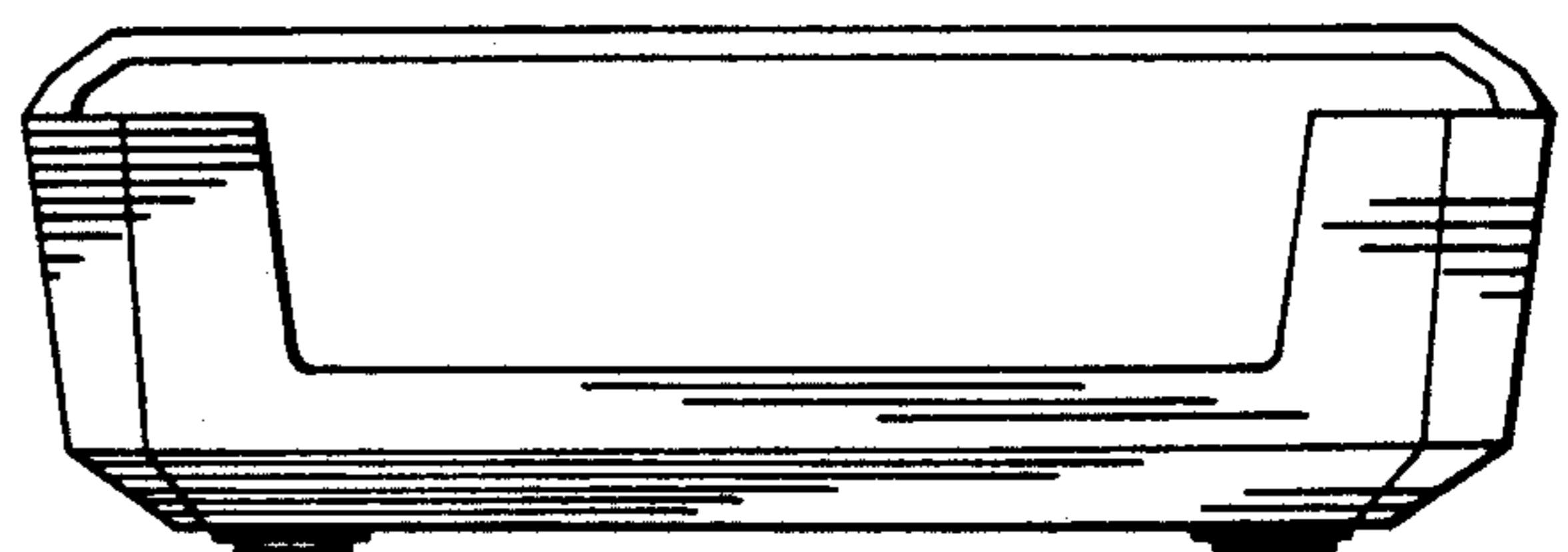

FIG. 5



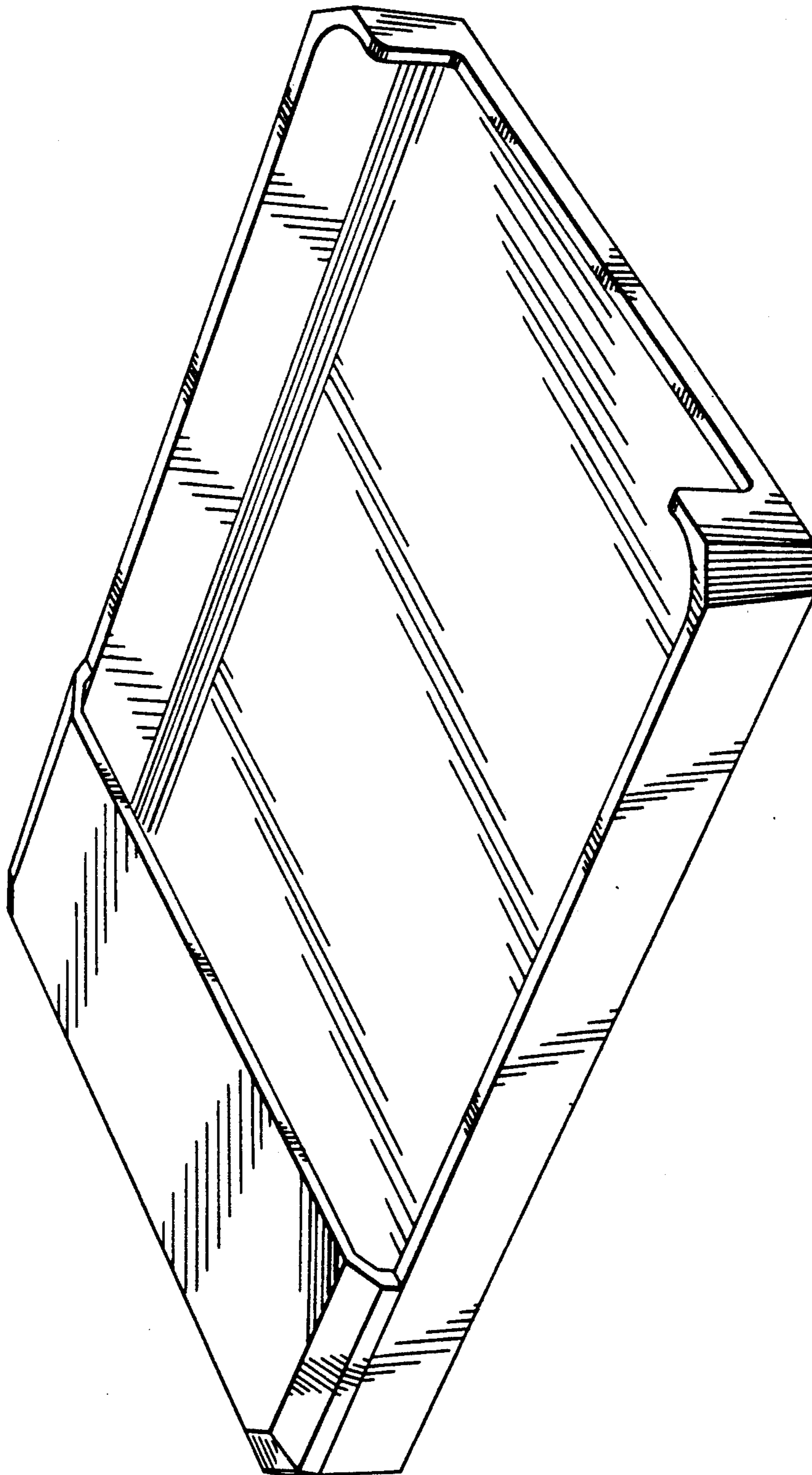

FIG. 6