

United States Patent [19]
Haffner

[11] **Patent Number: Des. 317,371**
[45] **Date of Patent: ** Jun. 4, 1991**

[54] **ANIMAL BATH TUB**
[76] **Inventor: Sally J. Haffner, 97 E. Endfield Rd., Feasterville, Pa. 19047**
[**] **Term: 14 Years**
[21] **Appl. No.: 120,513**
[22] **Filed: Nov. 13, 1987**
[52] **U.S. Cl. D30/158; D23/281**
[58] **Field of Search D30/118, 119, 120, 123, D30/199; D23/277-282, 289; 119/15, 19, 24; D99/29; D9/425, 431, 432; 4/588**

D. 251,202 2/1979 Charewicz D23/289
573,625 12/1896 Fuffner 4/588
2,030,687 2/1936 Davis D23/282

Primary Examiner—James R. Largen
Assistant Examiner—Cathy Anne MacCormac
Attorney, Agent, or Firm—John J. Simkanich

[56] **References Cited**
U.S. PATENT DOCUMENTS
D. 17,410 6/1887 Peet D23/282
D. 104,933 6/1937 Vaughn D23/281
D. 183,625 9/1958 Masso D99/29
D. 185,949 8/1959 Kiefer D23/289
D. 248,107 6/1978 Brengord et al. D23/279

[57] **CLAIM**
The ornamental design for an animal bath tub, as shown and described.

DESCRIPTION
FIG. 1 is a top, rear and left side perspective view of an animal bath tub showing my new design;
FIG. 2 is a left side elevational view thereof, the right side being a mirror image of the left side shown;
FIG. 3 is a front elevational view thereof;
FIG. 4 is a rear elevational view thereof;
FIG. 5 is a top plan view thereof; and
FIG. 6 is a bottom plan view thereof.

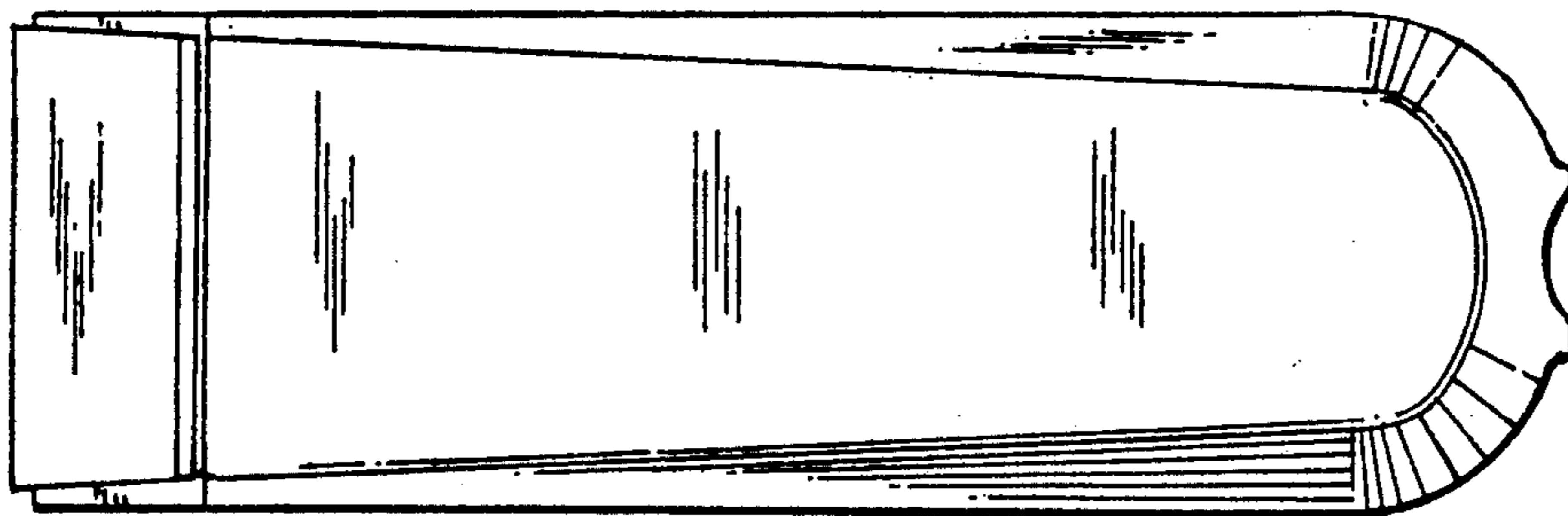

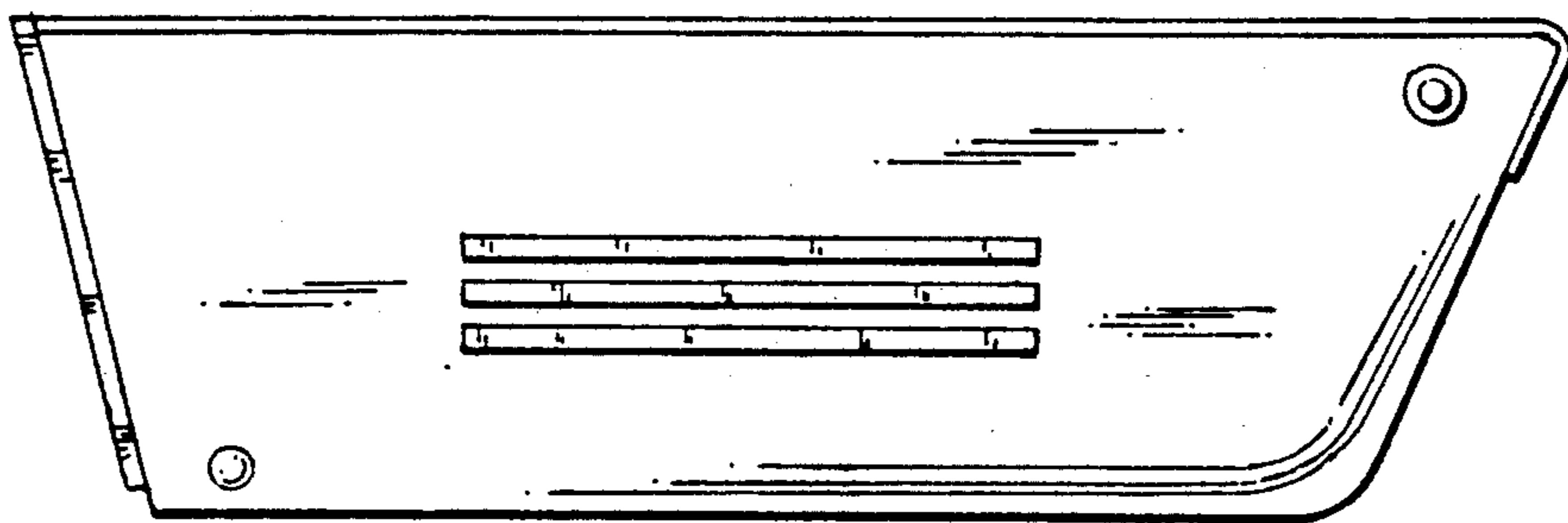
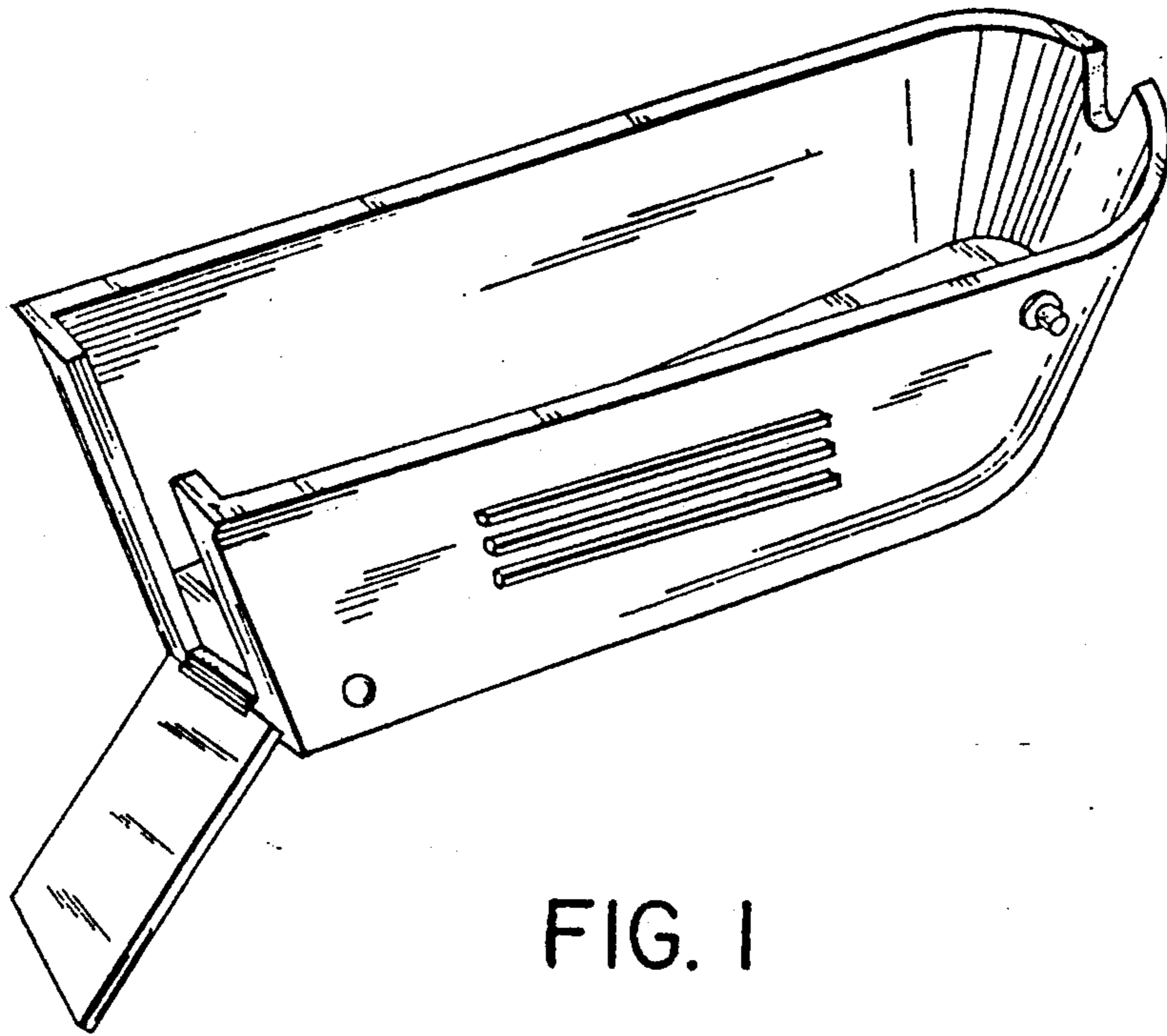

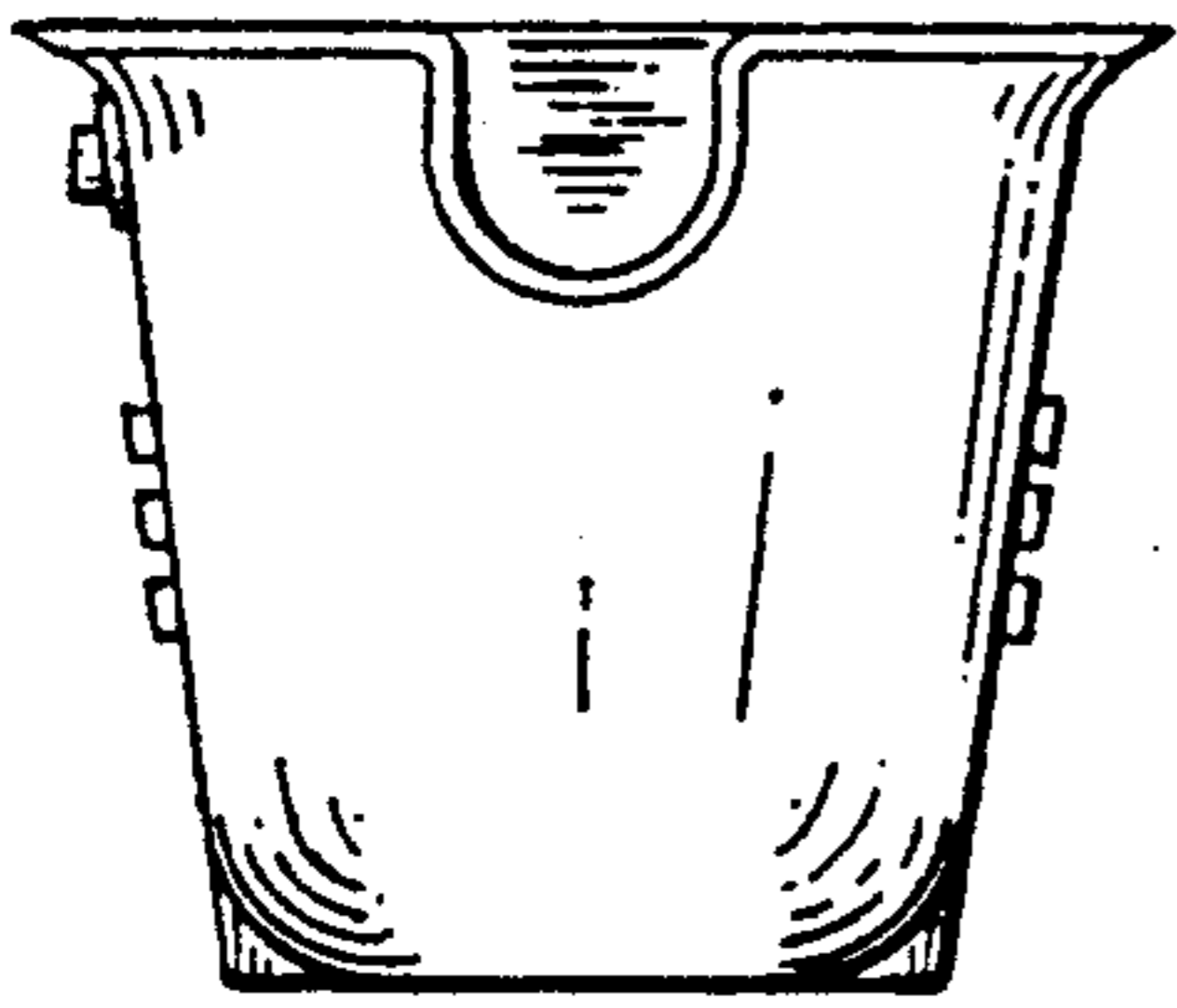

FIG. 3

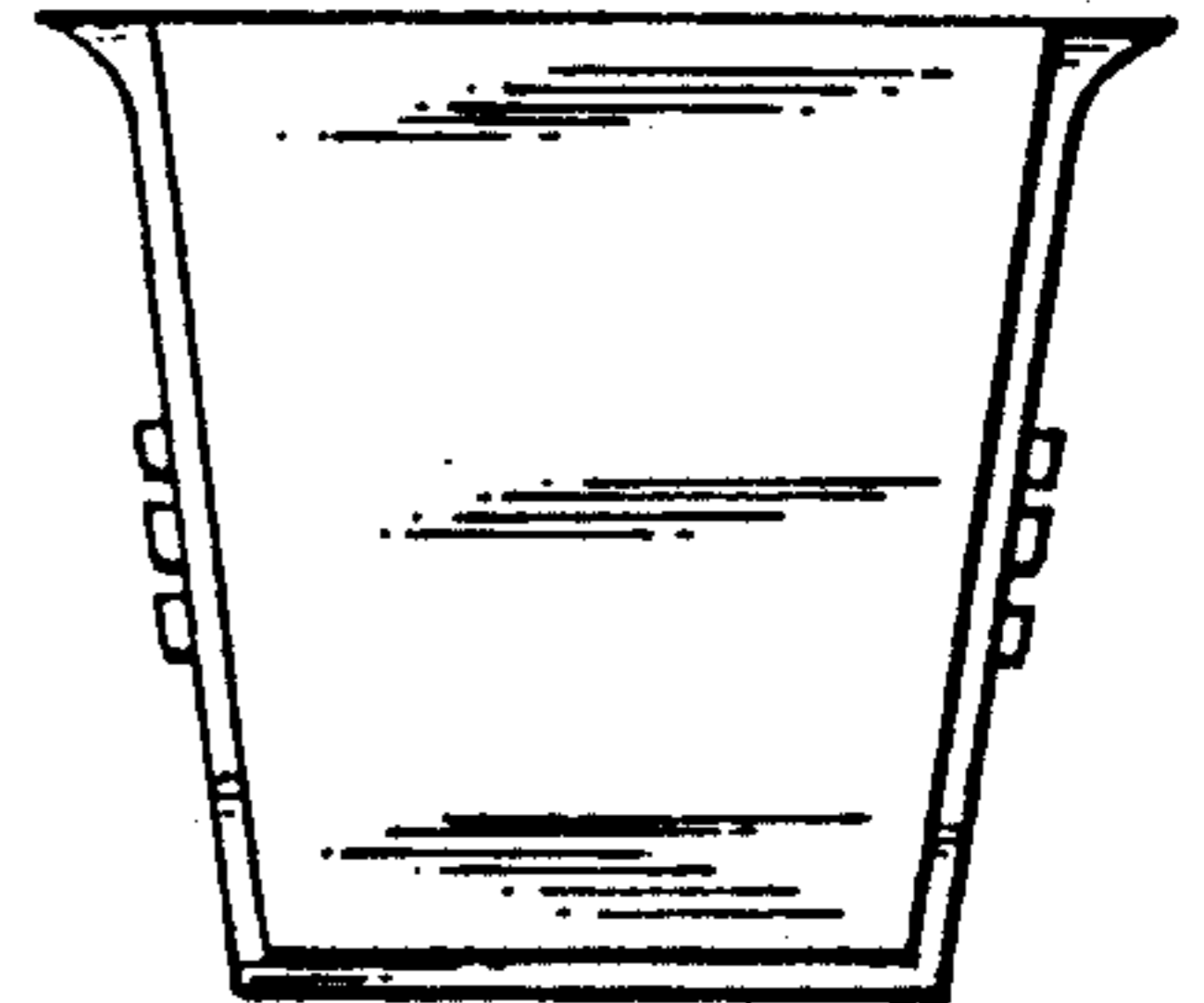

FIG. 4

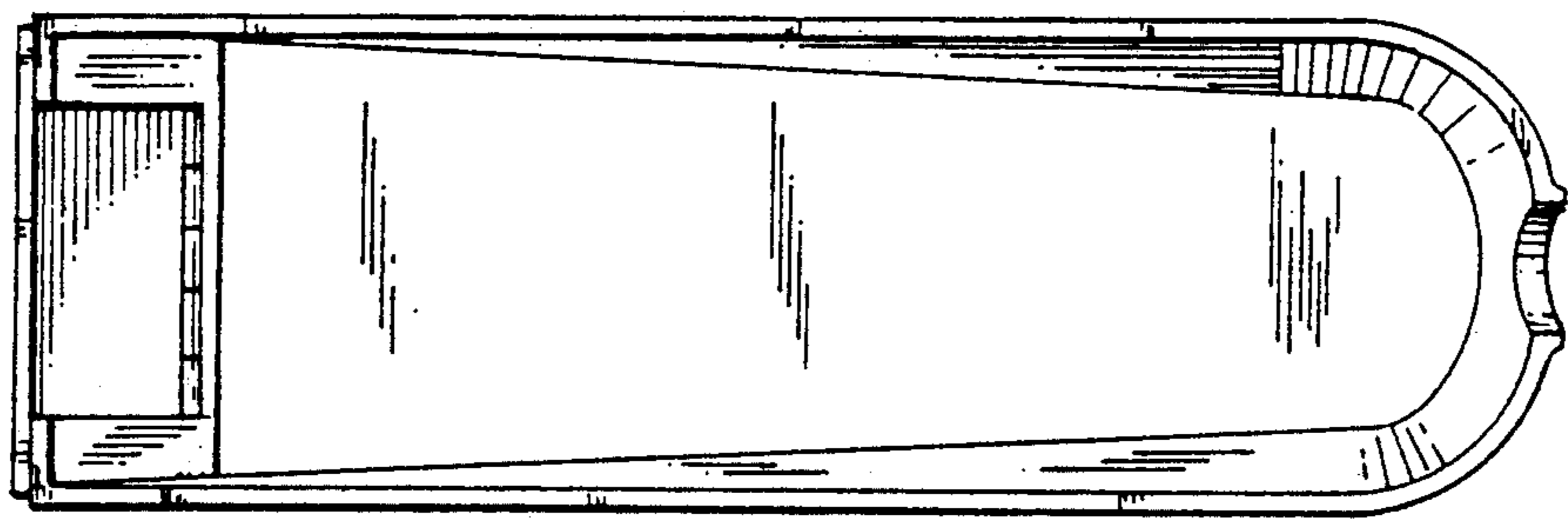

FIG. 5

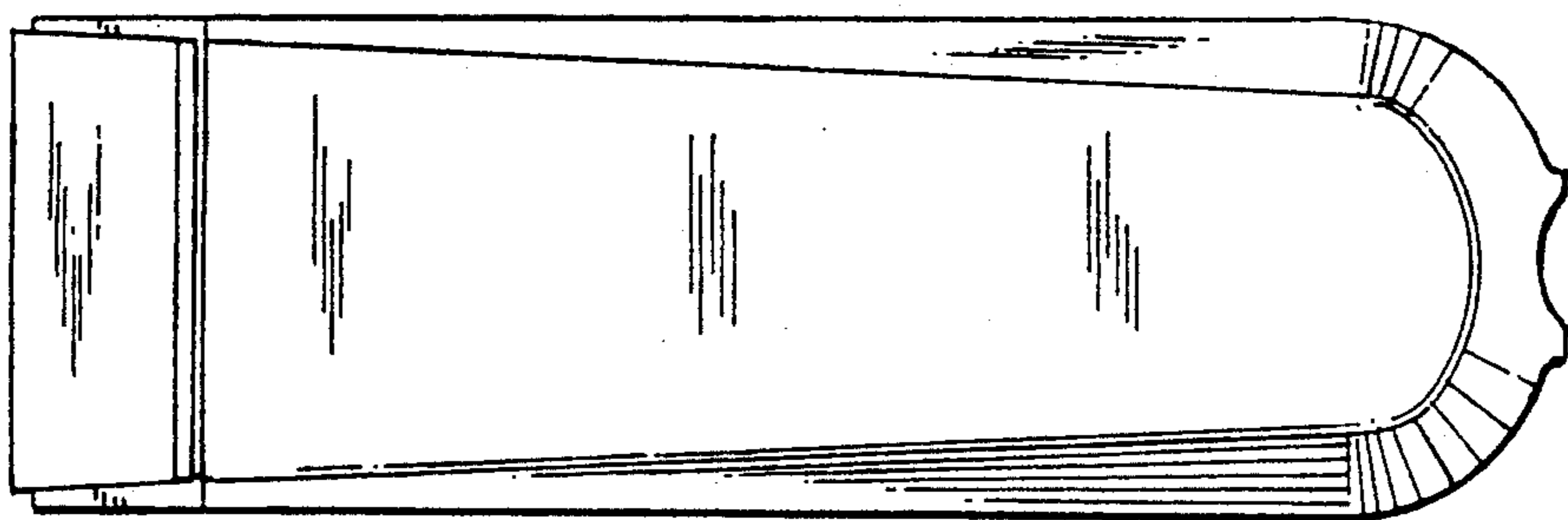

FIG. 6