

[54] **SUNGLASSES**

[76] **Inventor: Philip Downey, 3409 E. Cortez St.,
West Covina, Calif. 91791**

[**] **Term: 14 Years**

[21] **Appl. No.: 184,591**

[22] **Filed: Apr. 21, 1988**

[52] **U.S. Cl. D16/102**

[58] **Field of Search D16/101-123,
D16/125-128; D29/17; 351/41, 44-47, 50-52,
57, 58, 65, 68, 83, 85, 87, 88, 90, 102, 103,
106-109, 111, 114, 119, 123, 124; 2/9, 13, 15,
426, 431, 433, 435, 440, 448-451**

[56] **References Cited**

U.S. PATENT DOCUMENTS

D. 115,760 7/1939 English D16/112
D. 170,033 7/1953 Spencer D16/111
D. 289,301 4/1987 Jannard D16/116

FOREIGN PATENT DOCUMENTS

8101512 6/1981 European Pat. Off. 2/426
673815 1/1930 France .
790755 11/1935 France .
2472764 7/1981 France .

OTHER PUBLICATIONS

American Bicyclist, Mar. 1988, p. 3, A'ME's Sport Shades.

Primary Examiner—Carmen H. Vales-Lado
Attorney, Agent, or Firm—Charles H. Thomas

[57] **CLAIM**

The ornamental design for sunglasses, as shown and described.

DESCRIPTION

FIG. 1 is a perspective view of sunglasses illustrating my new design;
FIG. 2 is a front elevational view thereof;
FIG. 3 is a rear elevational view thereof;
FIG. 4 is a right side elevational view thereof;
FIG. 5 is a left side elevational view thereof;
FIG. 6 is a top plan view thereof;
FIG. 7 is a bottom plan view thereof.

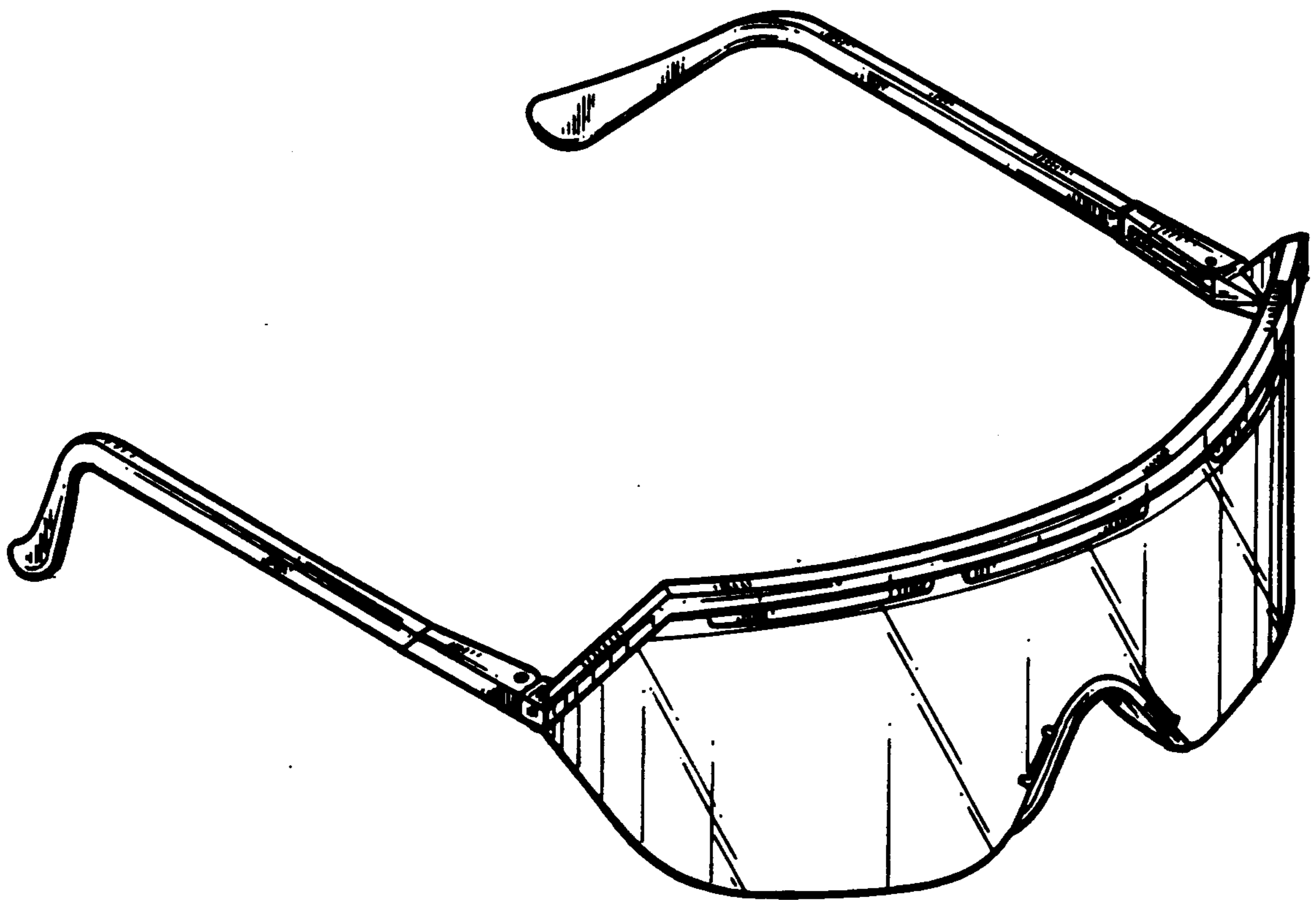

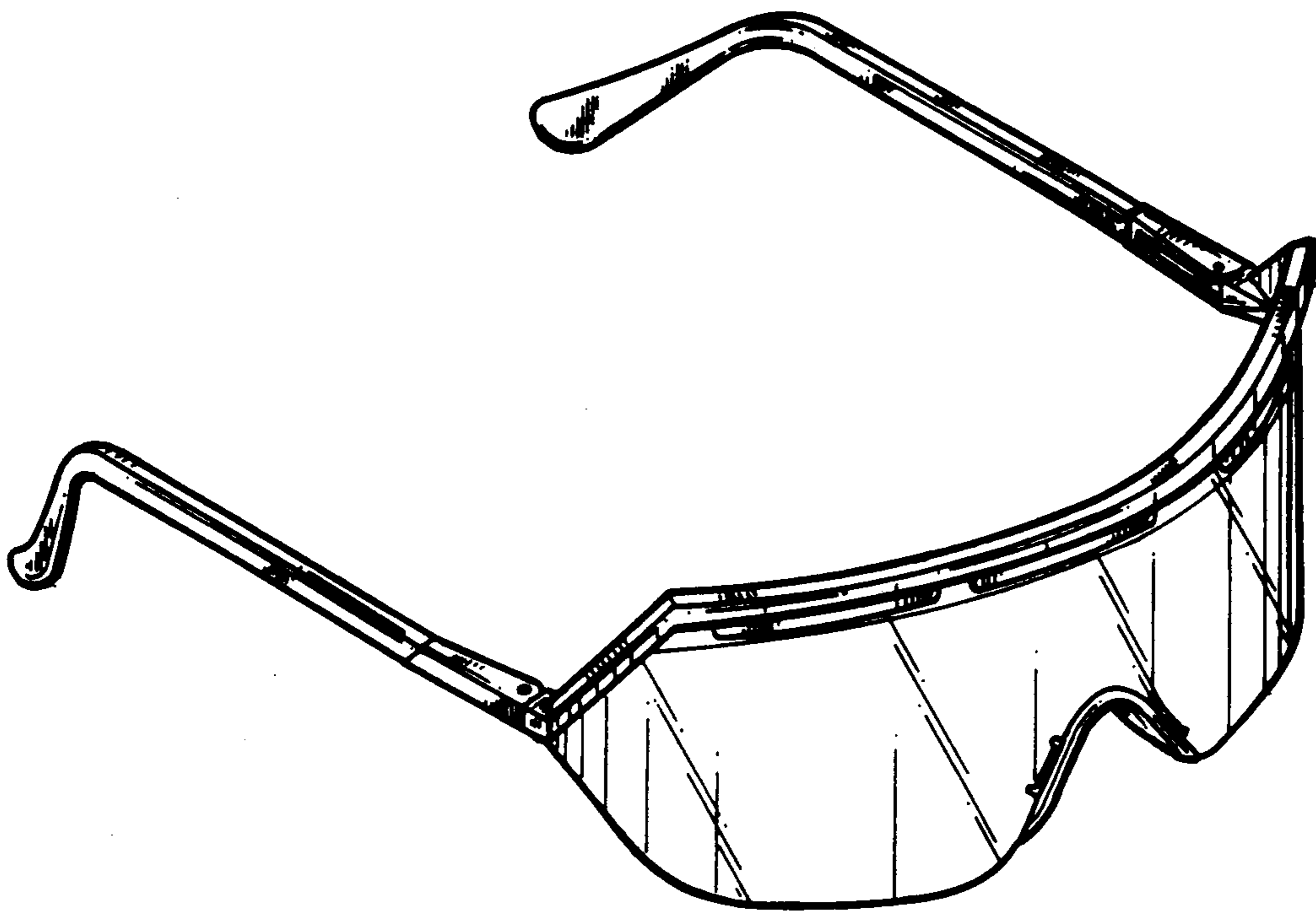

FIG. 1

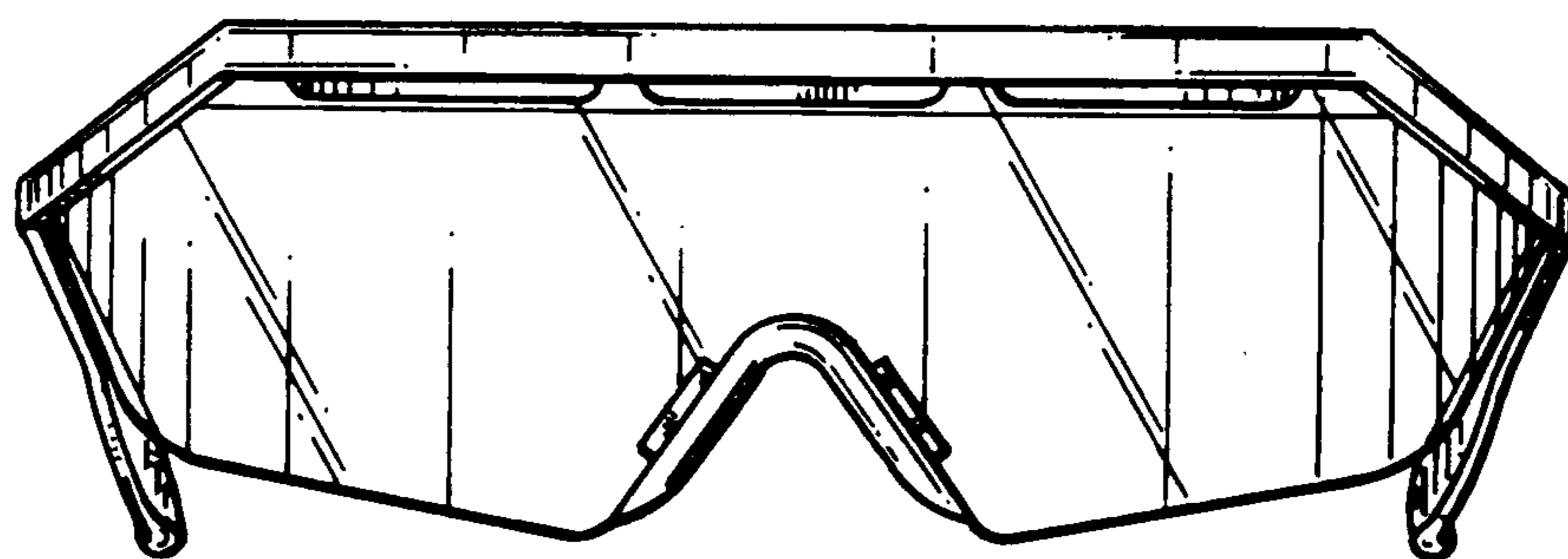

FIG. 2

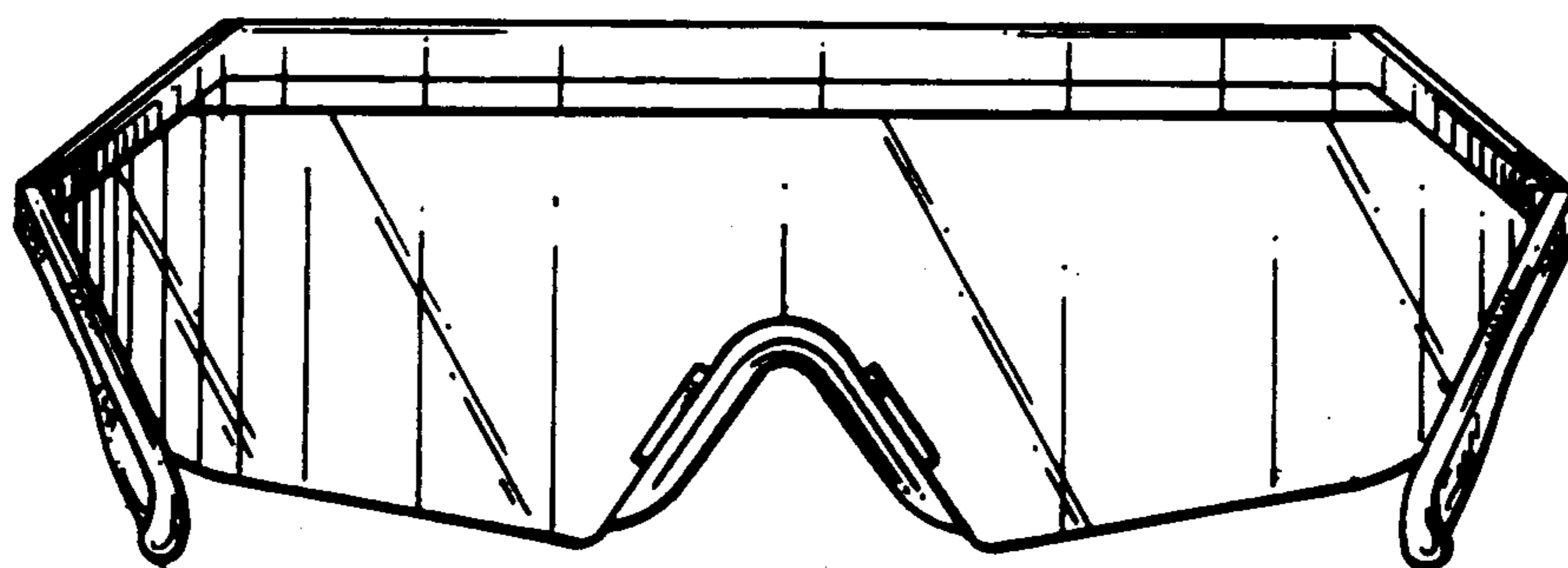

FIG. 3

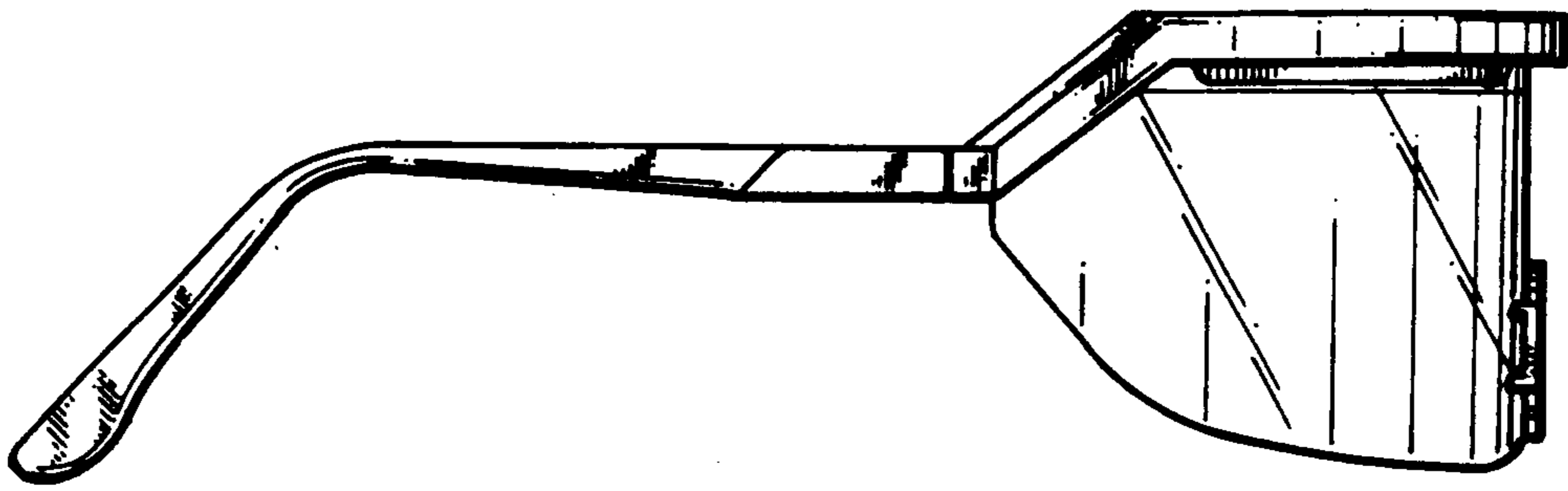

FIG. 4

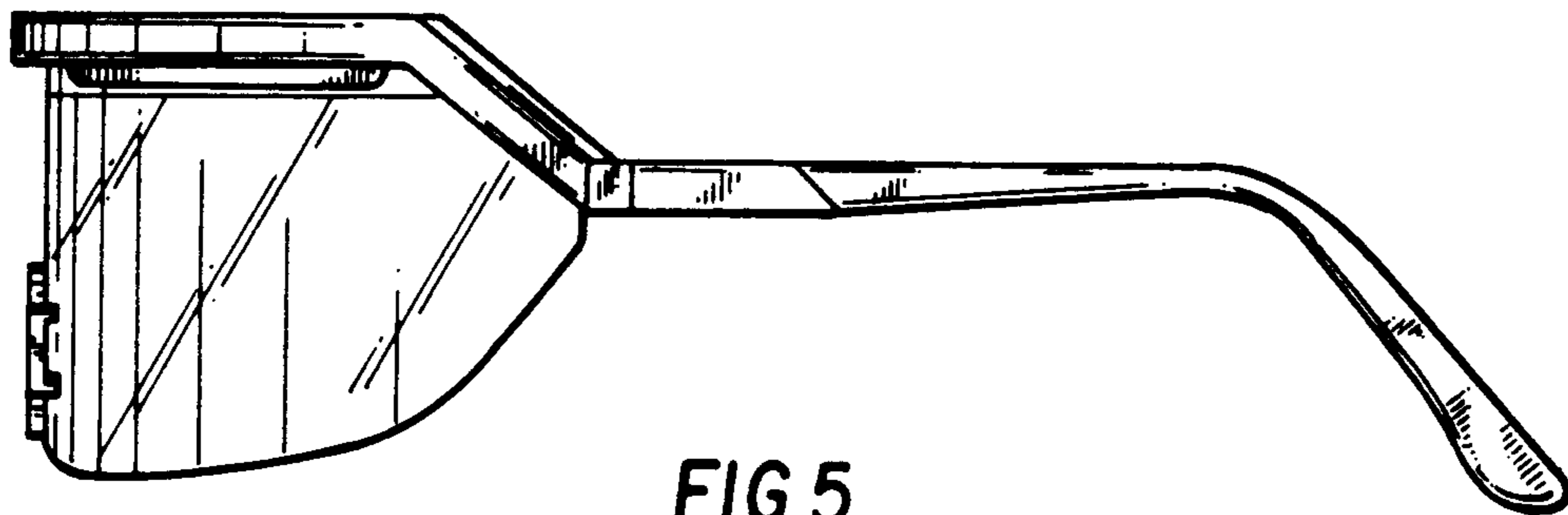

FIG. 5

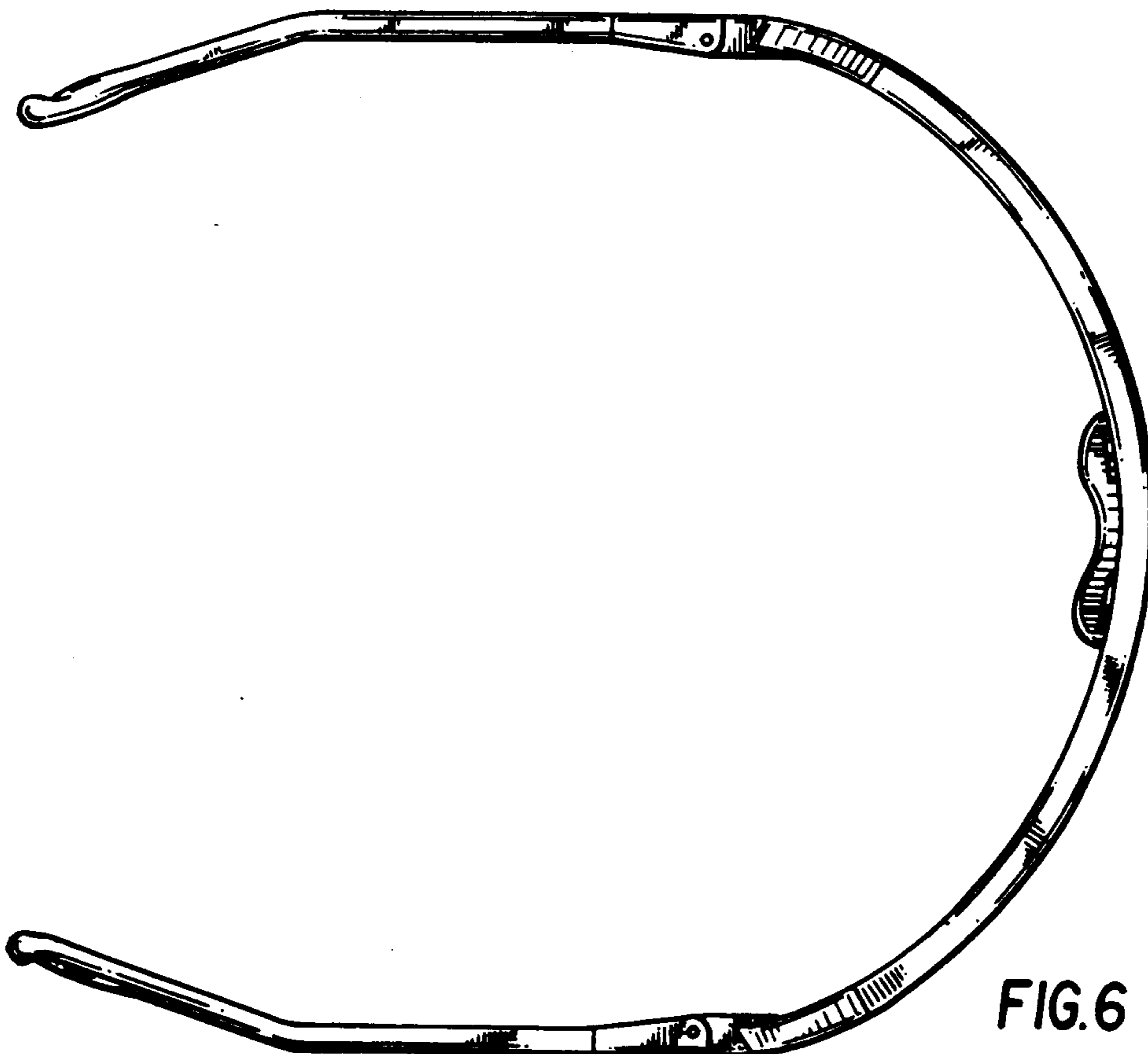

FIG. 6

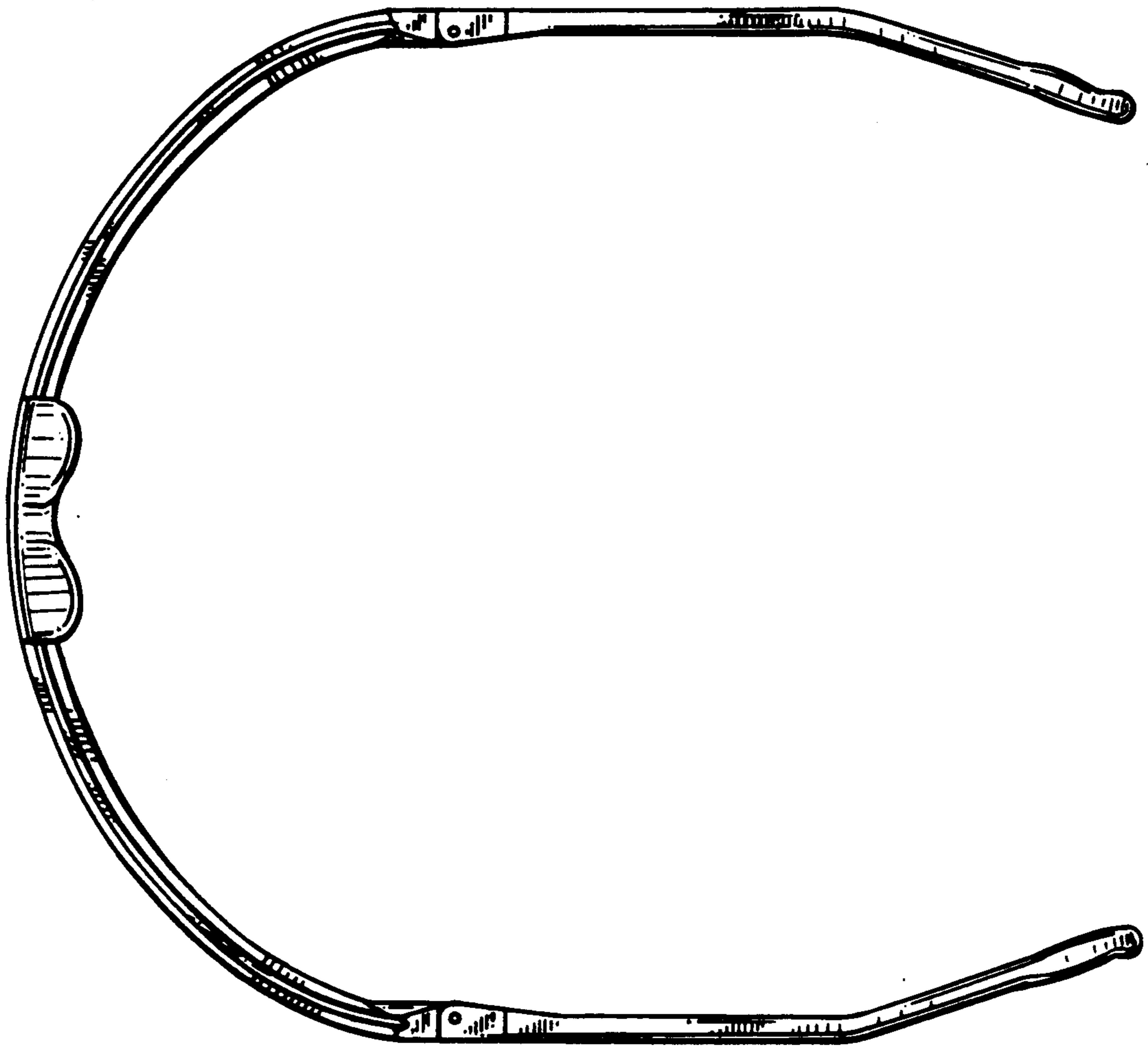

FIG. 7