

[54] **WATERBED**

[76] **Inventor: William E. Chambers, Jr., Rte. 3, Box 314B, Leland, N.C. 28451**

[**] **Term: 14 Years**

[21] **Appl. No.: 160,109**

[22] **Filed: Feb. 25, 1988**

[52] **U.S. Cl. D6/382**

[58] **Field of Search D6/382-384, D6/390-395, 503-508, 596, 601, 604, 605**

[56] **References Cited**

U.S. PATENT DOCUMENTS

D. 47,535	7/1915	Huntoon	D6/384
D. 262,332	12/1981	Keller	D6/505
D. 264,889	6/1982	Thomas, II	D6/384
D. 280,475	9/1985	Testa	D6/384
D. 296,502	7/1988	Keller	D6/384

OTHER PUBLICATIONS

Furniture Retailer, 1955, p. 29, Captain's Bunk in lower left panel.

United Bedrooms, p. 4, Waterbed, bottom panel.

Primary Examiner—Bruce W. Dunkins

Assistant Examiner—Janice E. Seeger

Attorney, Agent, or Firm—Jerry T. Kearns

[57] **CLAIM**

The ornamental design for a waterbed, as shown and described.

DESCRIPTION

FIG. 1 is a front elevational view of a water bed showing my new design;

FIG. 2 is a rear elevational view thereof;

FIG. 3 is a left side elevational view thereof;

FIG. 4 is a right side elevational view thereof;

FIG. 5 is a top plan view thereof;

FIG. 6 is a bottom plan view thereof; and,

FIG. 7 is a perspective view thereof.

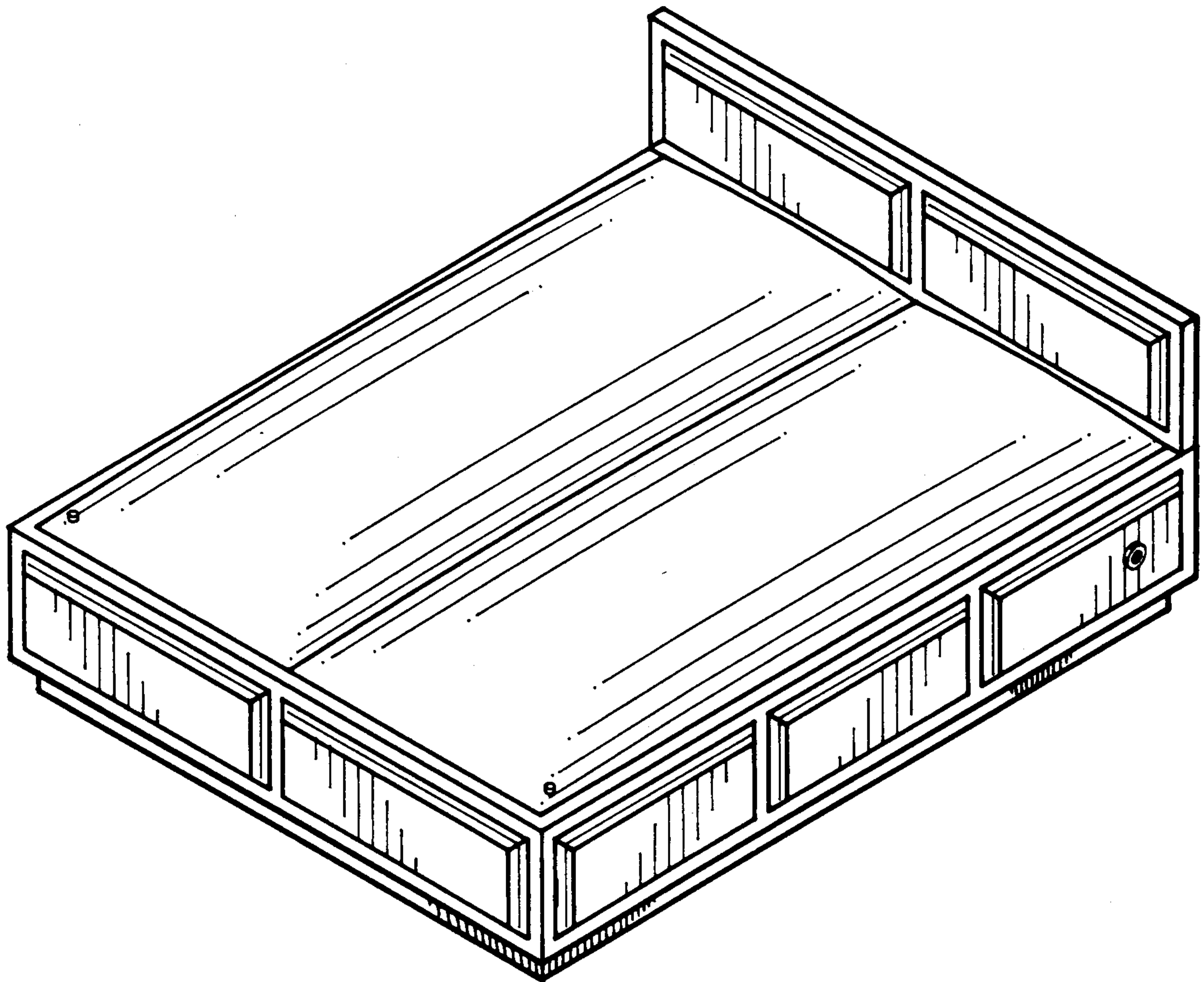

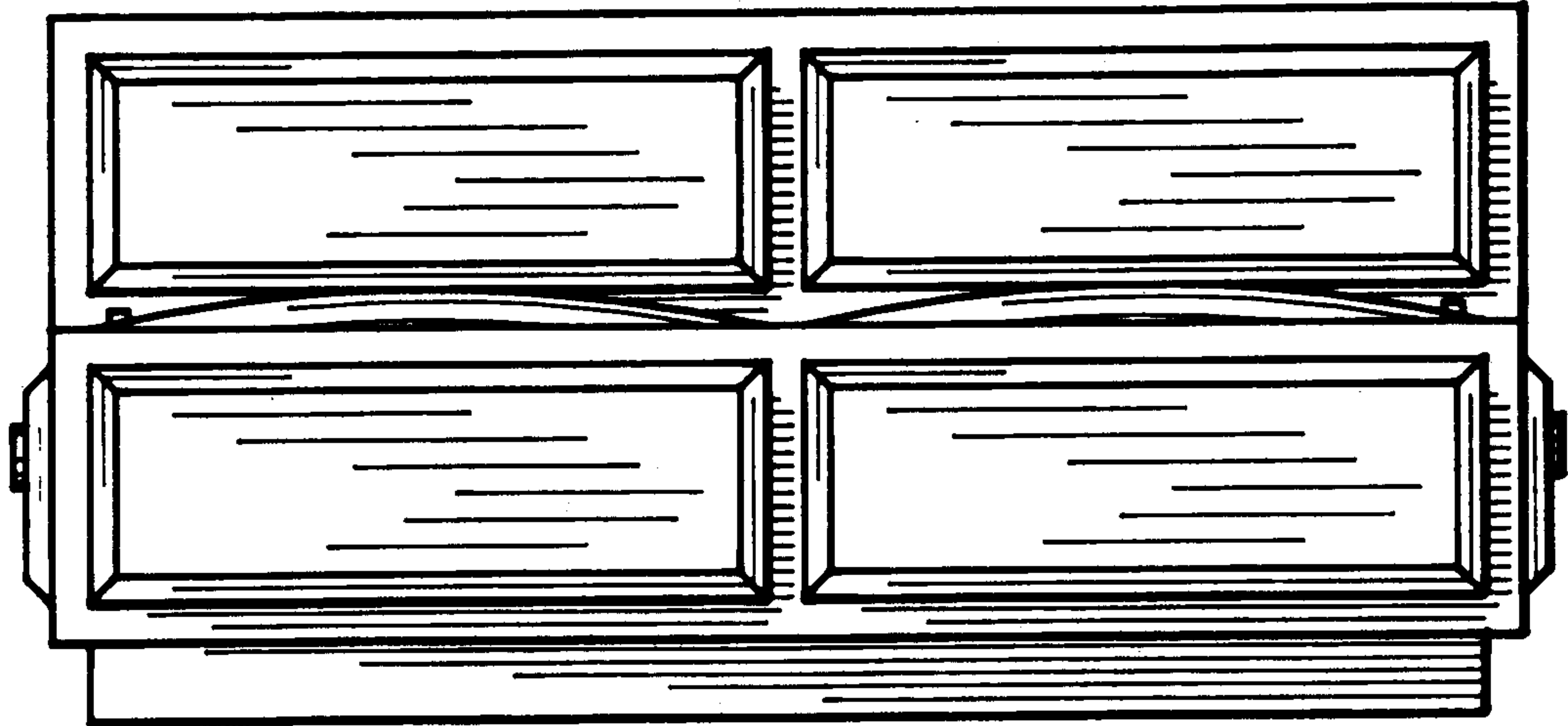

Fig. 1

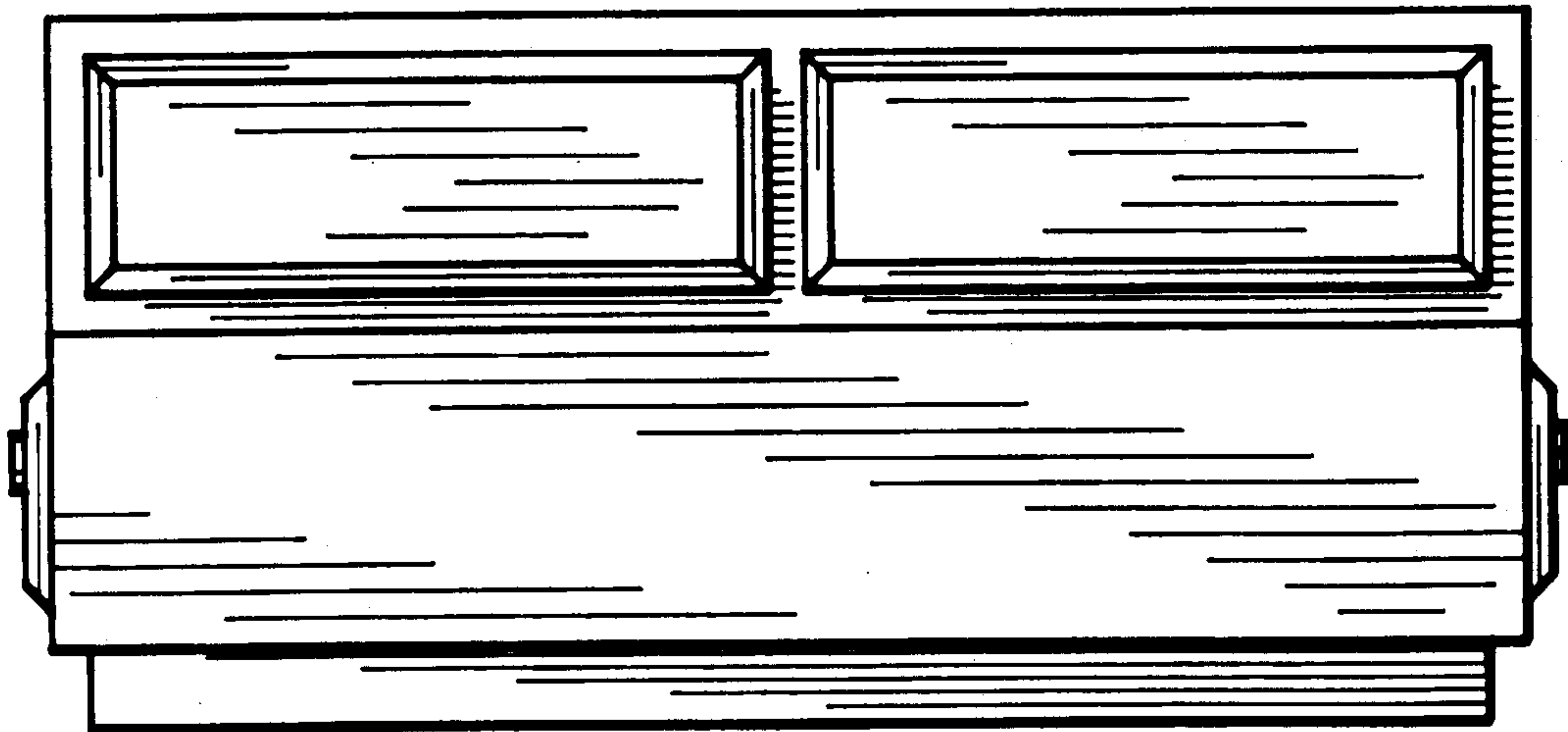

Fig. 2

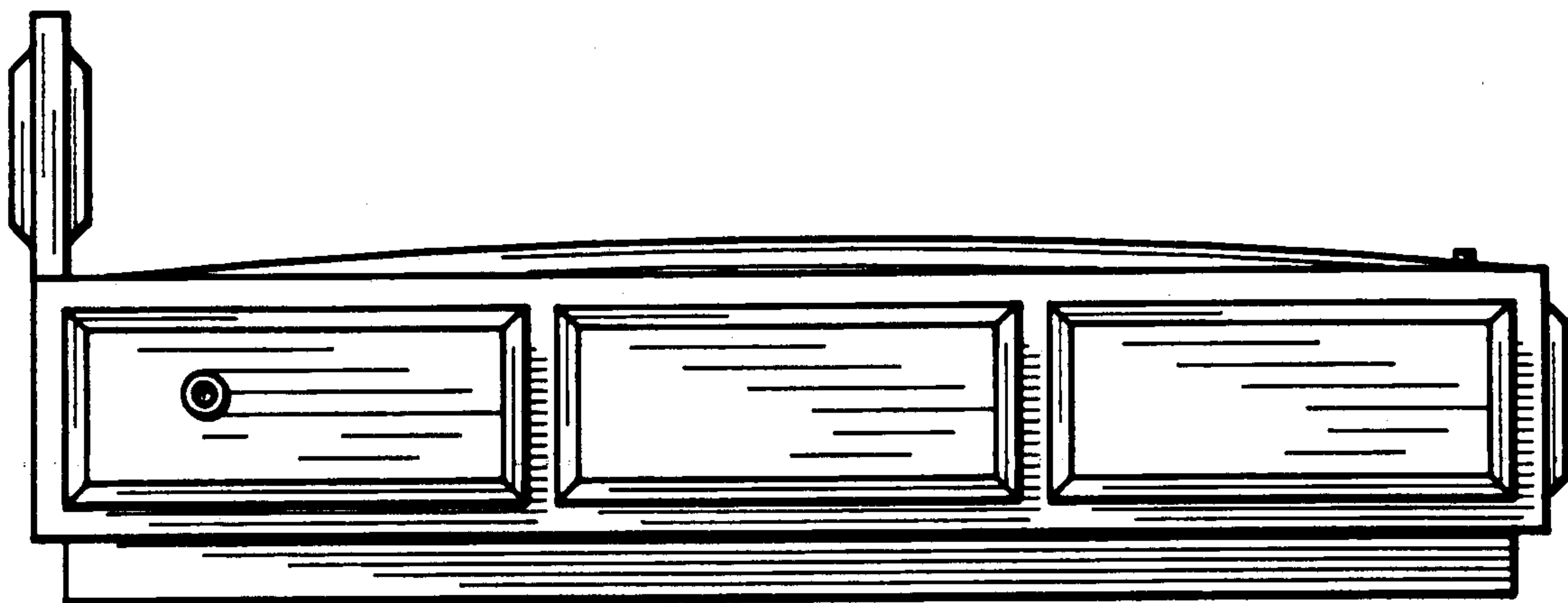

Fig. 3

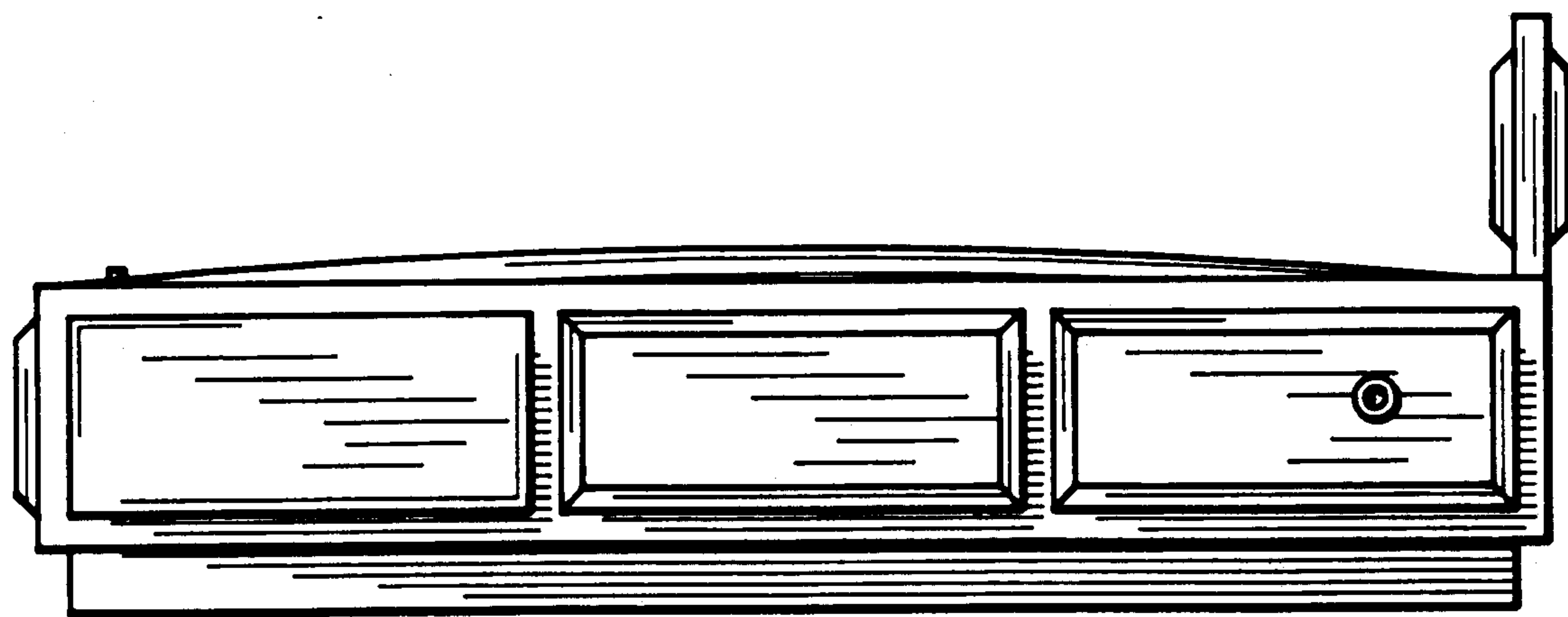

Fig. 4

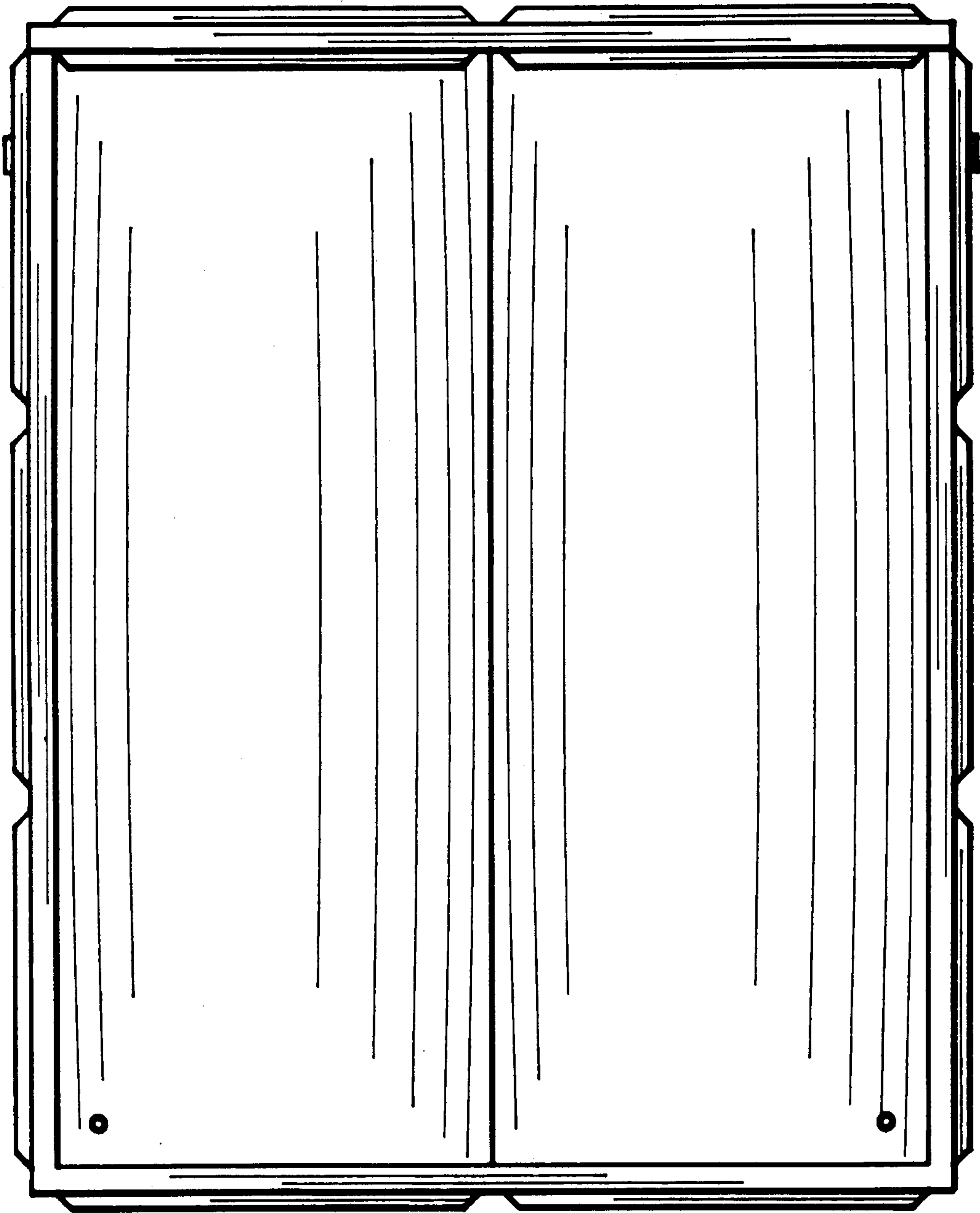

Fig. 5

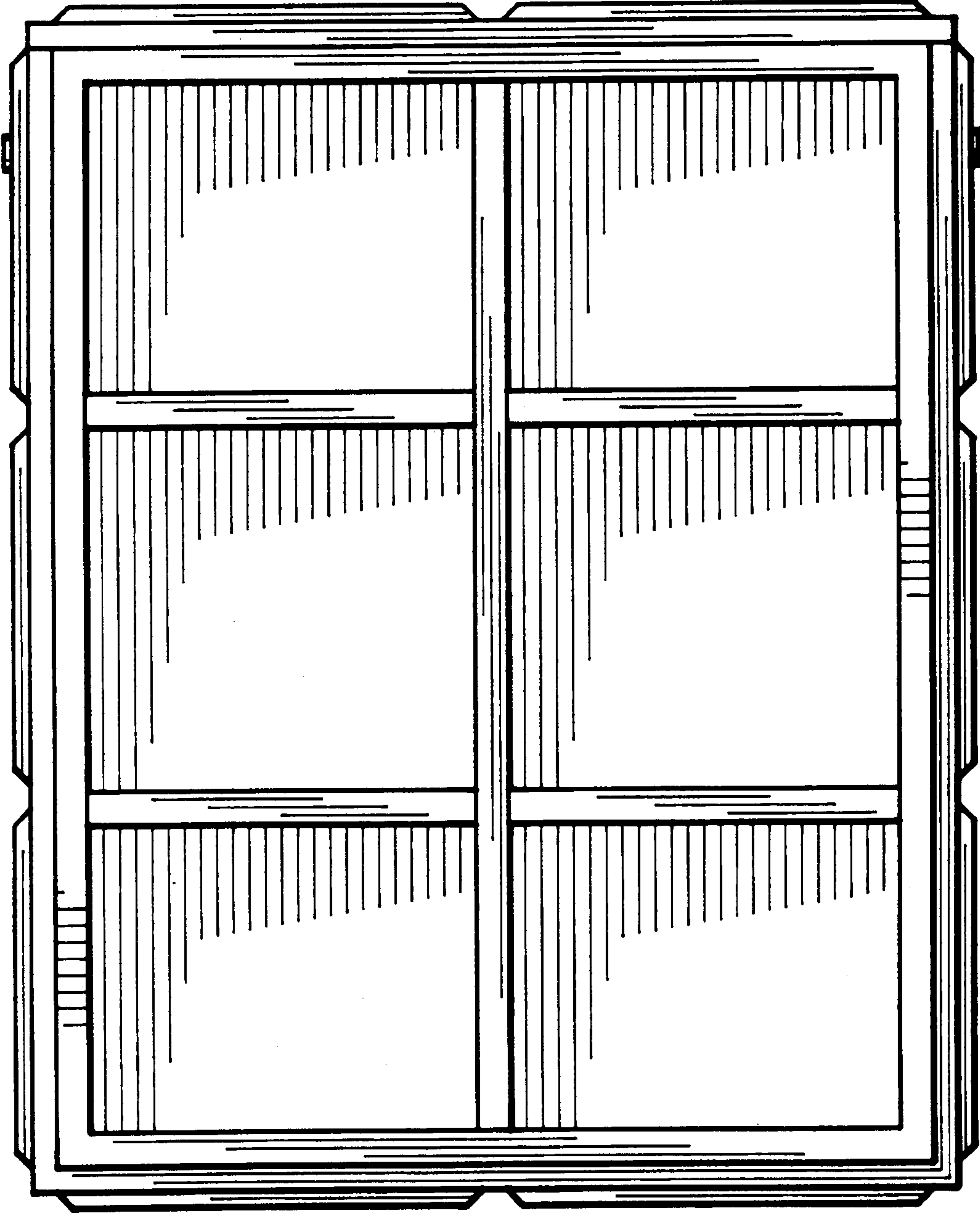

Fig. 6

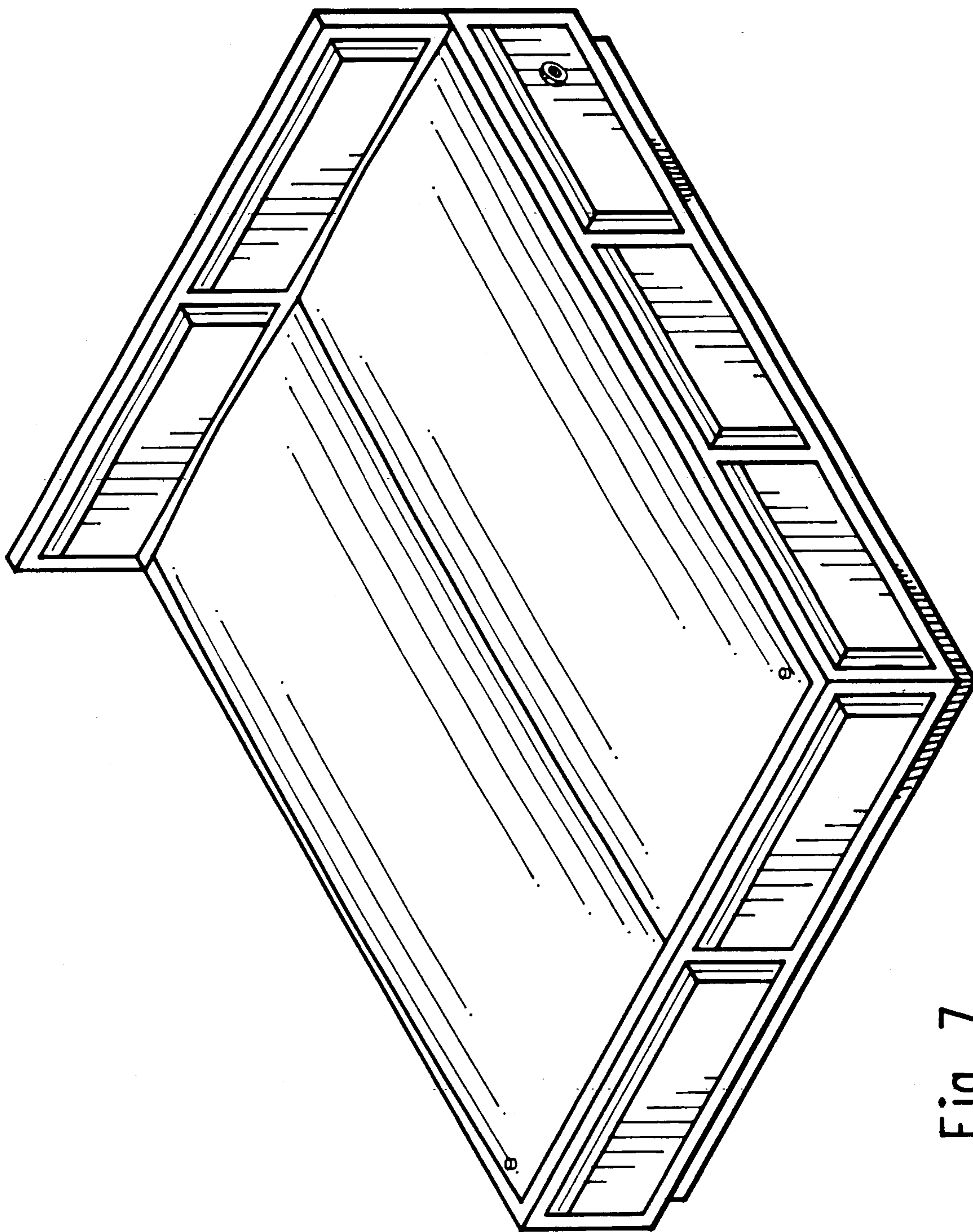

Fig. 7