

[54] STUFFED TOY HELICOPTER

[76] Inventor: Antoinette T. Doles, 8008 N. 38th Ave., Phoenix, Ariz. 85051

[**] Term: 14 Years

[21] Appl. No.: 190,521

[22] Filed: May 5, 1988

[52] U.S. Cl. D21/155; D21/90

[58] Field of Search D21/155, 90; 446/369

[56] References Cited

U.S. PATENT DOCUMENTS

- D. 294,721 3/1988 Cowling D21/155
- D. 295,766 5/1988 Hahn D21/90
- D. 304,054 10/1989 Van Meter D21/155

Primary Examiner—Melvin B. Feifer

Attorney, Agent, or Firm—H. Gordon Shields

[57] CLAIM

The ornamental design for stuffed toy helicopter, as shown and described.

DESCRIPTION

FIG. 1 is an upper right front view of a stuffed toy helicopter showing my design.

FIG. 2 is a rear view thereof.

FIG. 3 is a bottom view thereof.

FIG. 4 is a top view thereof.

FIG. 5 is a left side view thereof.

FIG. 6 is a front view thereof.

FIG. 7 is an upper right front perspective view of a modified form of my design for the stuffed toy helicopter.

FIG. 8 is a front view thereof.

FIG. 9 is a top view thereof.

FIG. 10 is a bottom view thereof.

FIG. 11 is a left side view thereof.

FIG. 12 is a rear view thereof.

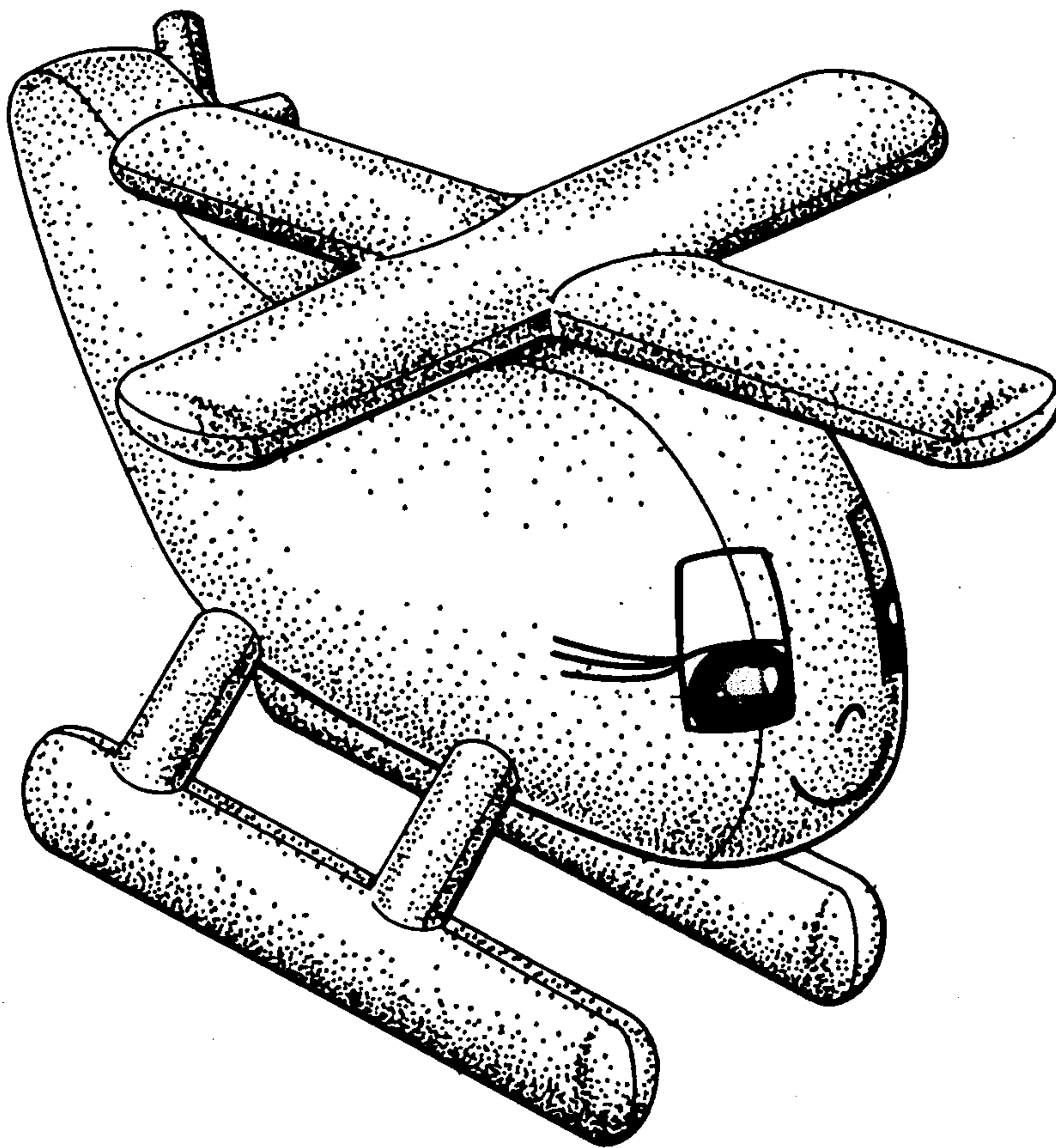

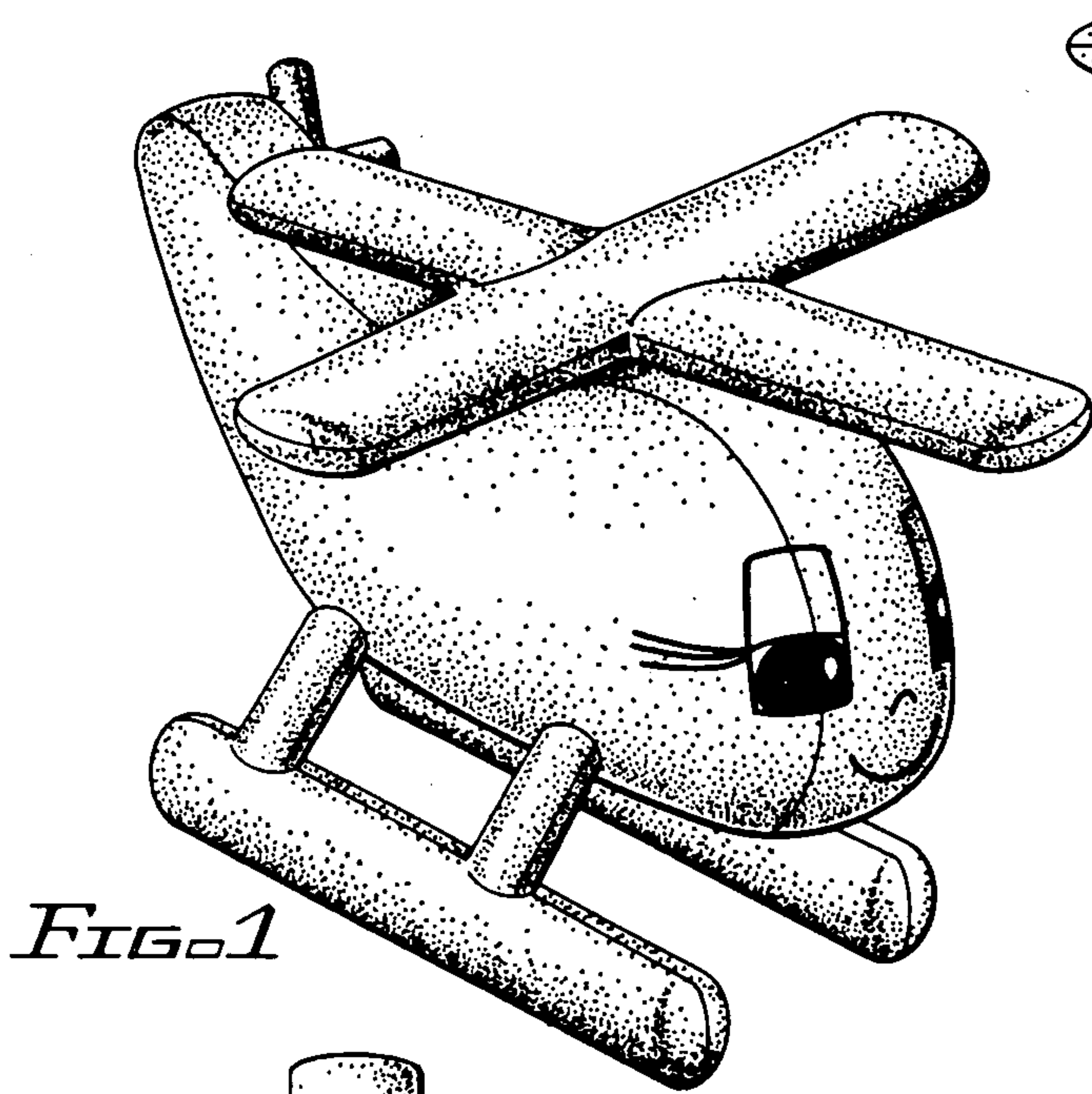

FIG. 1

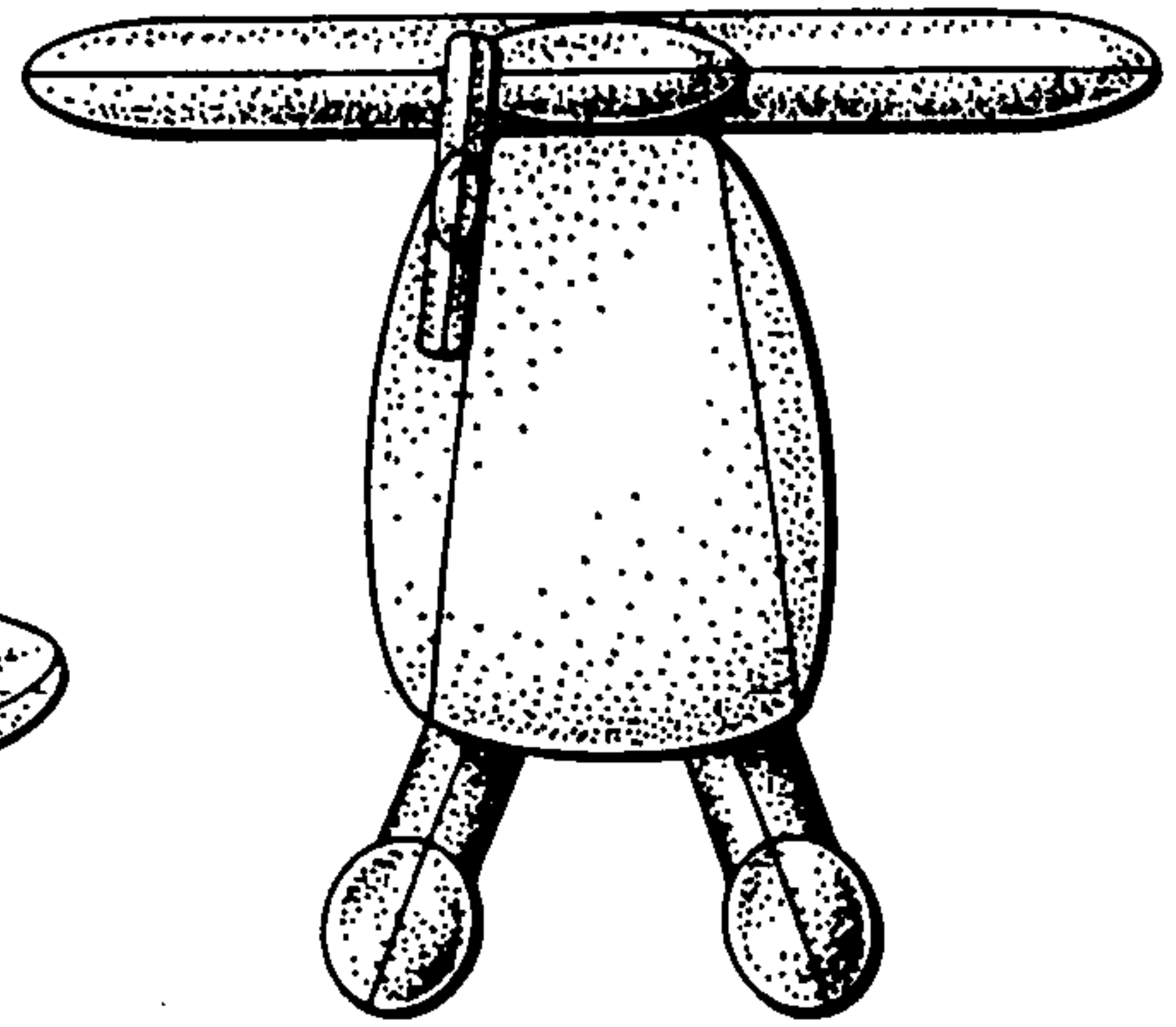

FIG. 2

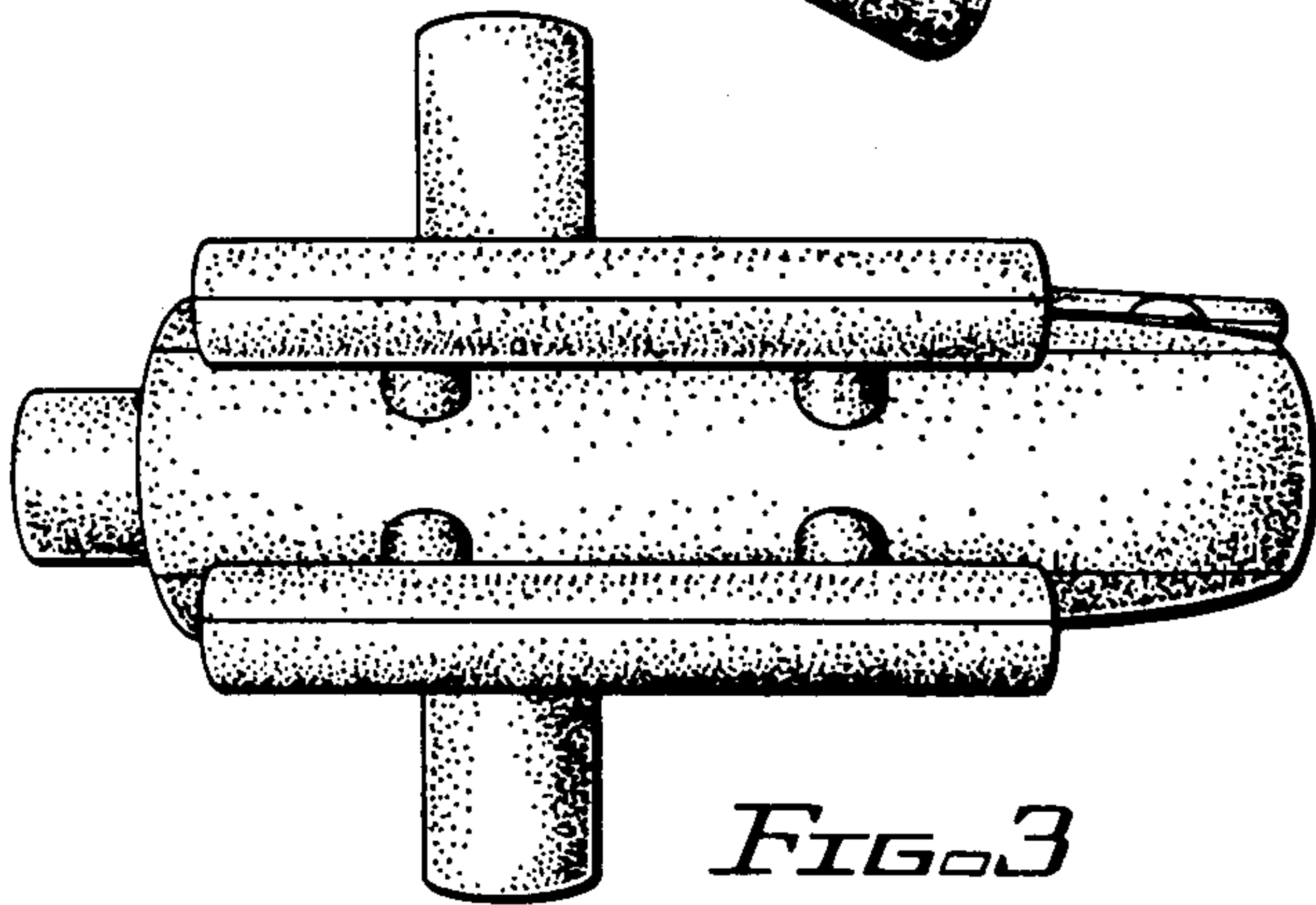

FIG. 3

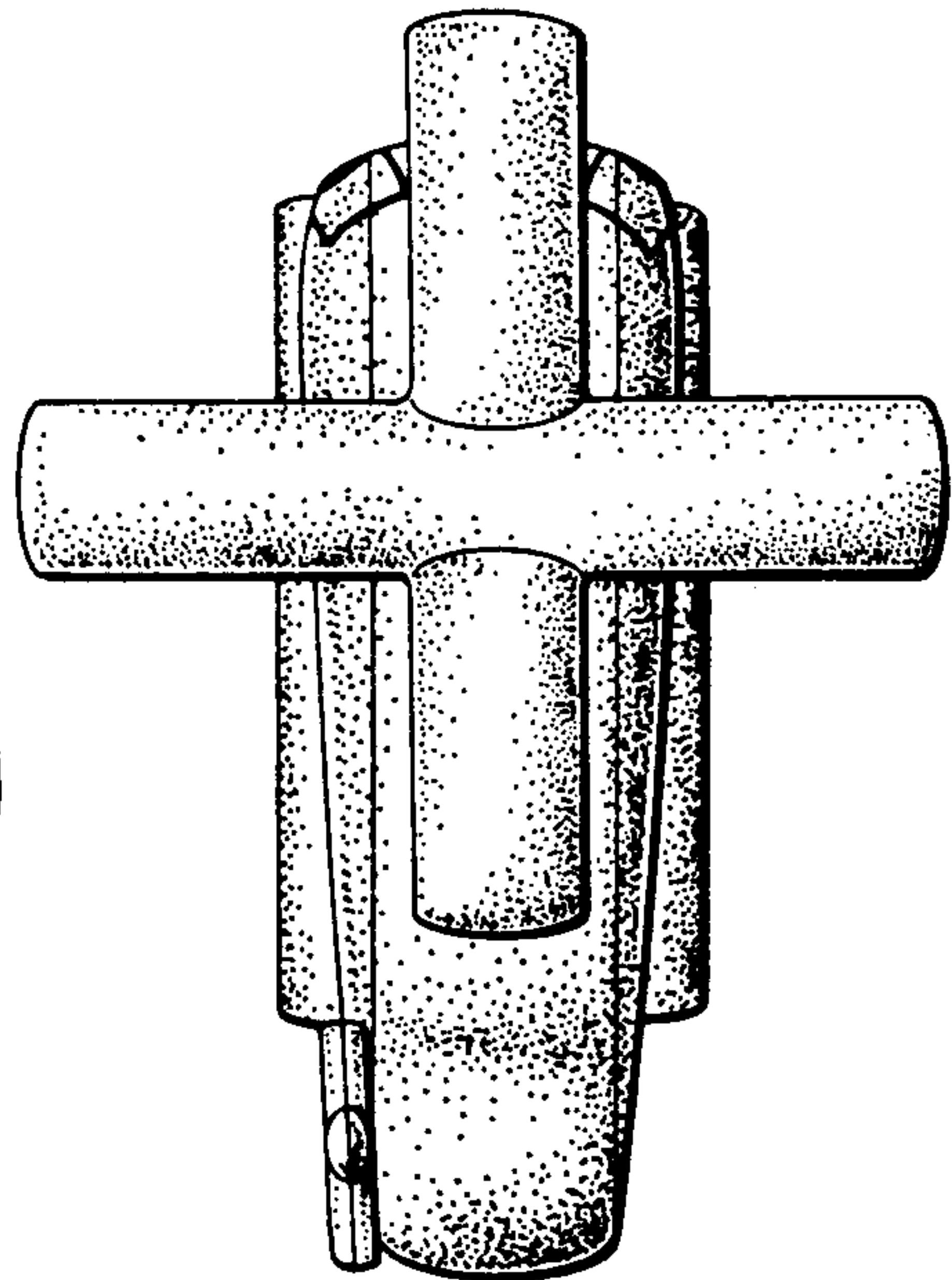

FIG. 4

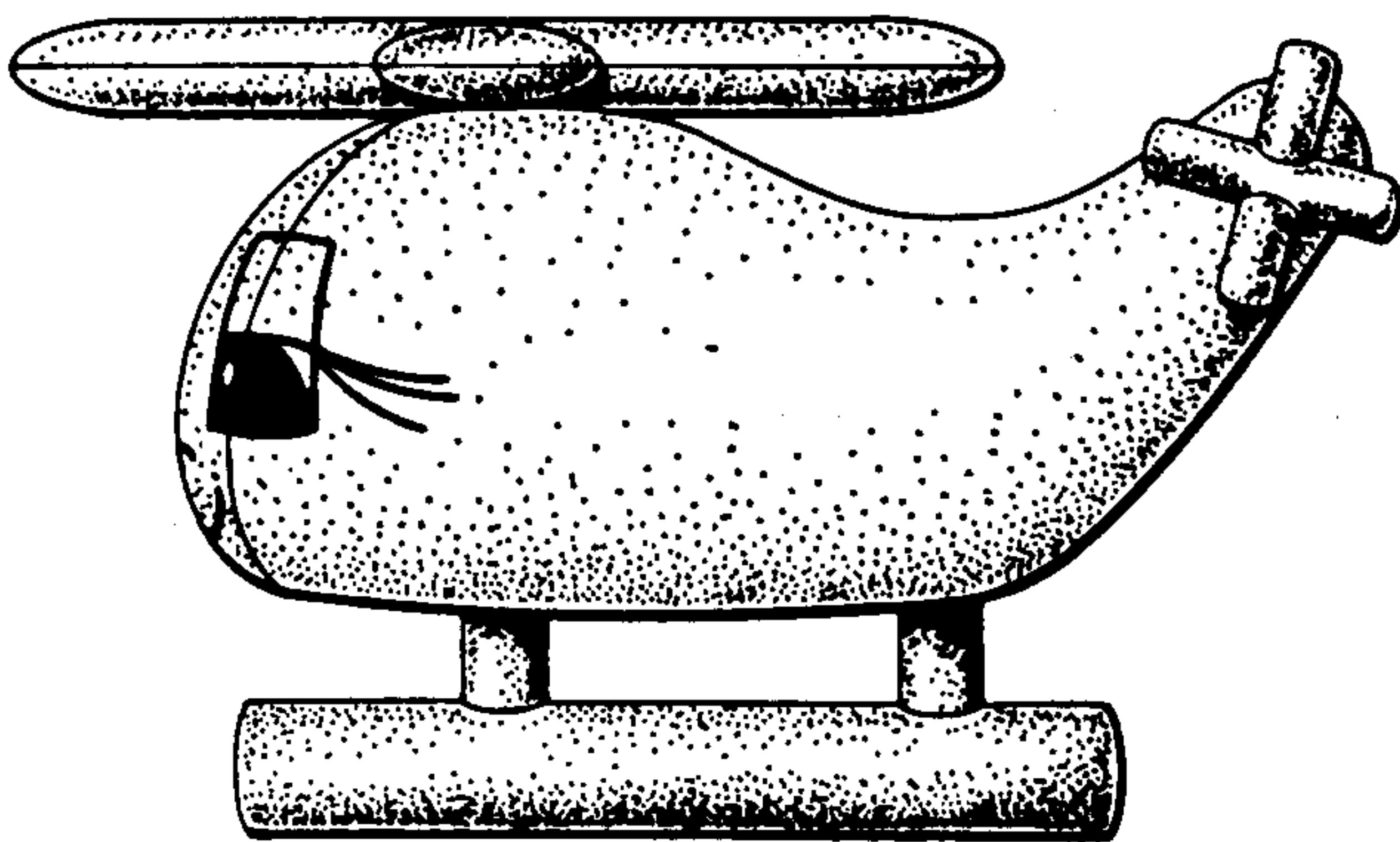

FIG. 5

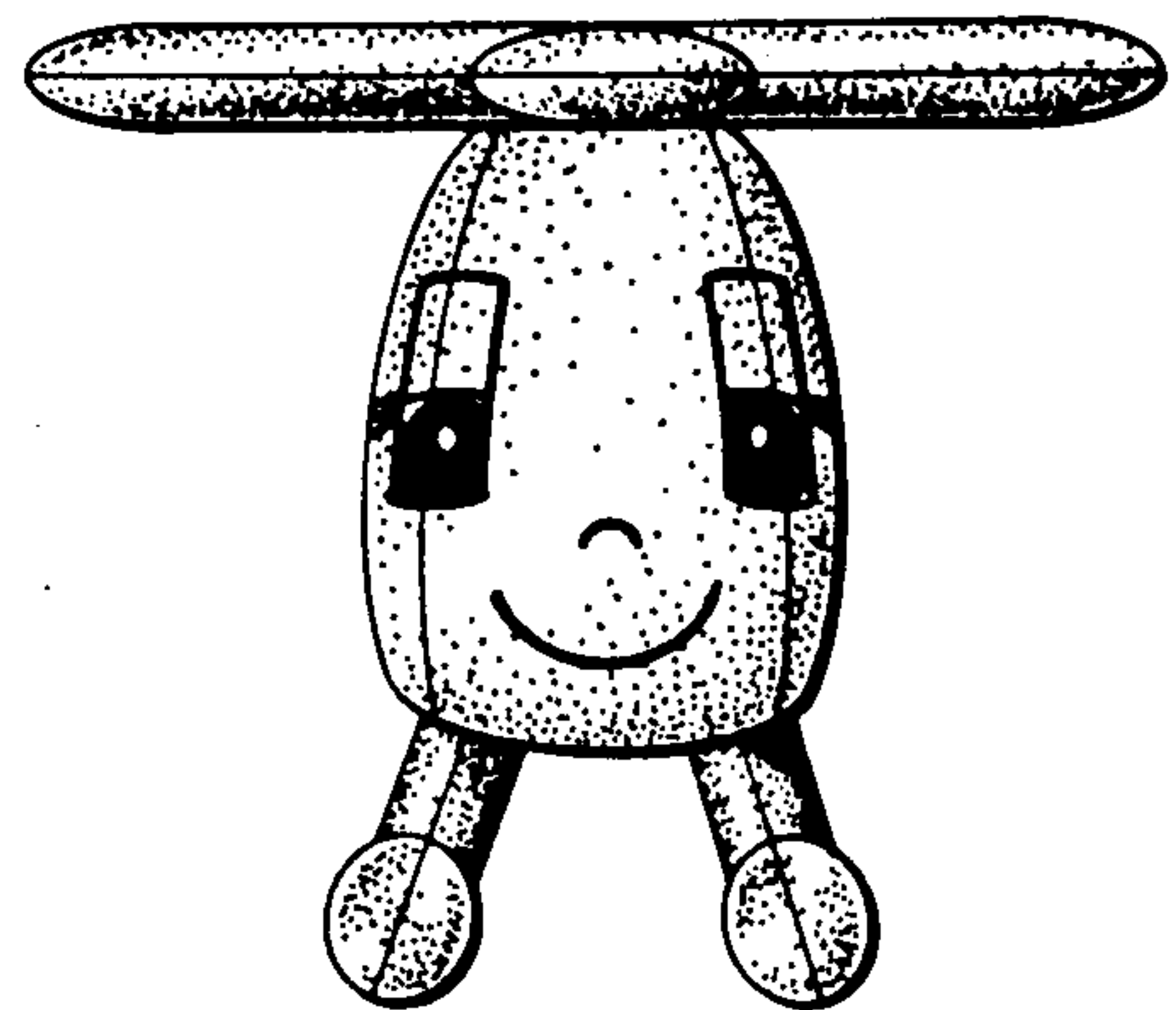

FIG. 6

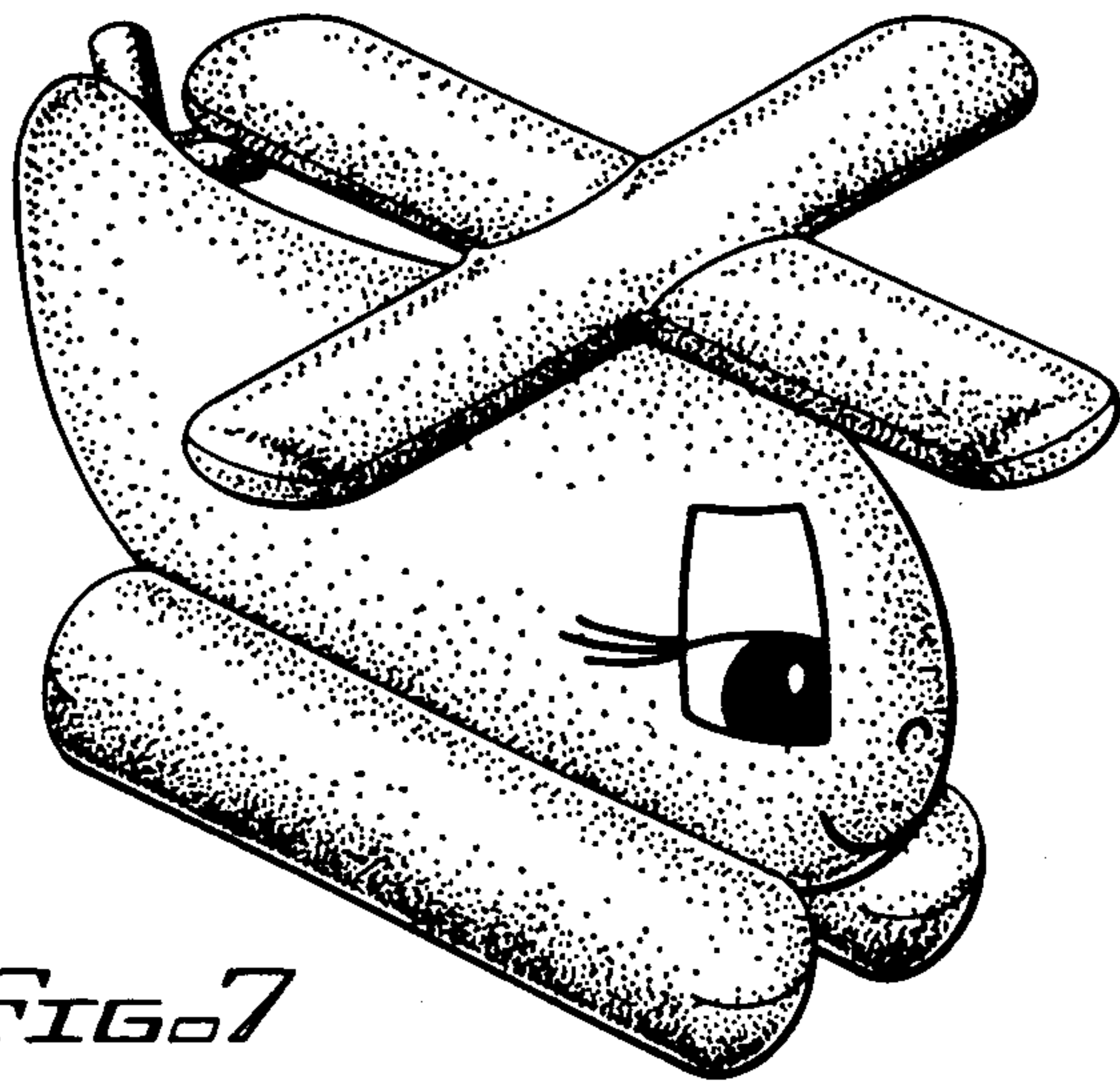

FIG. 7

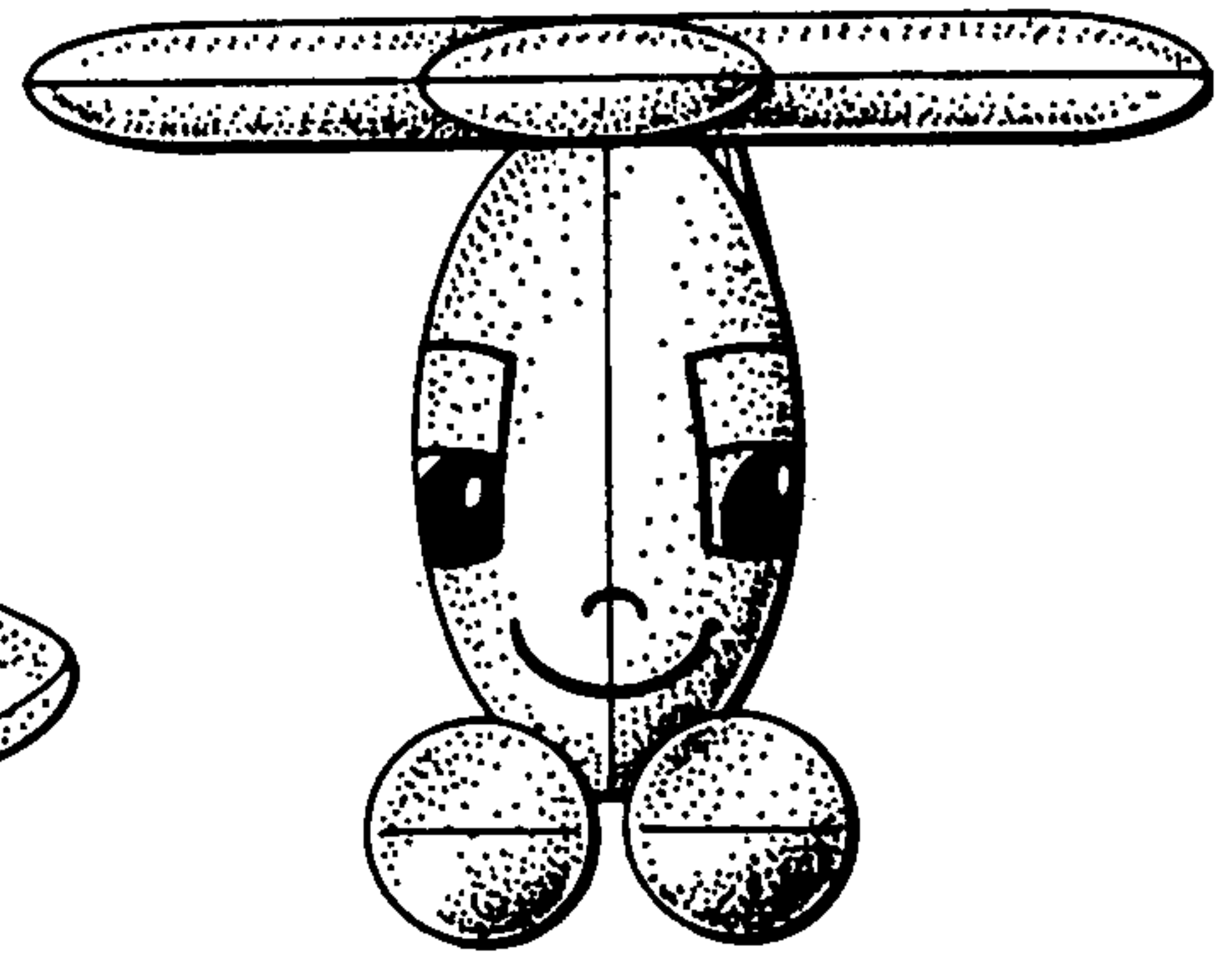

FIG. 8

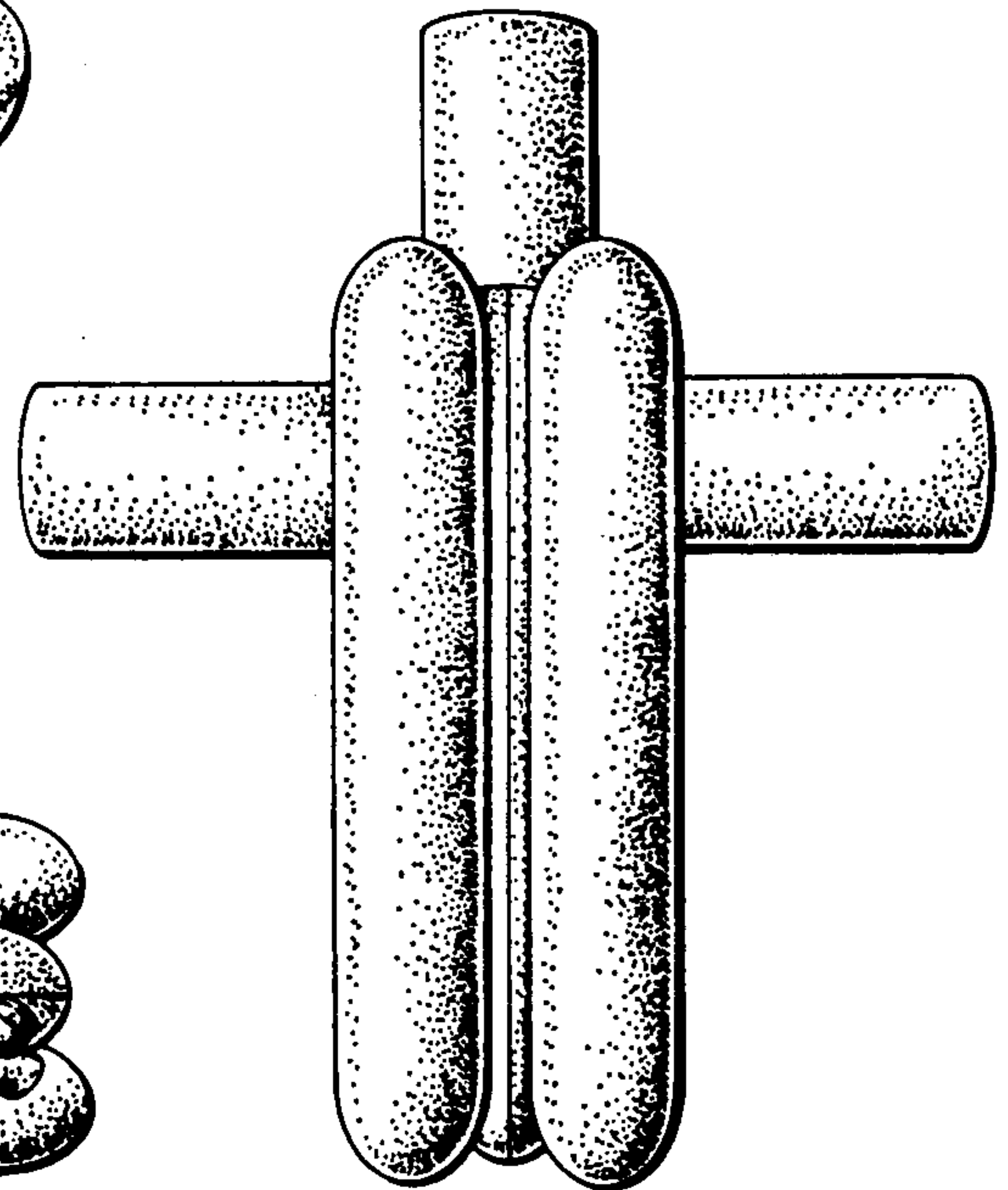

FIG. 10

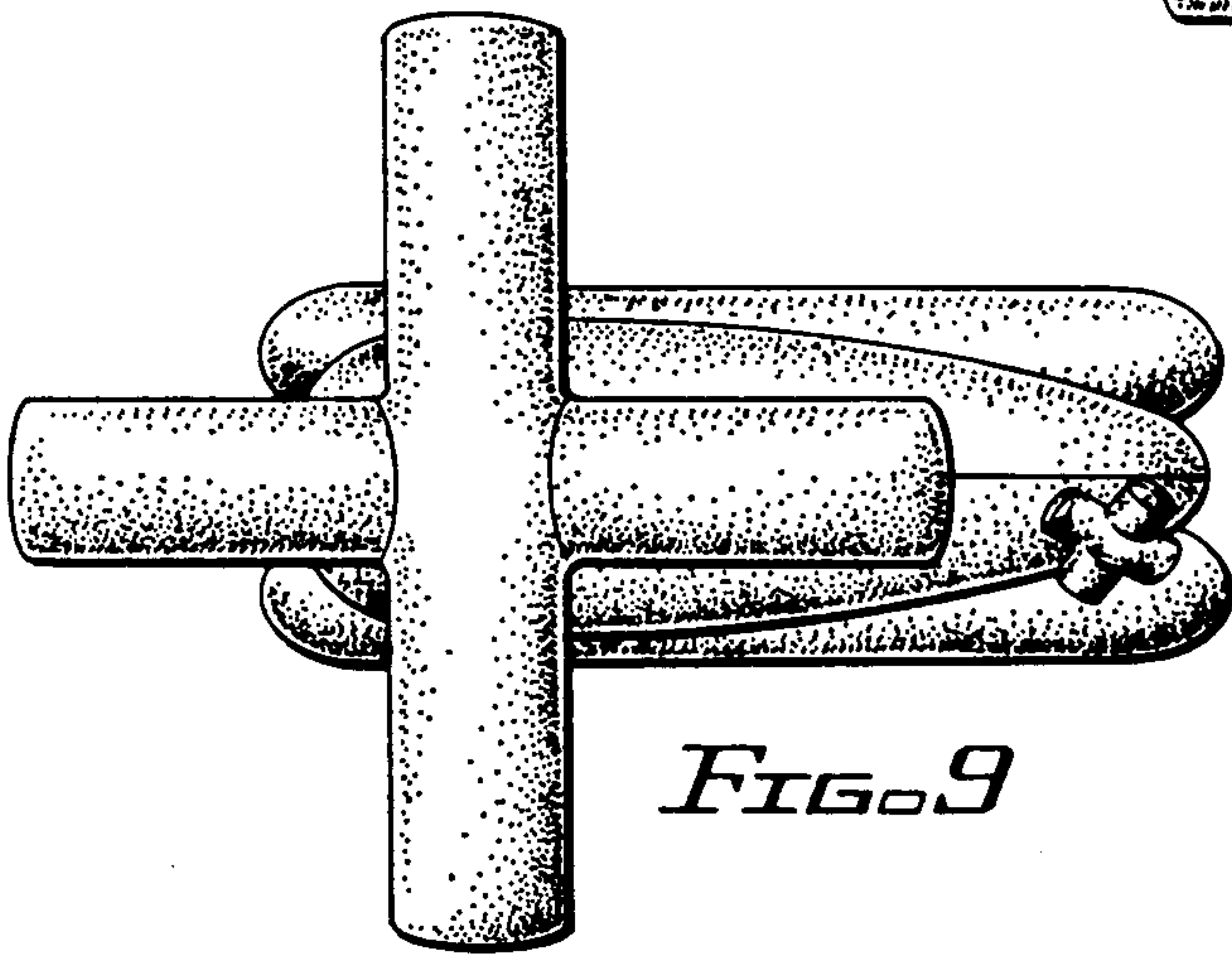

FIG. 9

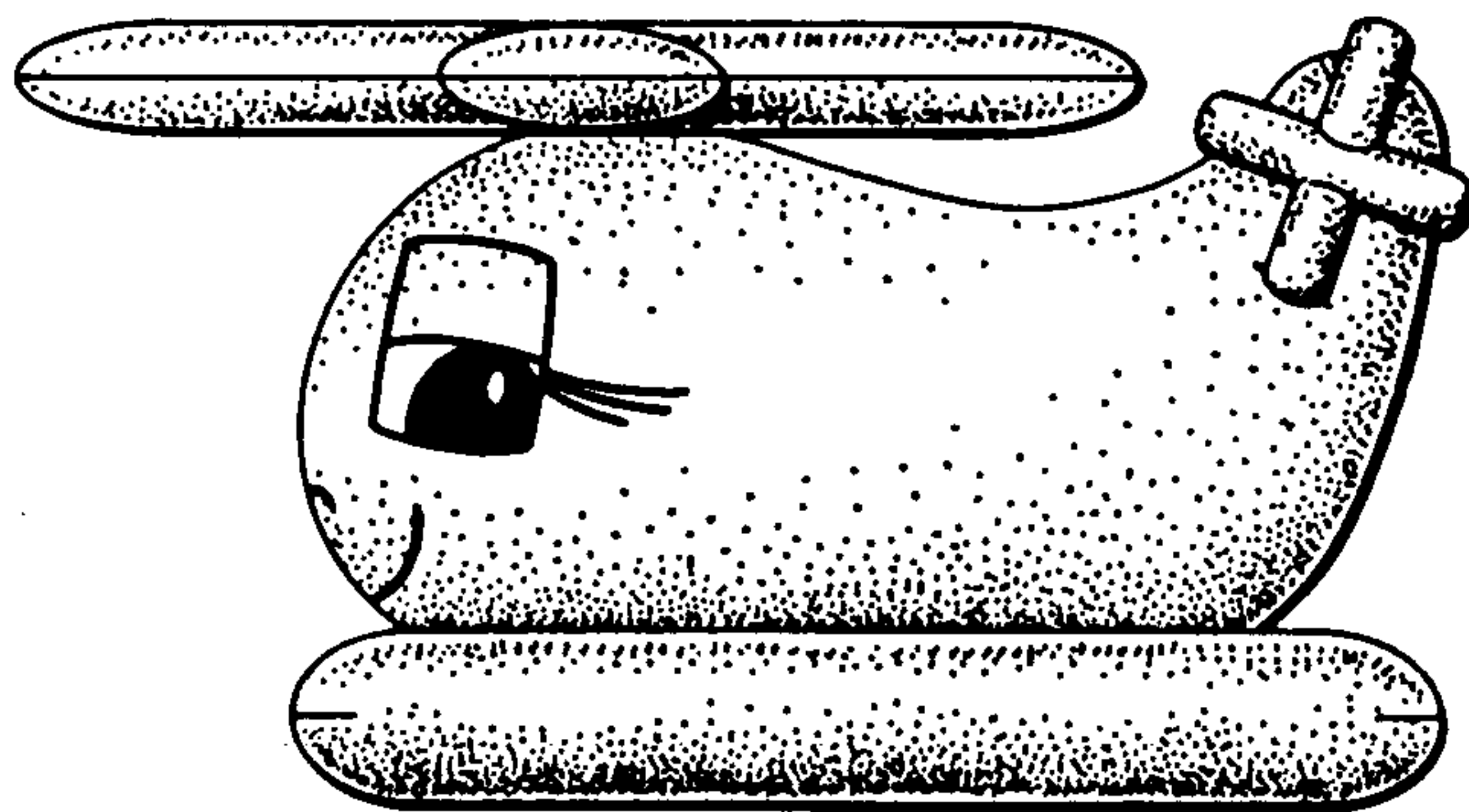

FIG. 11

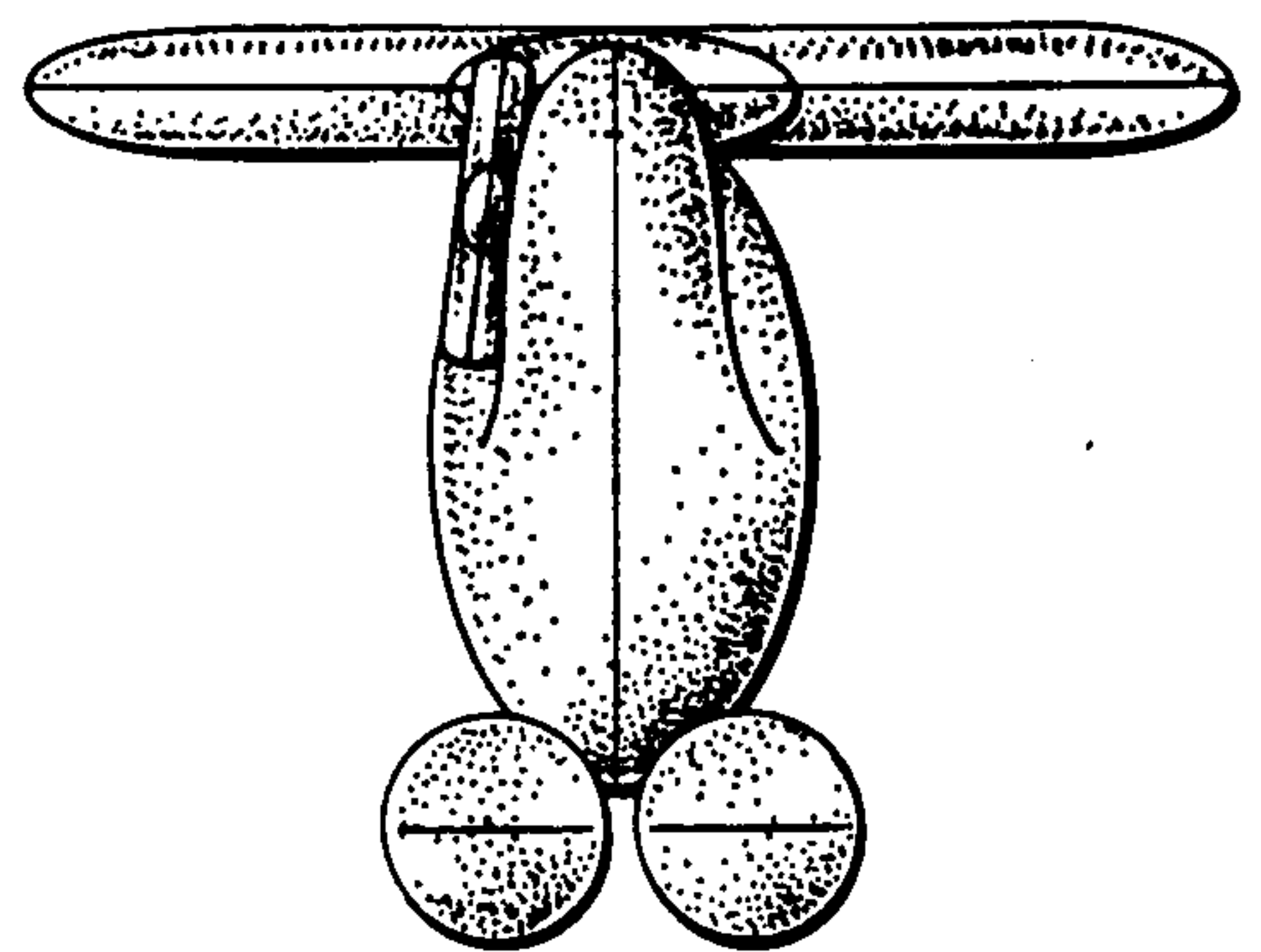

FIG. 12