

[54] RING BINDER

[75] Inventor: Heinz Witschi, Ortschwaben, Switzerland

[73] Assignee: Innotech AG, Schellenberg, Liechtenstein

[\*\*] Term: 14 Years

[21] Appl. No.: 298,094

[22] Filed: Jan. 18, 1989

[30] Foreign Application Priority Data

Jul. 20, 1988 [CH] Switzerland ..... 116902

[52] U.S. Cl. .... D19/27

[58] Field of Search ..... D18/7, 6, 11, 12, 2; D3/60, 30.1, 42, 52, 56; D19/26, 27, 28, 86, 32; 150/135, 152; 206/214, 215, 232; 281/22, 15.1, 16, 19.1, 29, 31

[56] References Cited

U.S. PATENT DOCUMENTS

- D. 265,989 8/1982 Harris et al. .... D3/30.1 X
- 976,166 11/1910 Gray ..... 206/215
- 1,426,657 8/1922 Long ..... 281/29
- 2,180,997 11/1939 Rubilino ..... 281/29 X
- 4,724,957 2/1988 Burgschweiger ..... 281/31 X

Primary Examiner—Wallace R. Burke  
Assistant Examiner—Pamela J. Schmidt  
Attorney, Agent, or Firm—Cushman, Darby & Cushman

[57] CLAIM

The ornamental design for a ring binder, as shown and described.

DESCRIPTION

FIG. 1 is an enlarged top perspective view of a ring binder showing my new design in an opened condition; FIG. 2 is a left side elevational view thereof in a closed condition (a right side elevational view being identical thereto);

FIG. 3 is a front elevational view thereof;

FIG. 4 is a rear elevational view thereof;

FIG. 5 is a top plan view thereof;

FIG. 6 is a bottom plan view thereof;

FIG. 7 is a perspective view thereof in a closed condition, showing the front, top and right side thereof; and FIG. 8 is a fragmentary perspective view thereof on a larger scale, showing the lower front portion depicted in FIG. 7.

The broken line showing of the binder element and sheet of paper in FIGS. 1 and 6 is for illustrative purposes only and forms no part of the claimed design.

The inside surface of the file holder as obscured by the sheet of paper is plain.

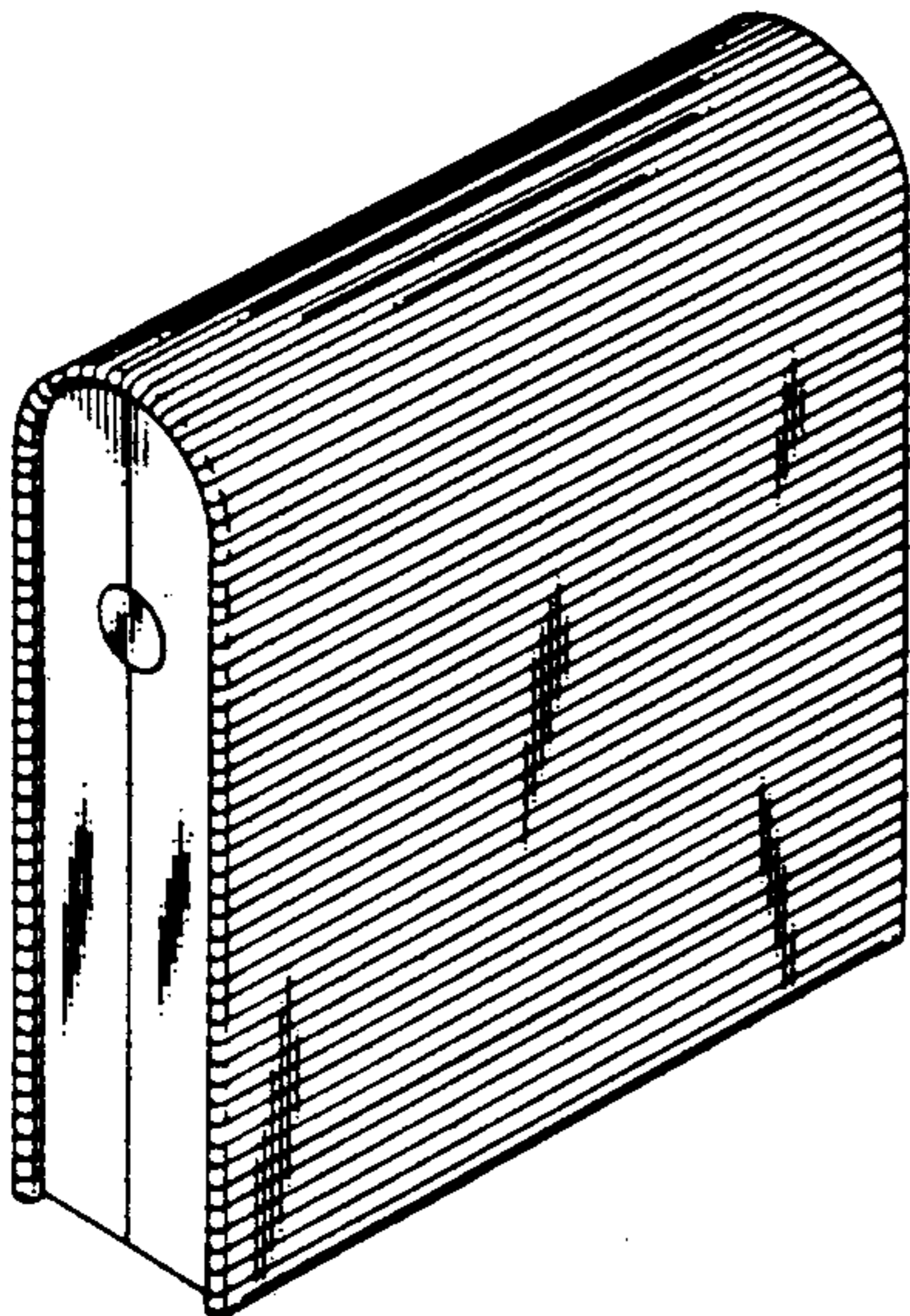
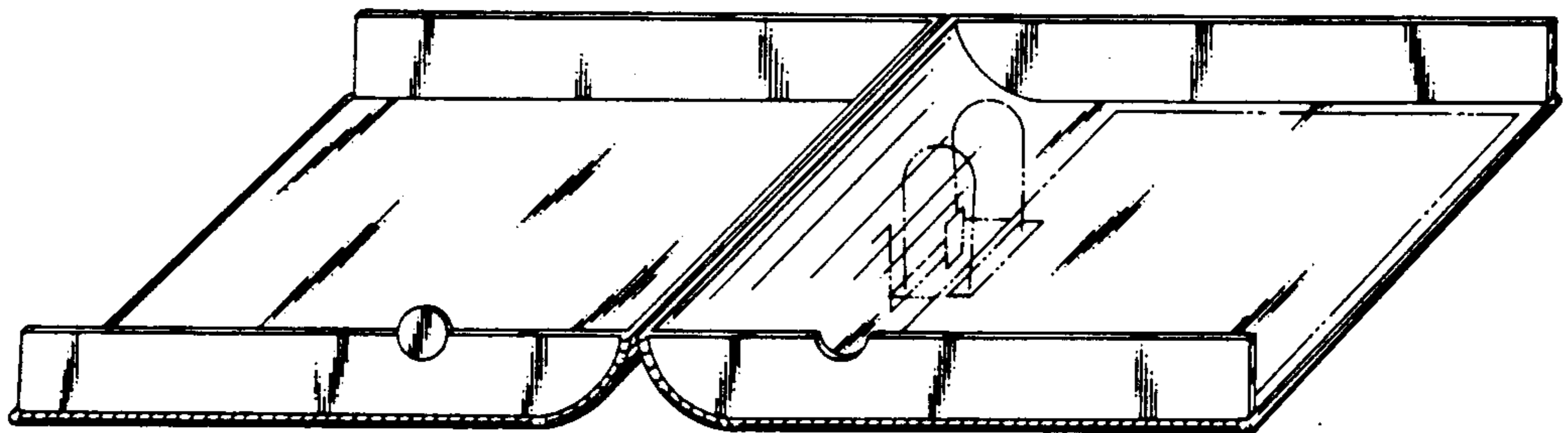

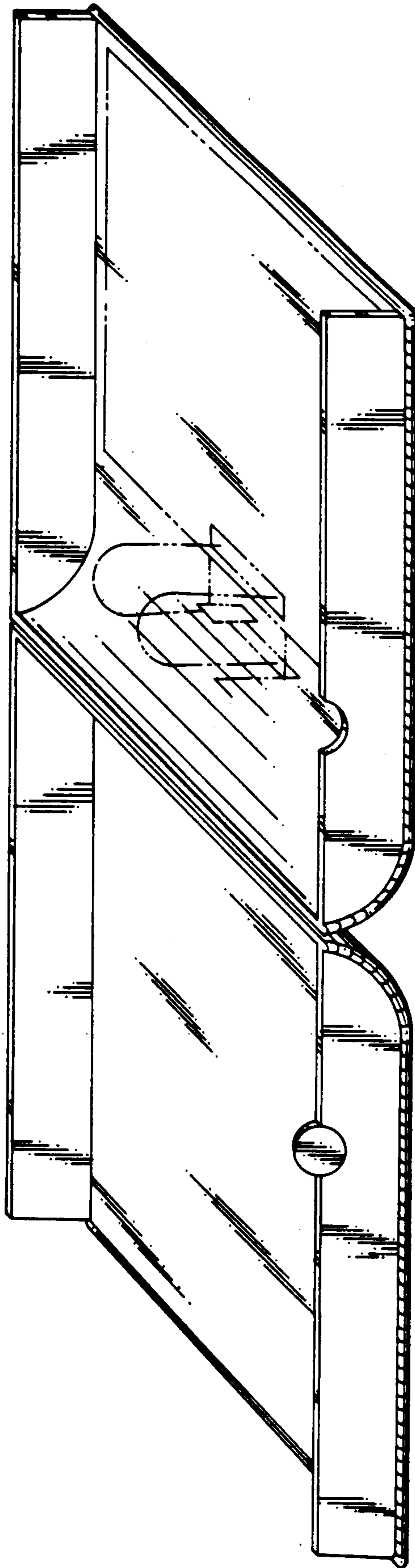

FIG. 1

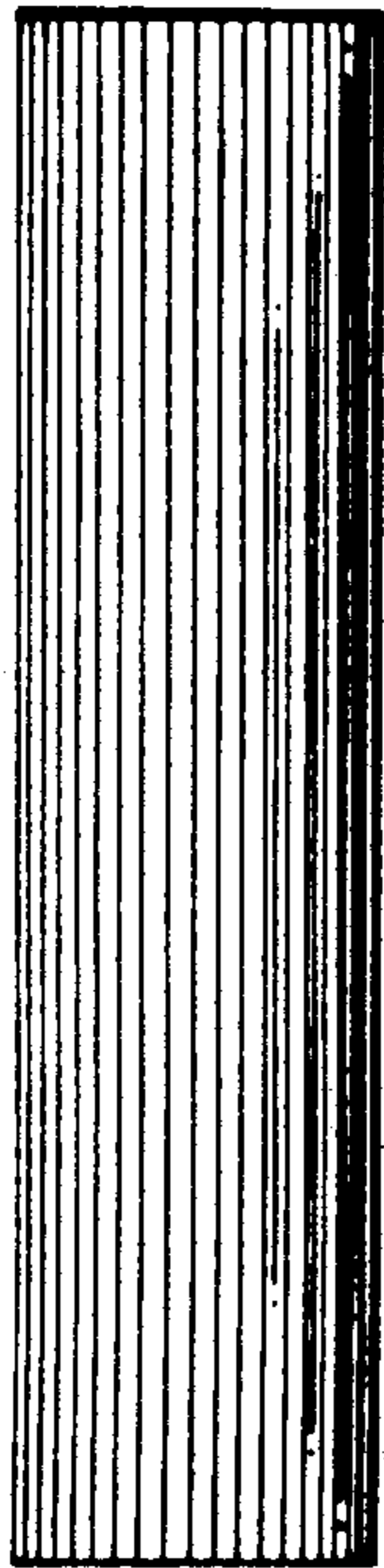

FIG. 5

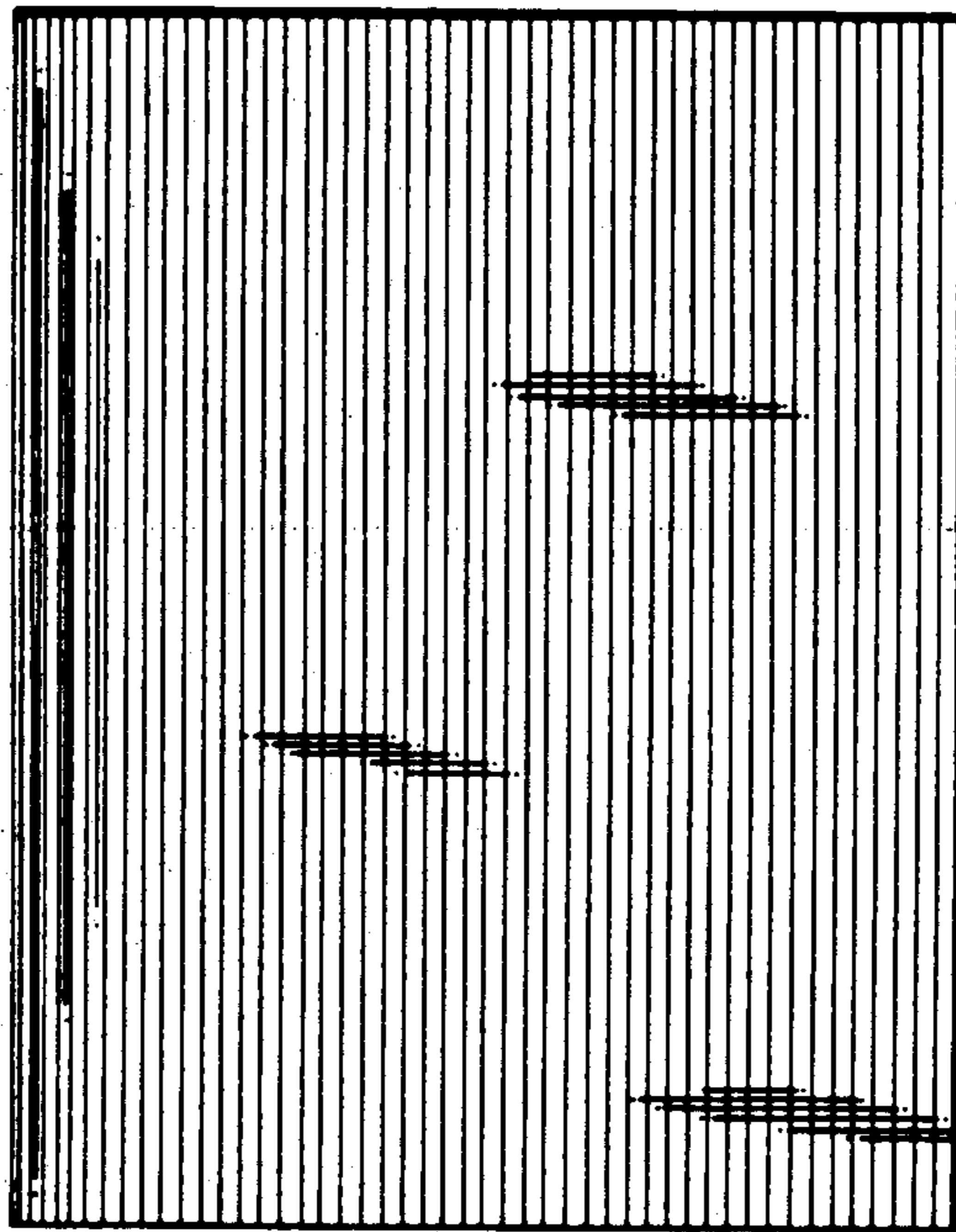

FIG. 2

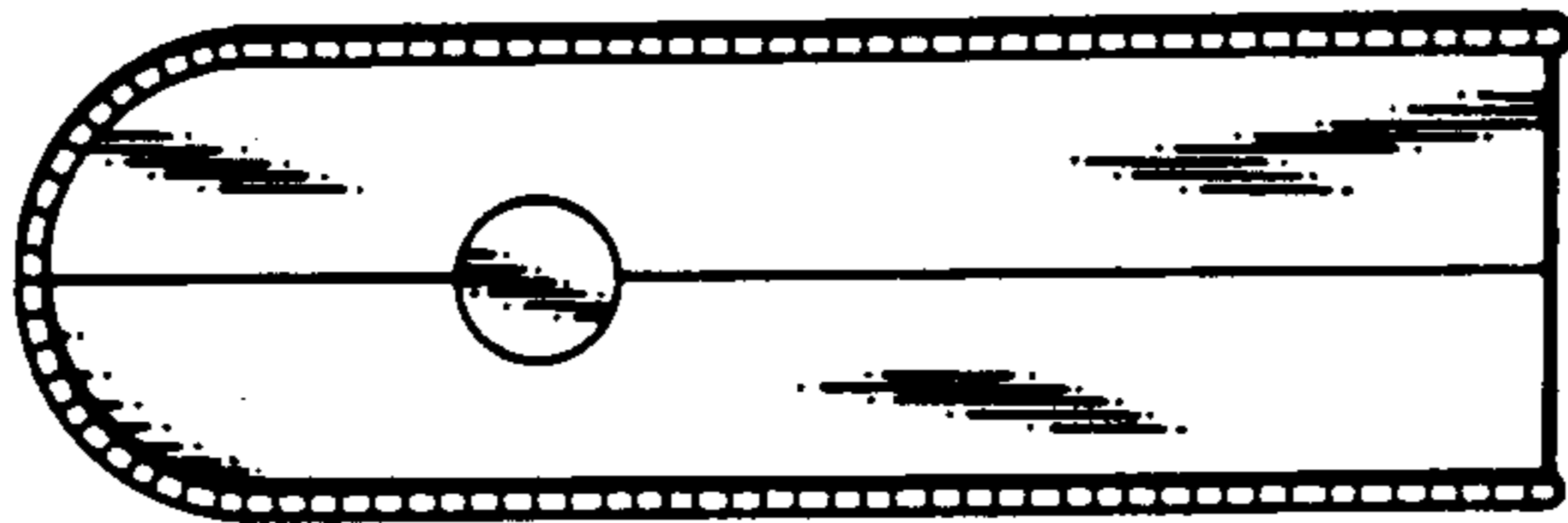

FIG. 3

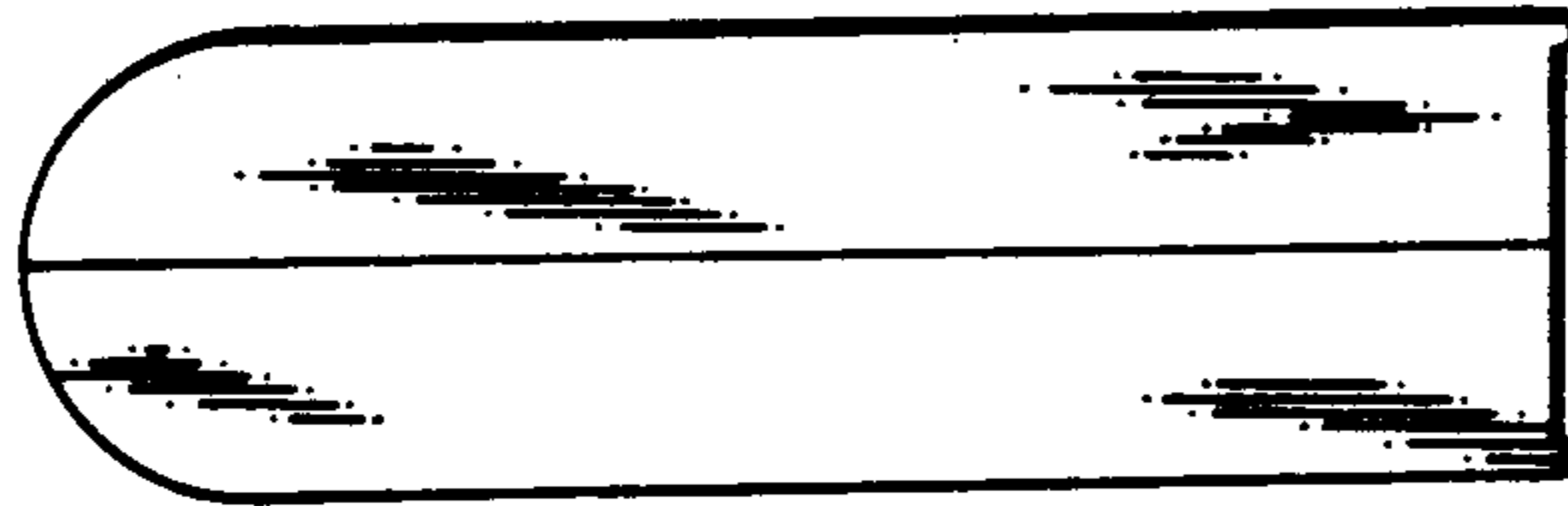

FIG. 4

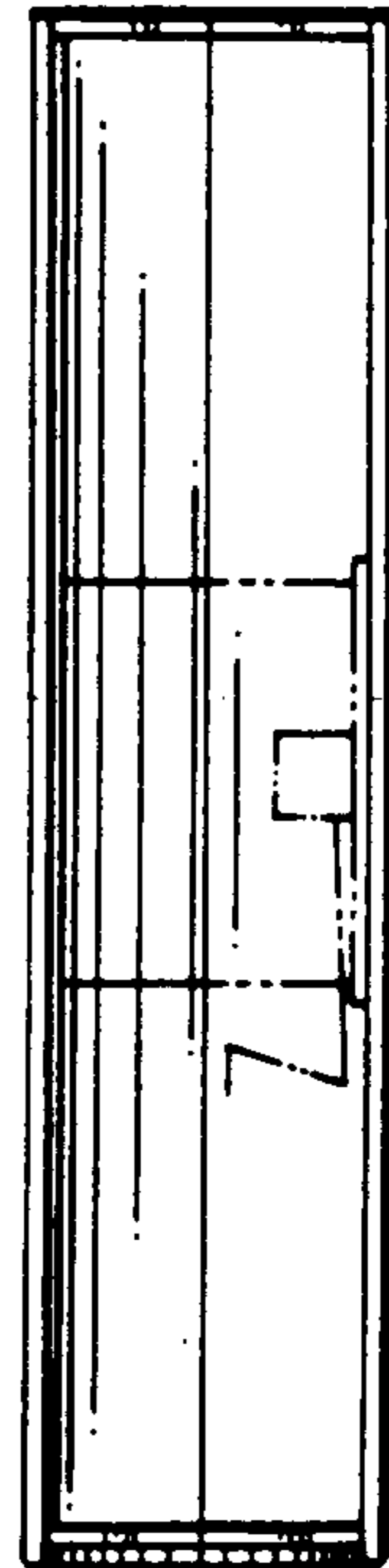

FIG. 6

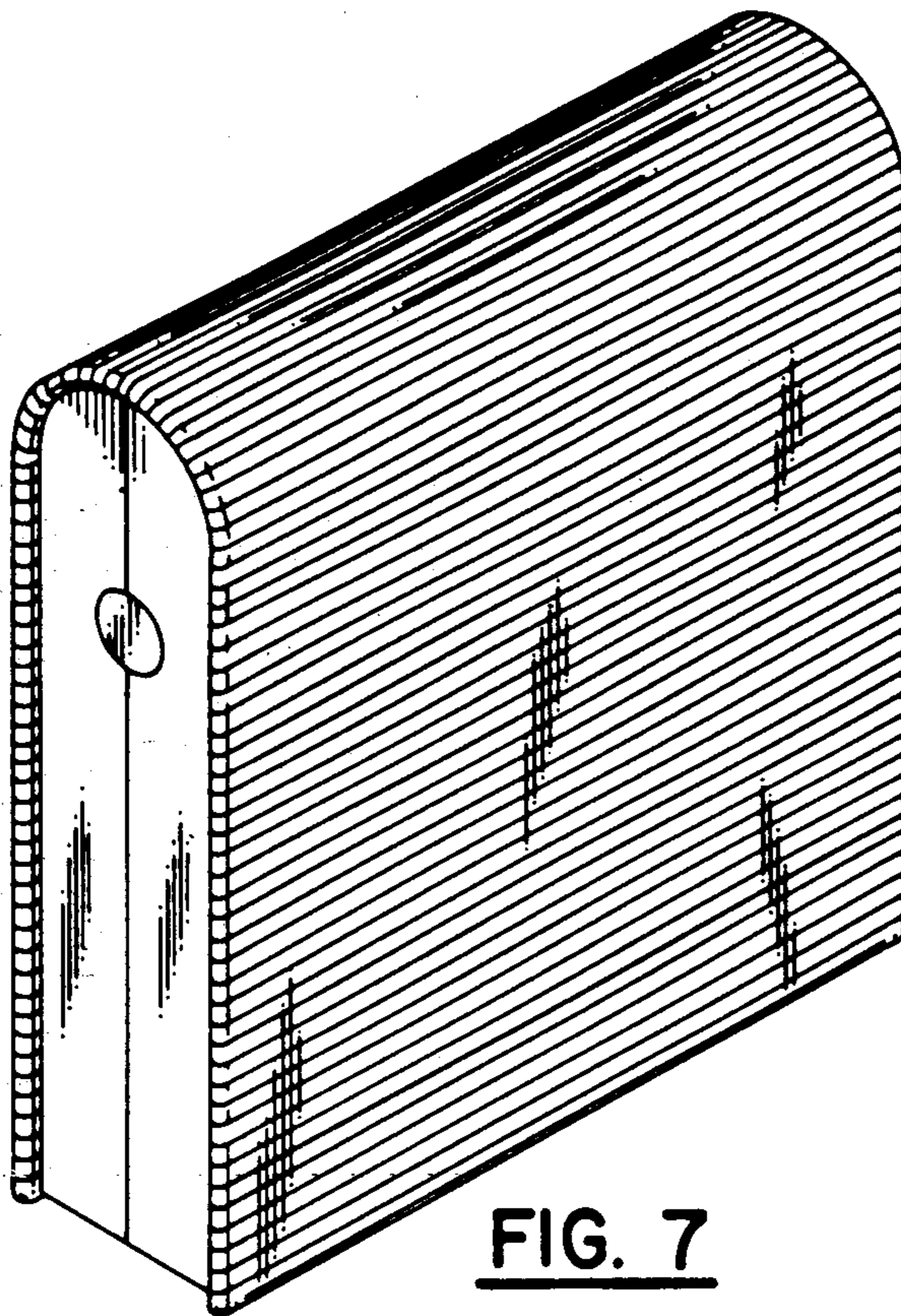

FIG. 7

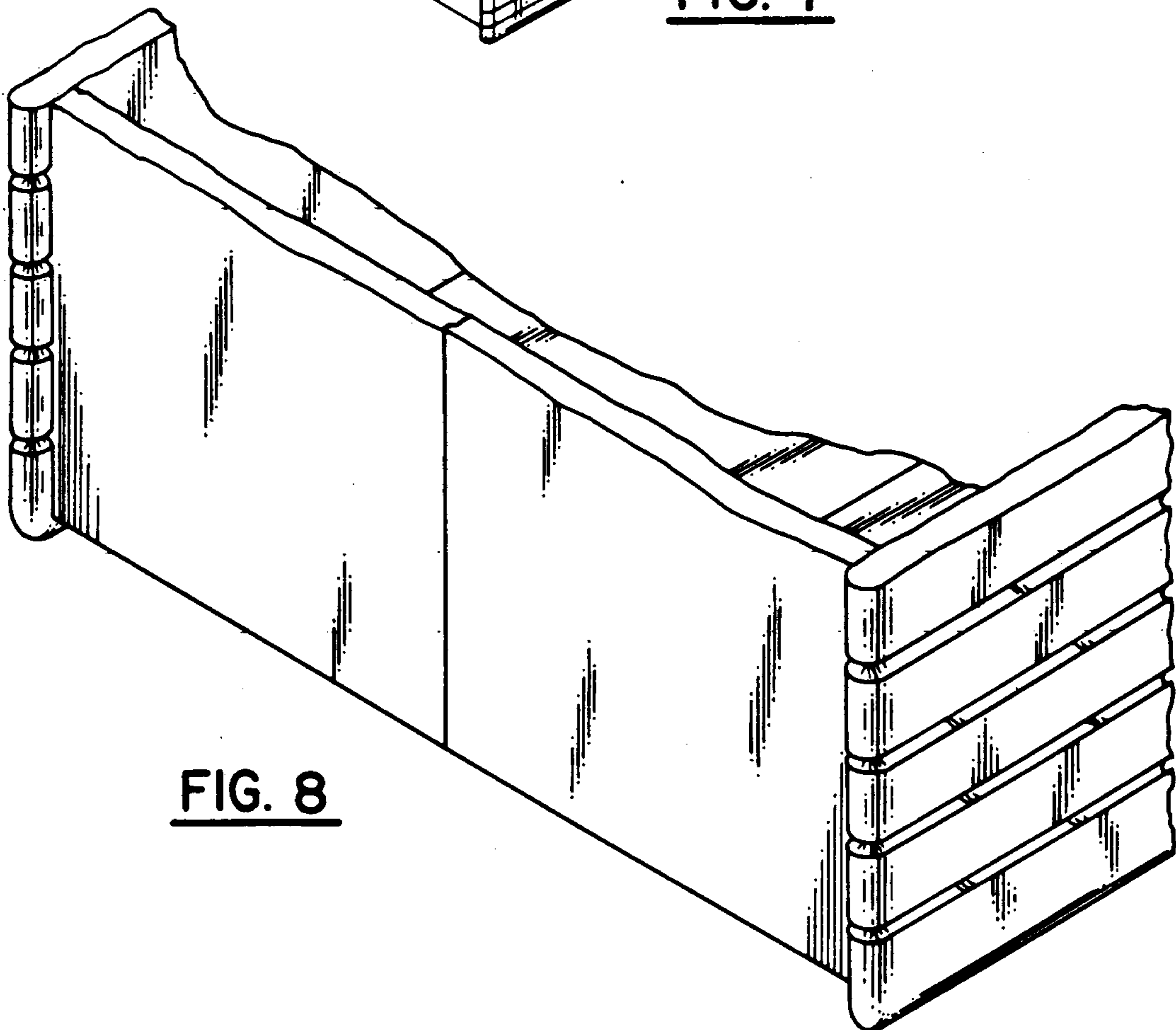

FIG. 8