

United States Patent [19]

Kistner

[11] Patent Number: **Des. 316,836**

[45] Date of Patent: **** May 14, 1991**

[54] **PLANTER**

[76] Inventor: **Theodore H. Kistner, 1757 Lorenzen Dr., San Jose, Calif. 95124**

[**] Term: **14 Years**

[21] Appl. No.: **329,699**

[22] Filed: **Mar. 28, 1989**

[52] U.S. Cl. **D11/156**

[58] Field of Search **D11/143, 155, 156; 47/66, 68, 79, 82, 41.13**

[56] **References Cited**

U.S. PATENT DOCUMENTS

D. 278,614	4/1985	Moss	D11/152
1,405,568	2/1922	Conklin	47/68
2,152,869	4/1939	Campbell	D11/152
2,261,326	11/1941	Atkisson et al.	47/41.13

4,255,896	3/1981	Carl	47/79
4,454,684	6/1984	O'Hare	47/82

Primary Examiner—B. J. Bullock
Attorney, Agent, or Firm—Henderson & Sturm

[57] **CLAIM**

The ornamental design for a planter, substantially as shown and described.

DESCRIPTION

FIG. 1 is a perspective view of a planter showing my new design;
FIG. 2 is a front elevational view, the rear being identical;
FIG. 3 is a top plan view;
FIG. 4 is an end elevational view, both ends being identical;
FIG. 5 is a bottom plan view.

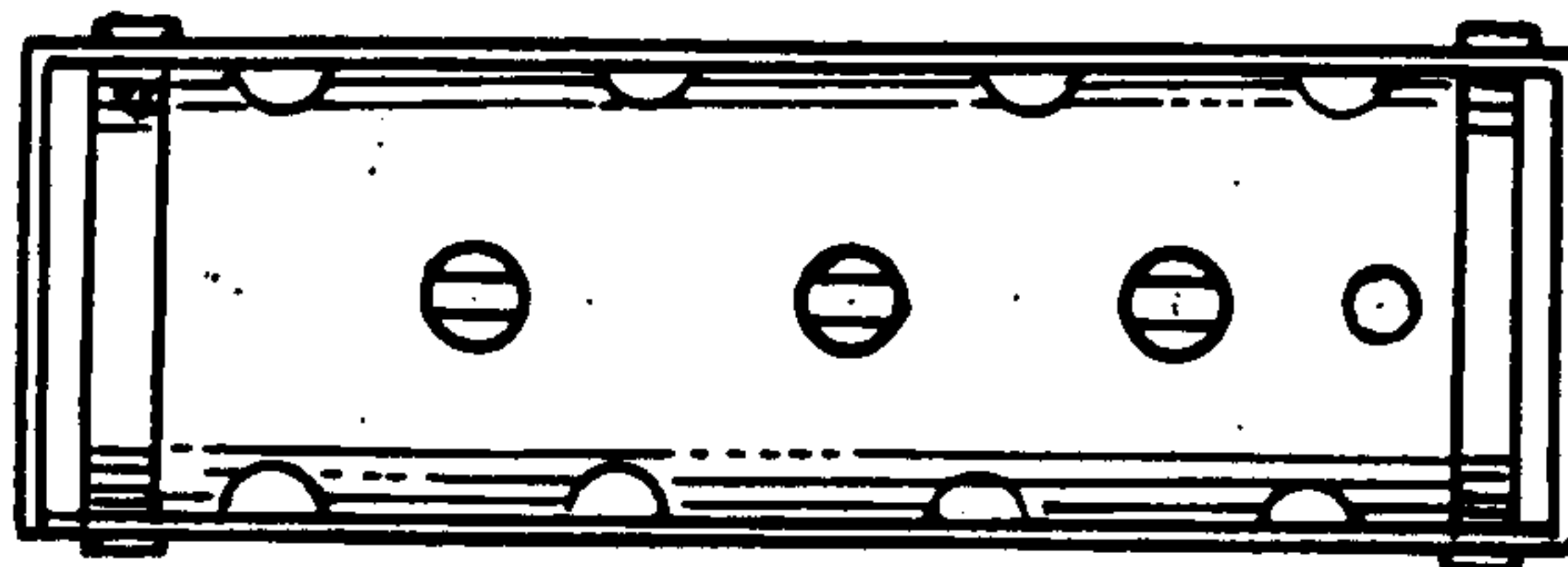
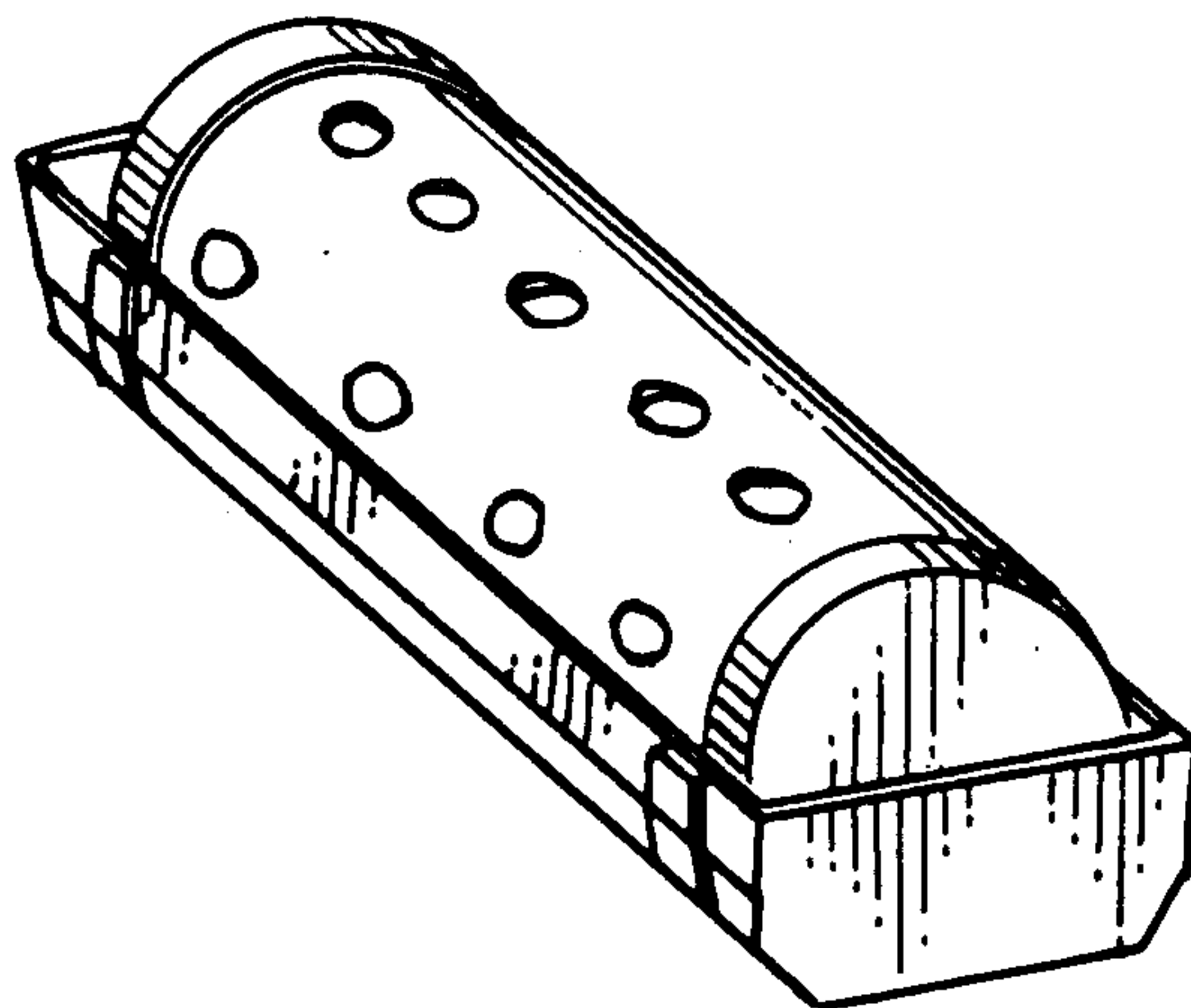

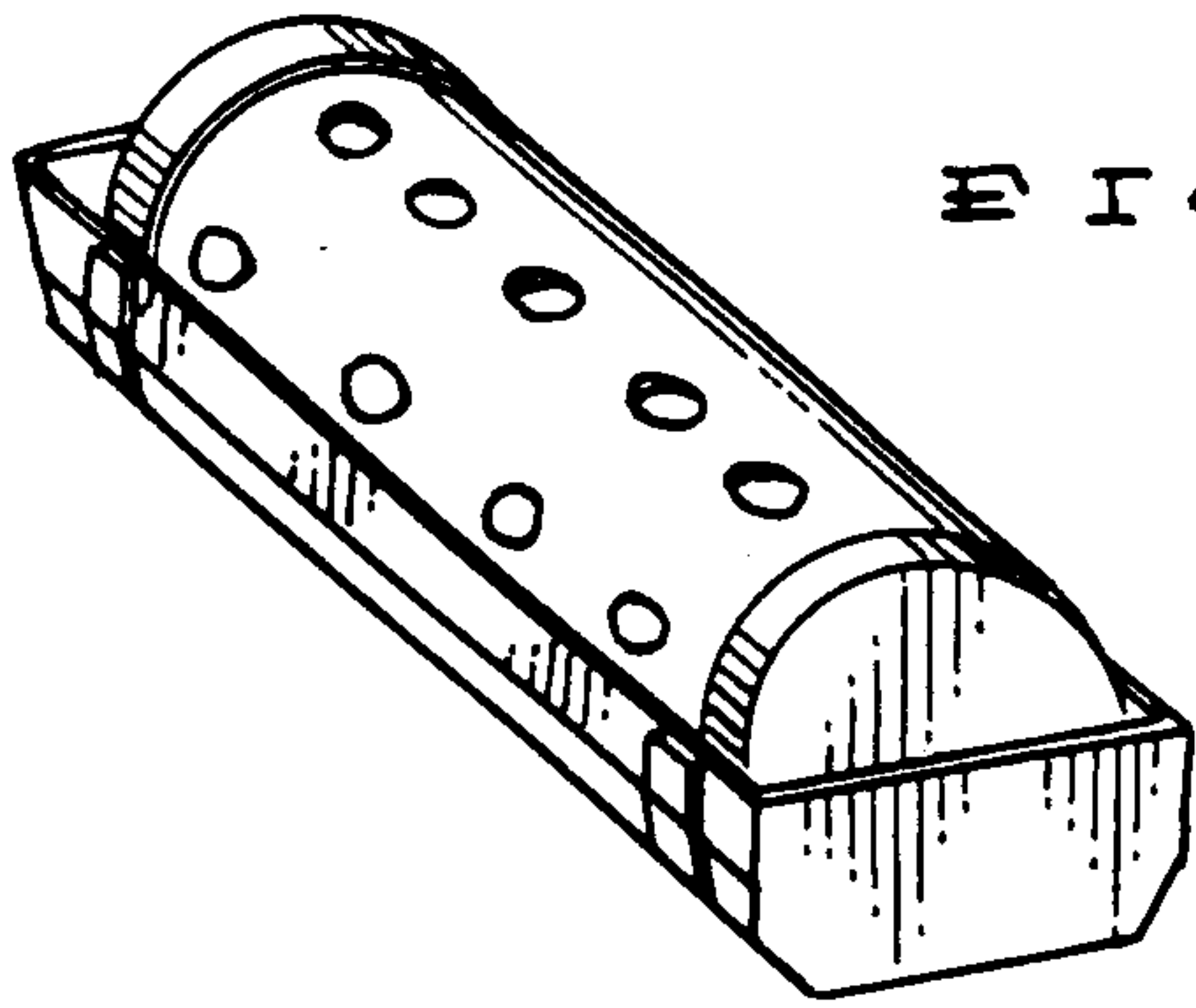

FIG. 1.

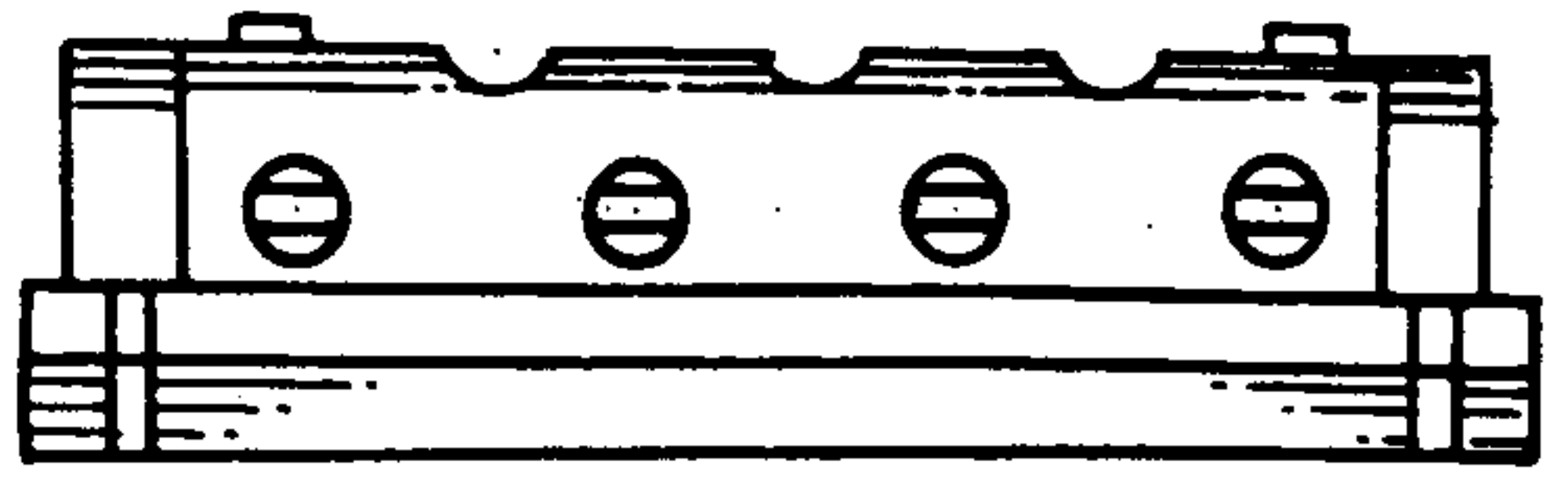

FIG. 2.

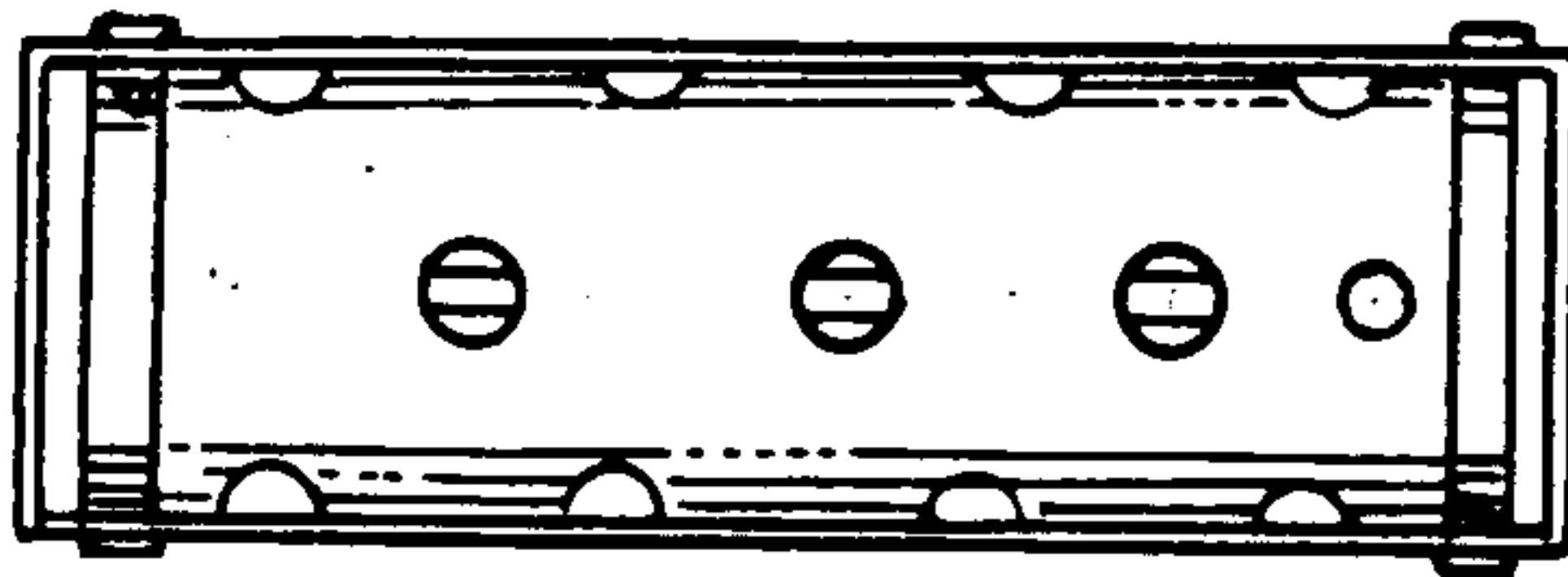

FIG. 3.

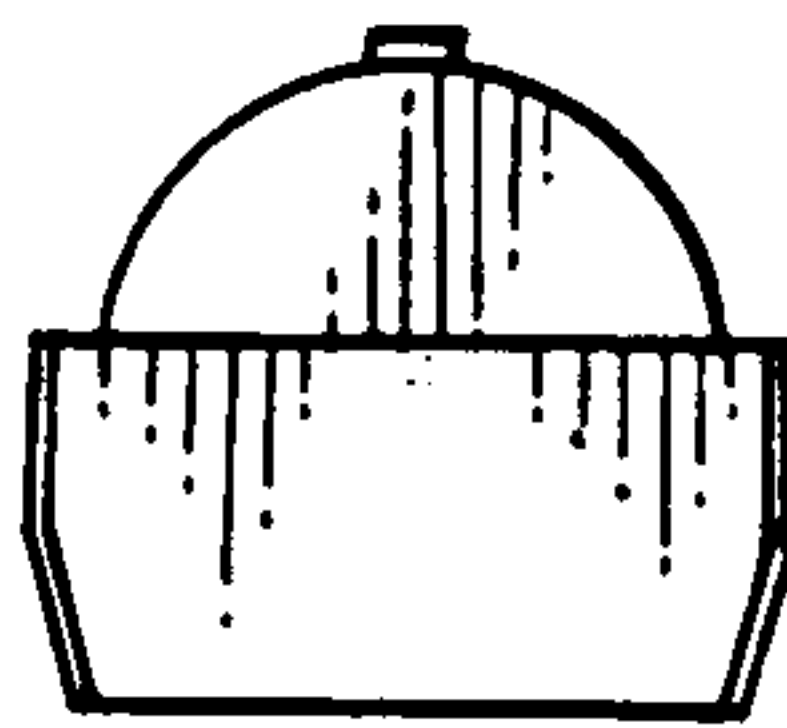

FIG. 4.

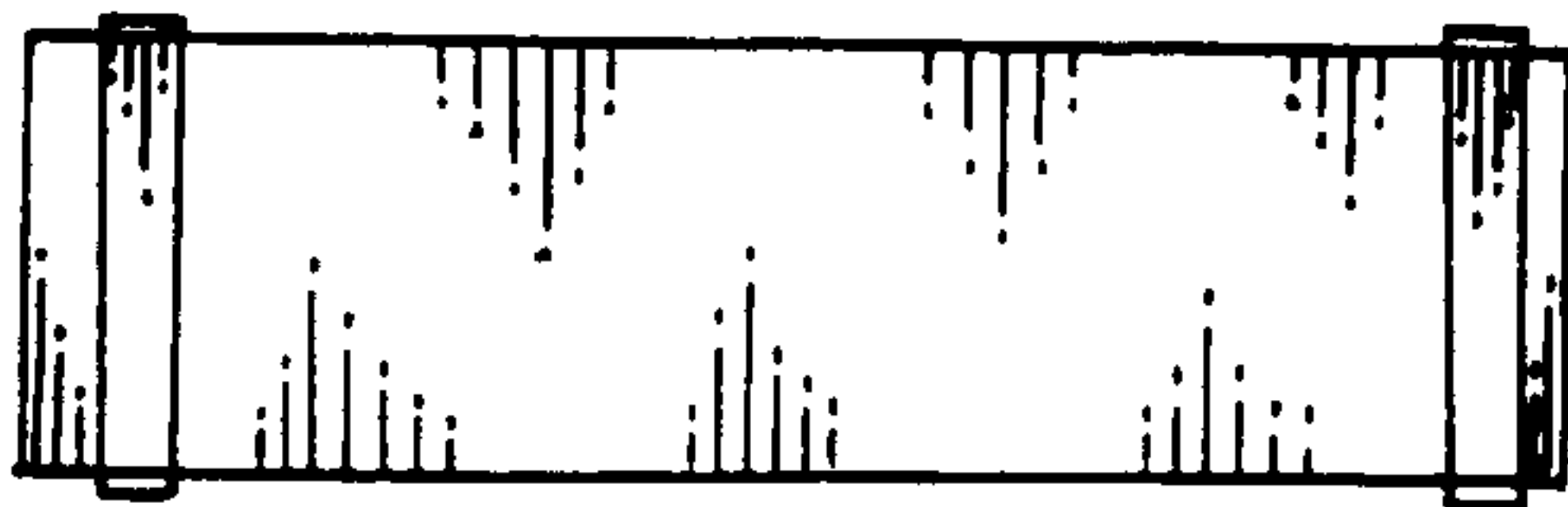

FIG. 5.