

[54] COMBINATION INFANT CAR SEAT NECK SUPPORT AND PACIFIER

[76] Inventor: Jill M. Manjarrez, 133 W. Olive, San Ysidro, Calif. 92073

[**] Term: 14 Years

[21] Appl. No.: 359,942

[22] Filed: Jun. 1, 1989

[52] U.S. Cl. D6/601

[58] Field of Search D6/595-596, D6/601, 604; D24/45-47, 34; 5/431, 434, 436, 437, 441, 445; 297/391, 393, 397

[56] References Cited

U.S. PATENT DOCUMENTS

- D. 33,613 11/1900 Hogan et al. D6/604
- D. 190,548 6/1961 Emery D6/604
- D. 255,966 7/1980 Stadel D6/604

- D. 295,558 3/1988 Jefferson et al. D6/34
- D. 300,694 4/1989 Krok D6/604
- D. 310,716 9/1990 Trask D6/34

Primary Examiner—Wallace R. Burke
Assistant Examiner—Brian N. Vinson
Attorney, Agent, or Firm—Jerry T. Kearns

[57] CLAIM

The ornamental design for an combination infant car seat neck support and pacifier, as shown and described.

DESCRIPTION

FIG. 1 is a front elevational view of an combination infant car seat neck support and pacifier showing my new design;
FIG. 2 is a rear elevational view thereof;
FIG. 3 is a left side elevational view thereof;
FIG. 4 is a right side elevational view thereof;
FIG. 5 is a top plan view thereof; and,
FIG. 6 is a bottom plan view thereof.

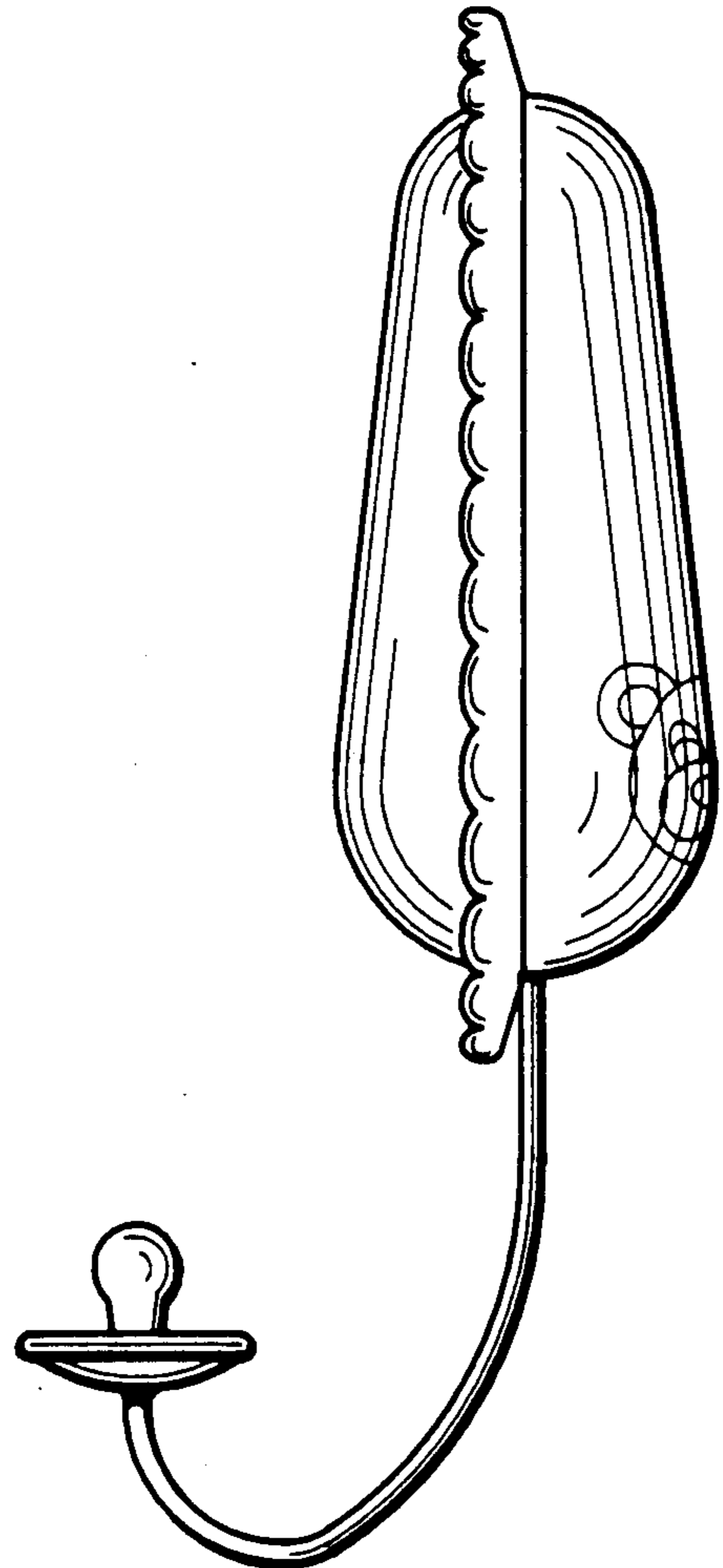
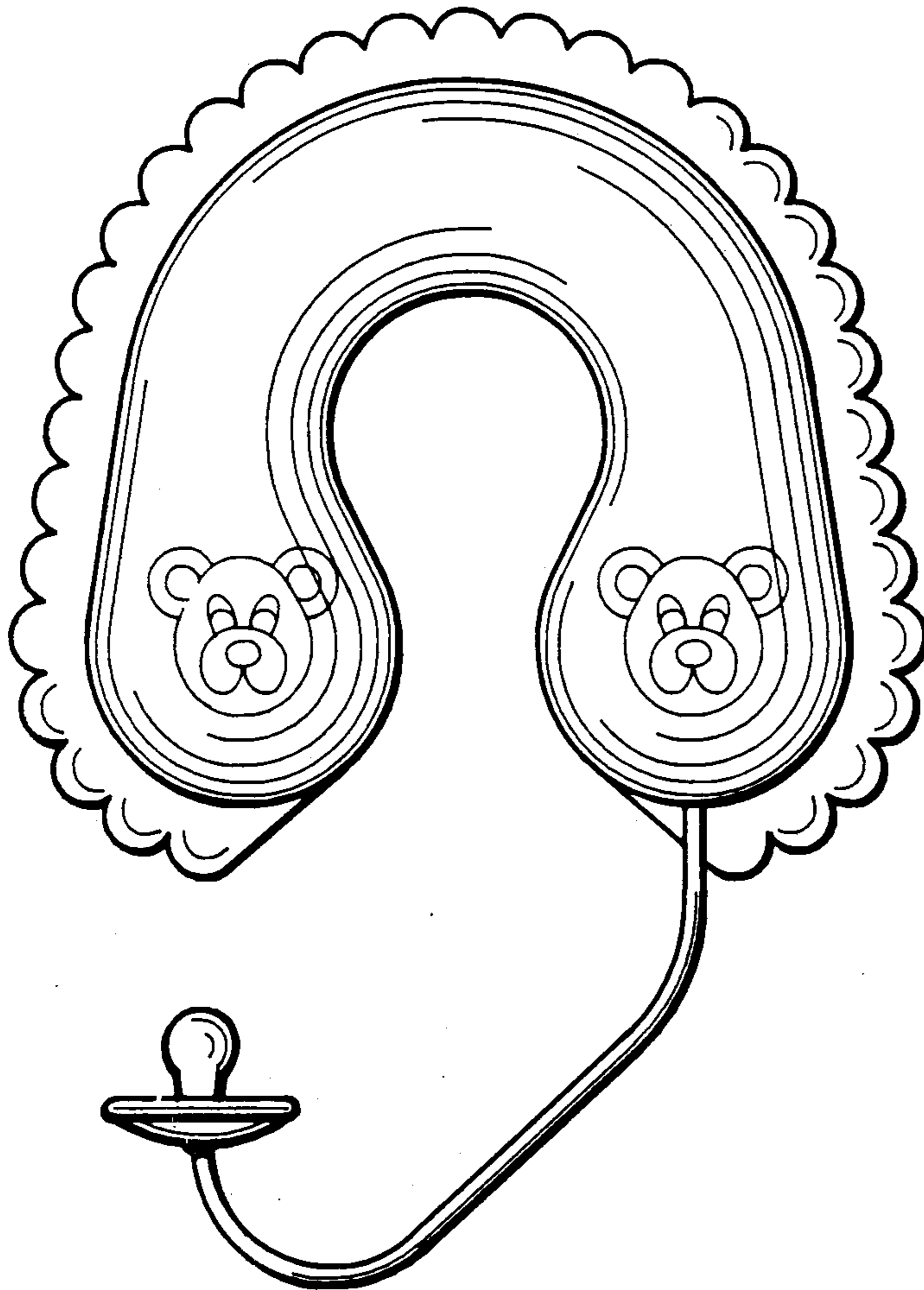

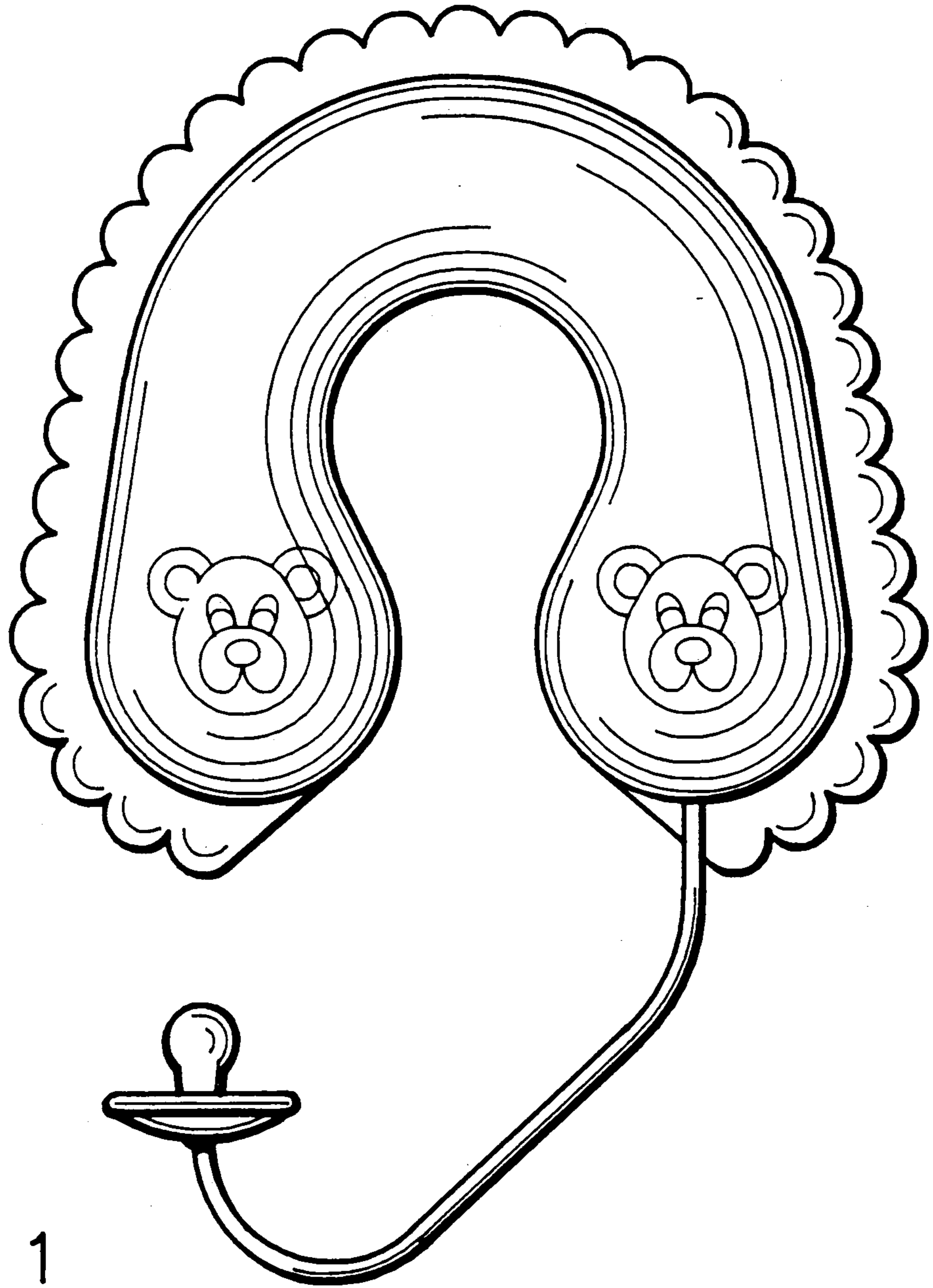

Fig. 1

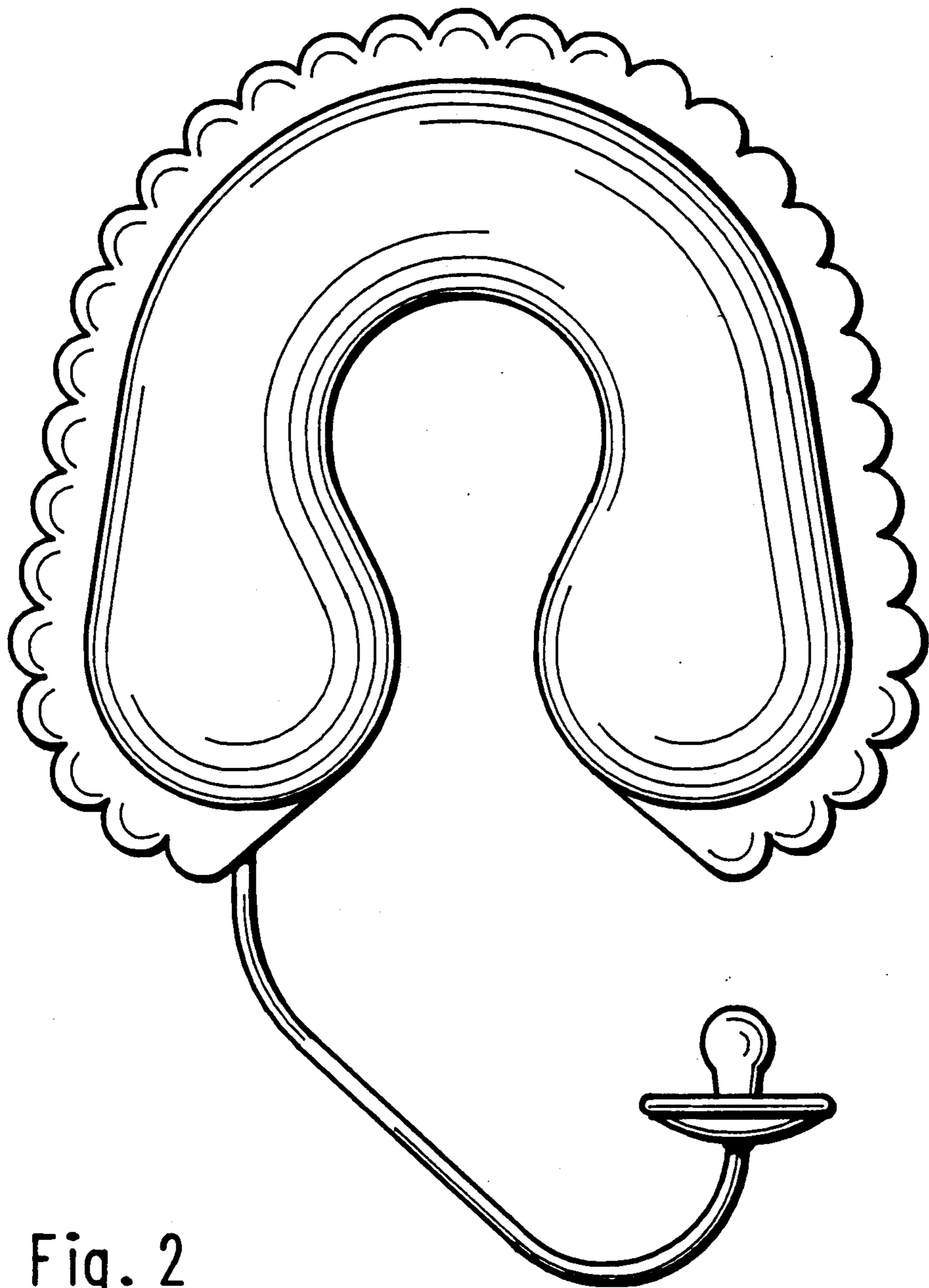

Fig. 2

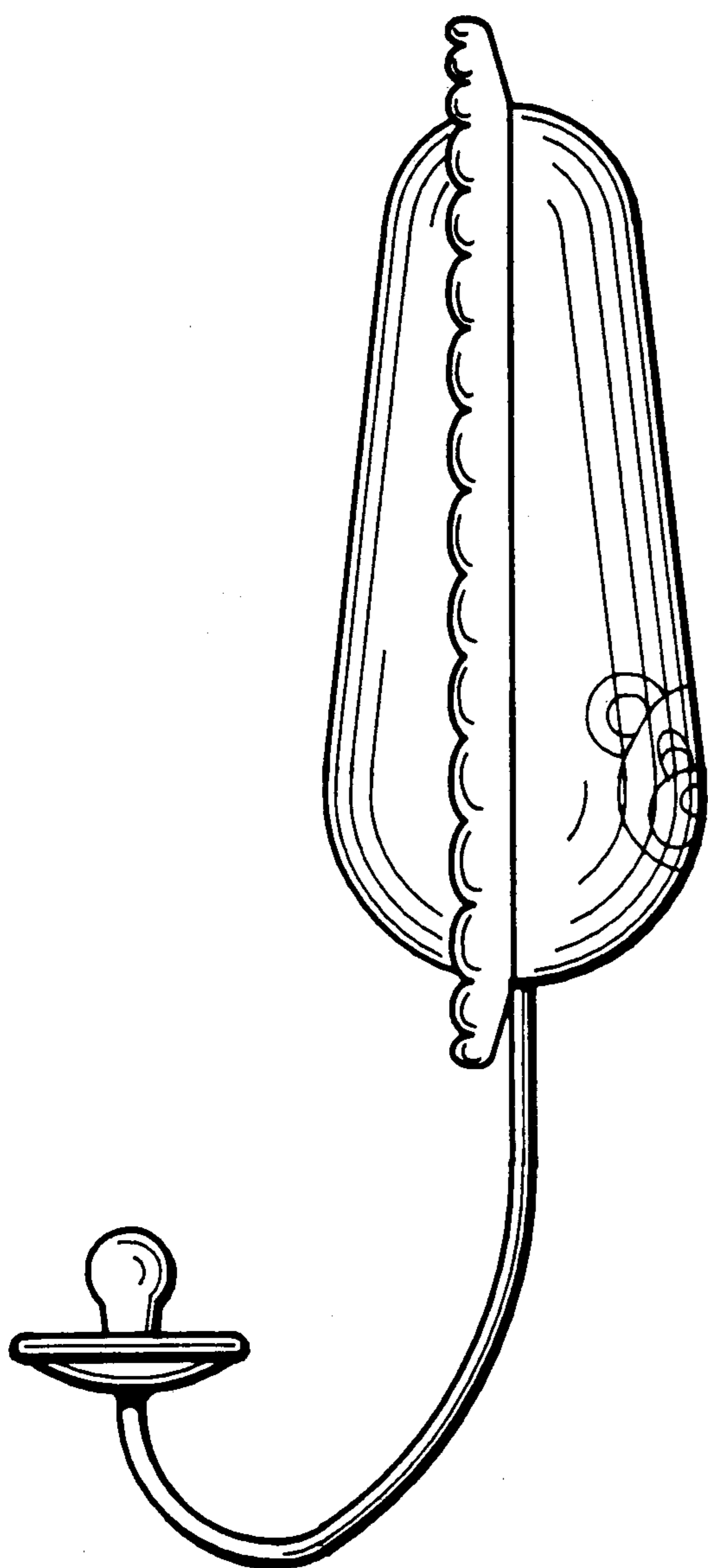

Fig. 3

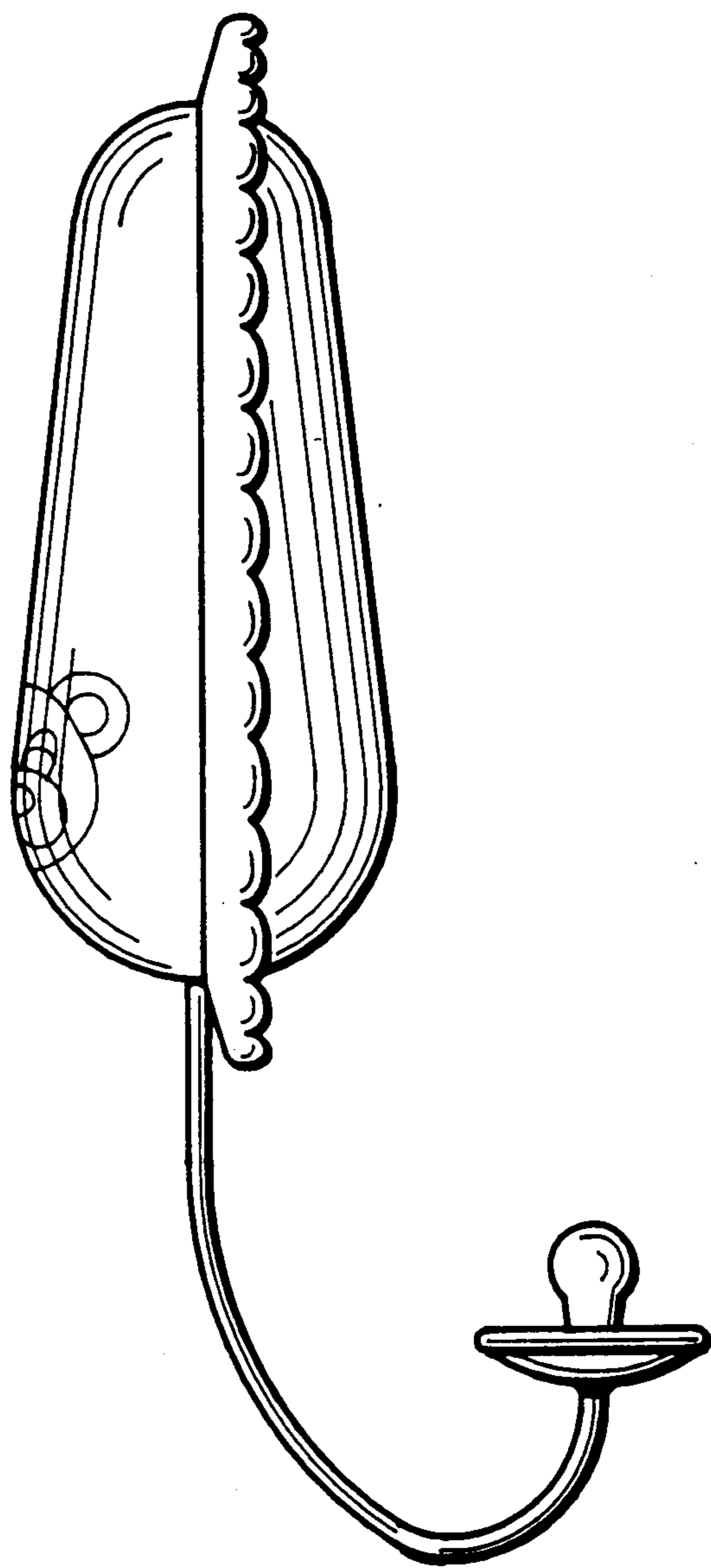

Fig. 4

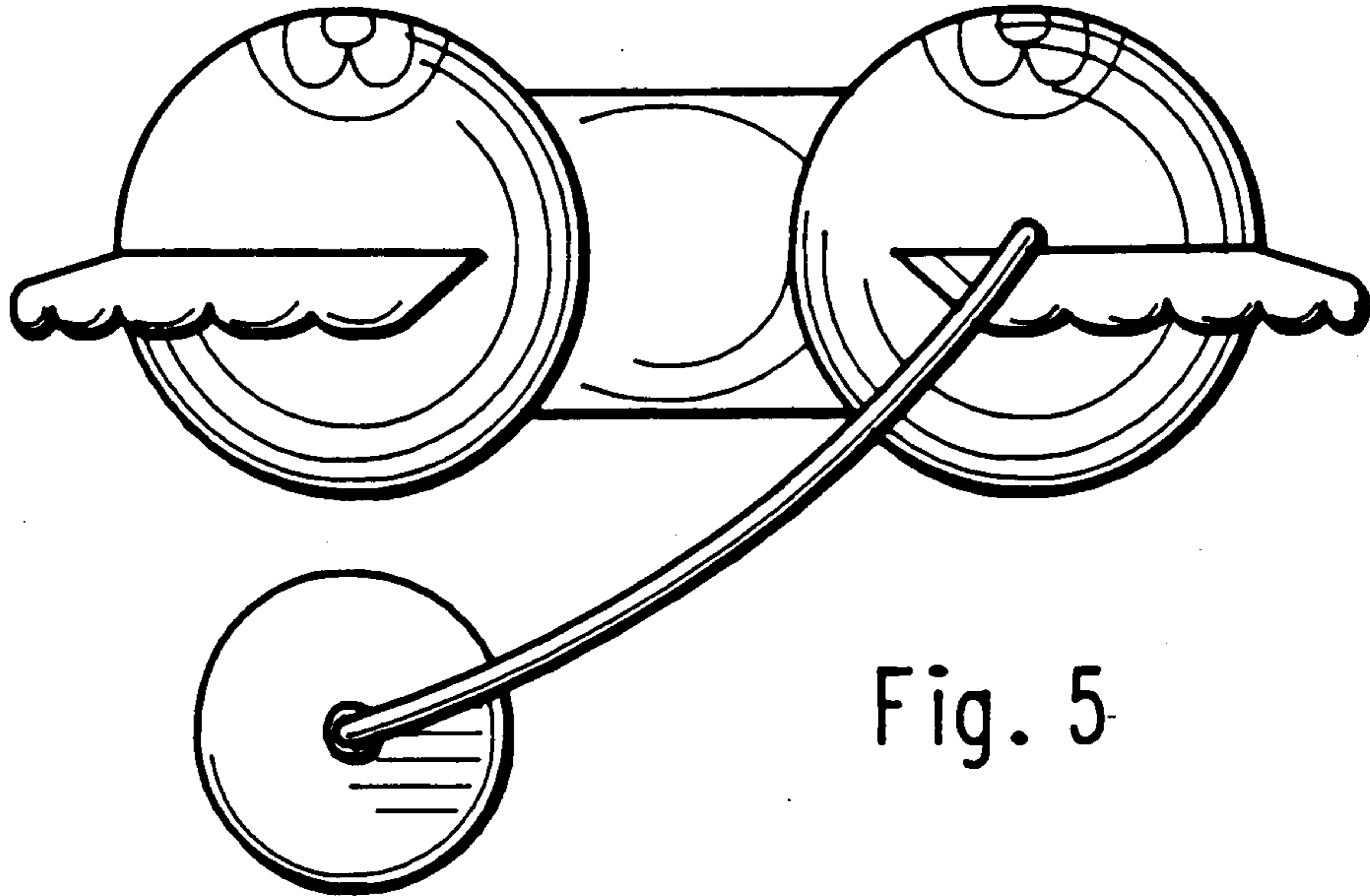

Fig. 5

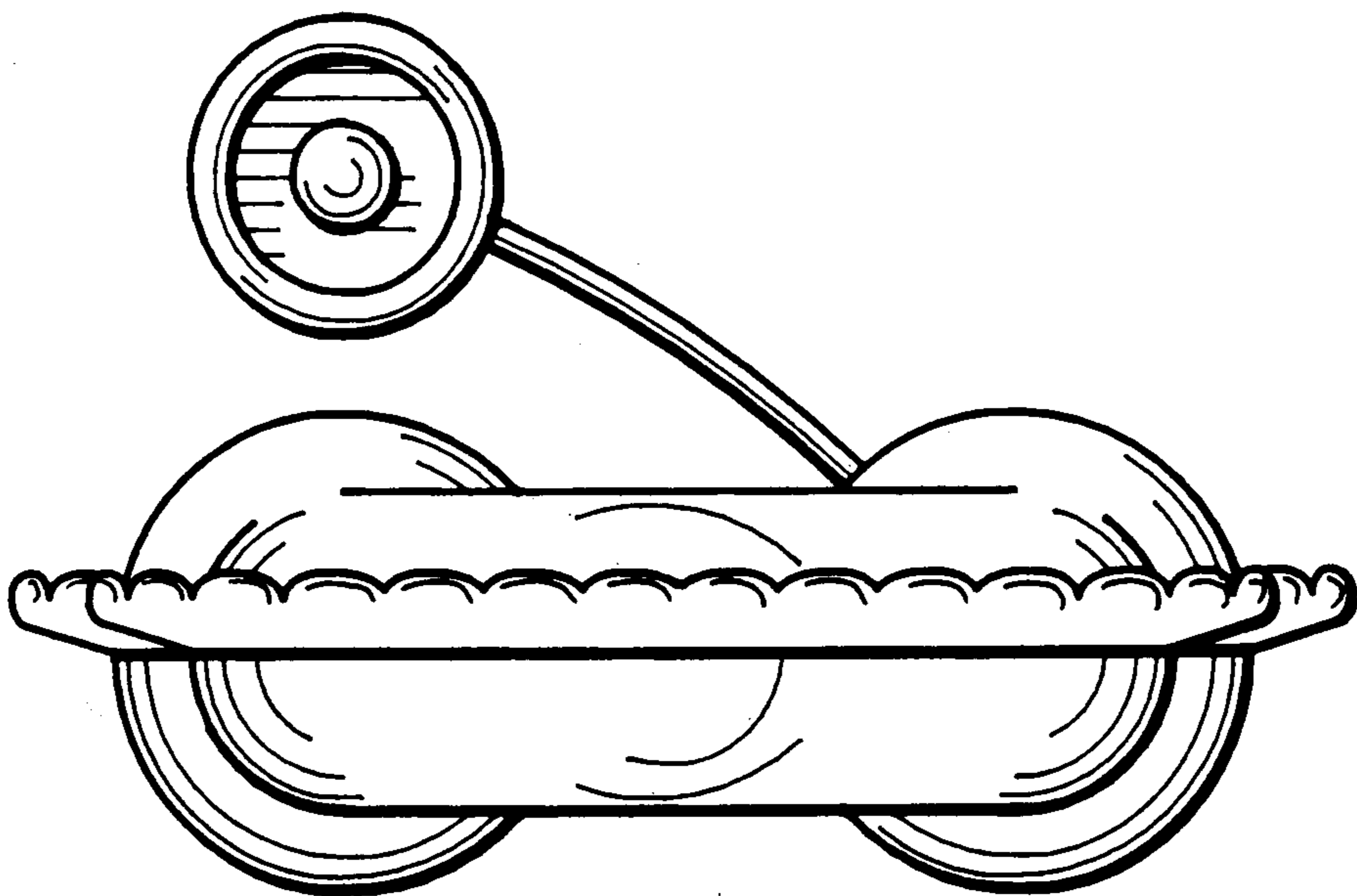

Fig. 6