

[54] SPRINKLER

[75] Inventor: Franco Clivio, Zürich, Switzerland

[73] Assignee: Gardena Kress + Kastner GmbH,
Fed. Rep. of Germany

[**] Term: 14 Years

[21] Appl. No.: 390,675

[22] Filed: Aug. 7, 1989

[52] U.S. Cl. D23/218

[58] Field of Search D23/200, 211, 213-221;
239/200-207, 211, 242-243, 246-248, 273,
275-276, 279-280, 390-394, 443-444, 456,
556-558, DIG. 1

[56] References Cited

U.S. PATENT DOCUMENTS

2,050,659	8/1936	Knuth	239/204
2,968,440	1/1961	Cone	239/203
4,562,962	1/1986	Hartman	239/200
4,625,914	12/1986	Sexton et al.	239/206

OTHER PUBLICATIONS

Wettbewerb Getriebe-Versenkregner (1 pg.).
Gardena Sprinkler-System (1 pg.).

Primary Examiner—Susan J. Lucas
Assistant Examiner—M. H. Tung
Attorney, Agent, or Firm—Eckert Seamans Cherin &
Mellott

[57] CLAIM

The ornamental design for a sprinkler, as shown and described.

DESCRIPTION

FIG. 1 is a side perspective view of a sprinkler showing my new design;
FIG. 2 is a top plan view thereof;
FIG. 3 is a side elevational view thereof;
FIG. 4 is a front elevational view thereof;
FIG. 5 is the opposite side elevational view thereof;
FIG. 6 is a rear elevational view thereof;
FIG. 7 is a bottom plan view thereof; and
FIG. 8 is a side perspective view thereof, the top shown in extended position.

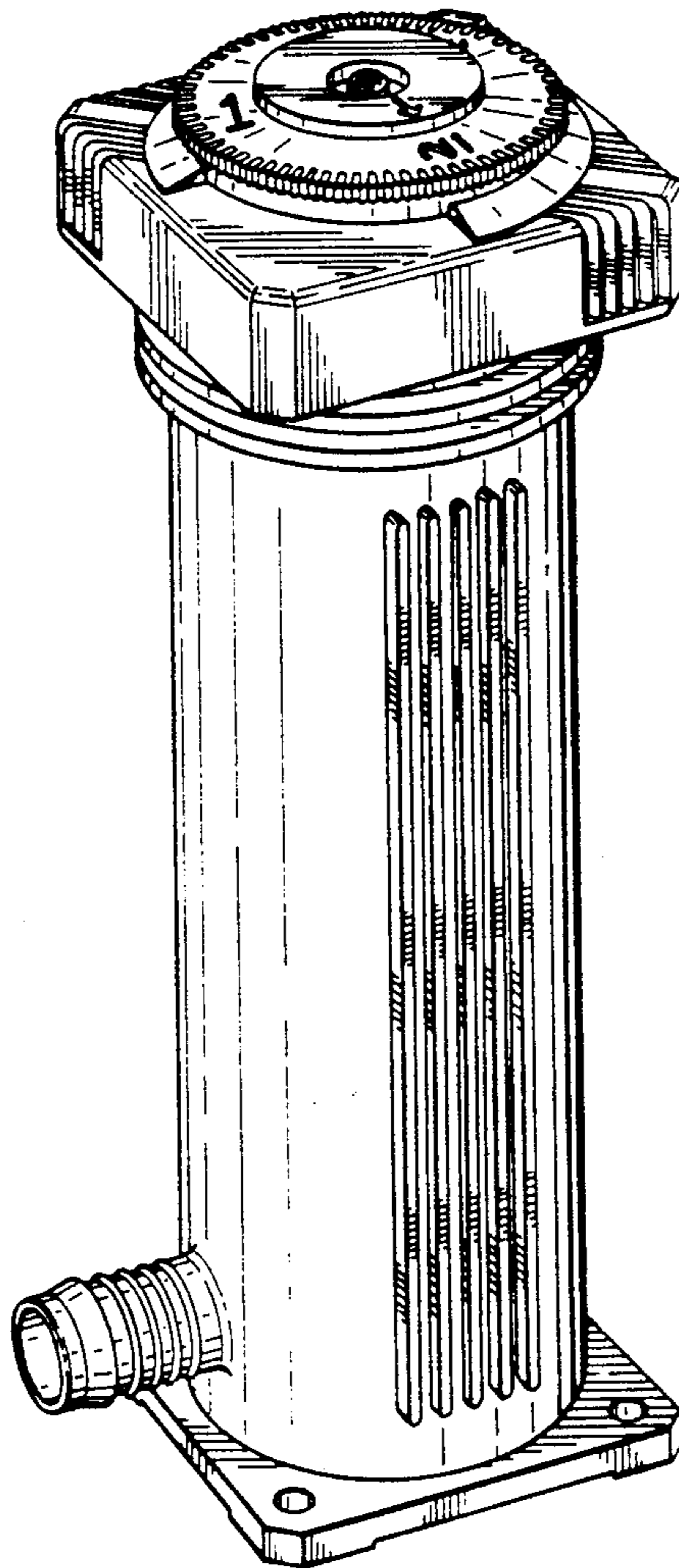
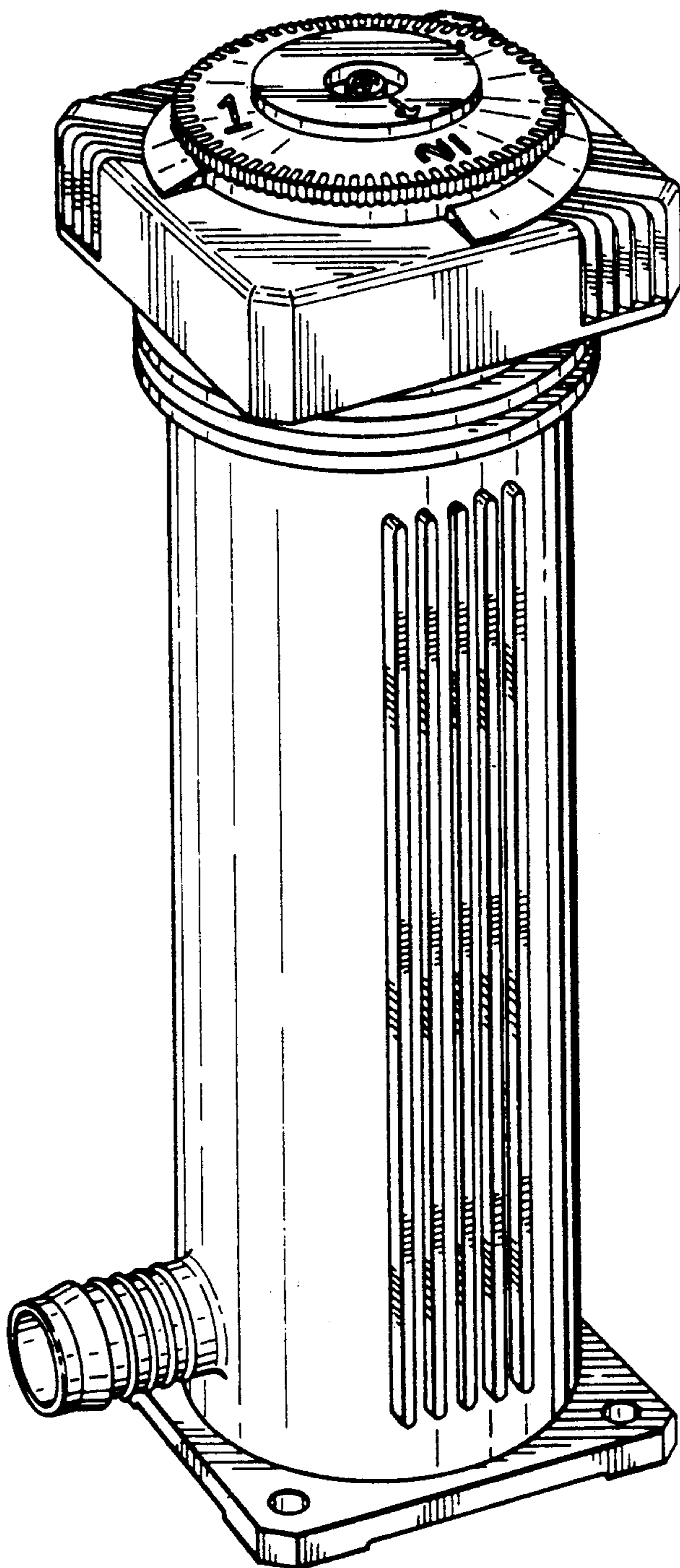

FIG. 1



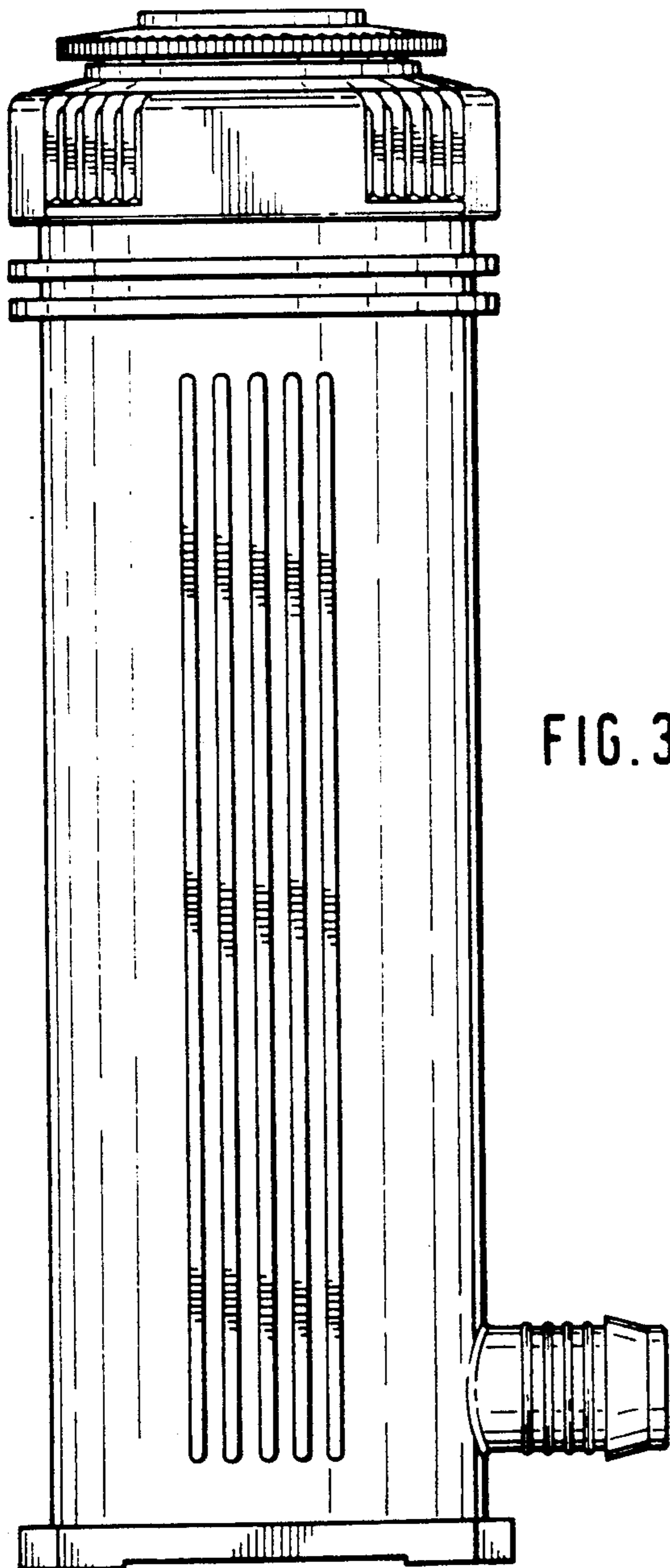
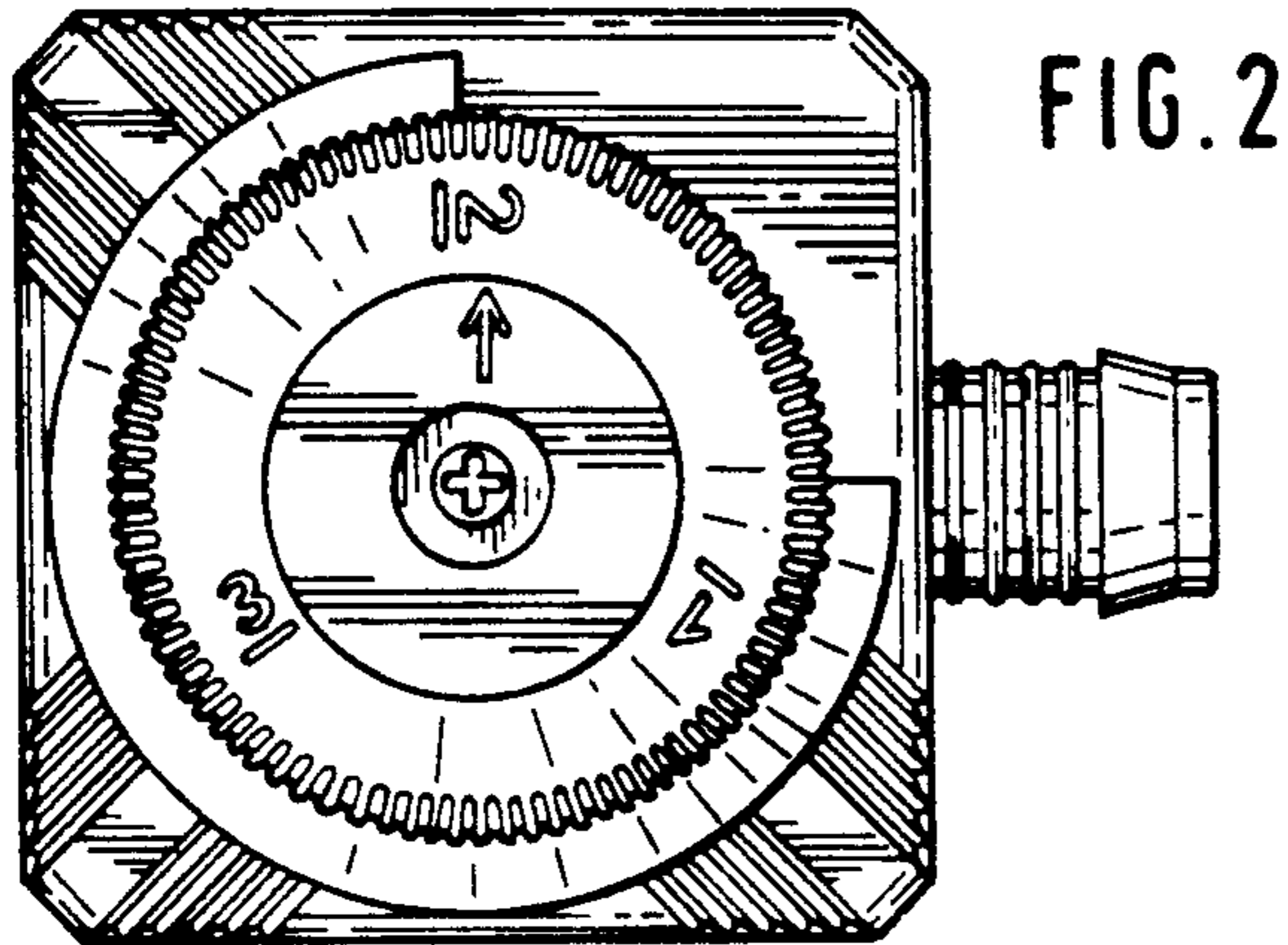
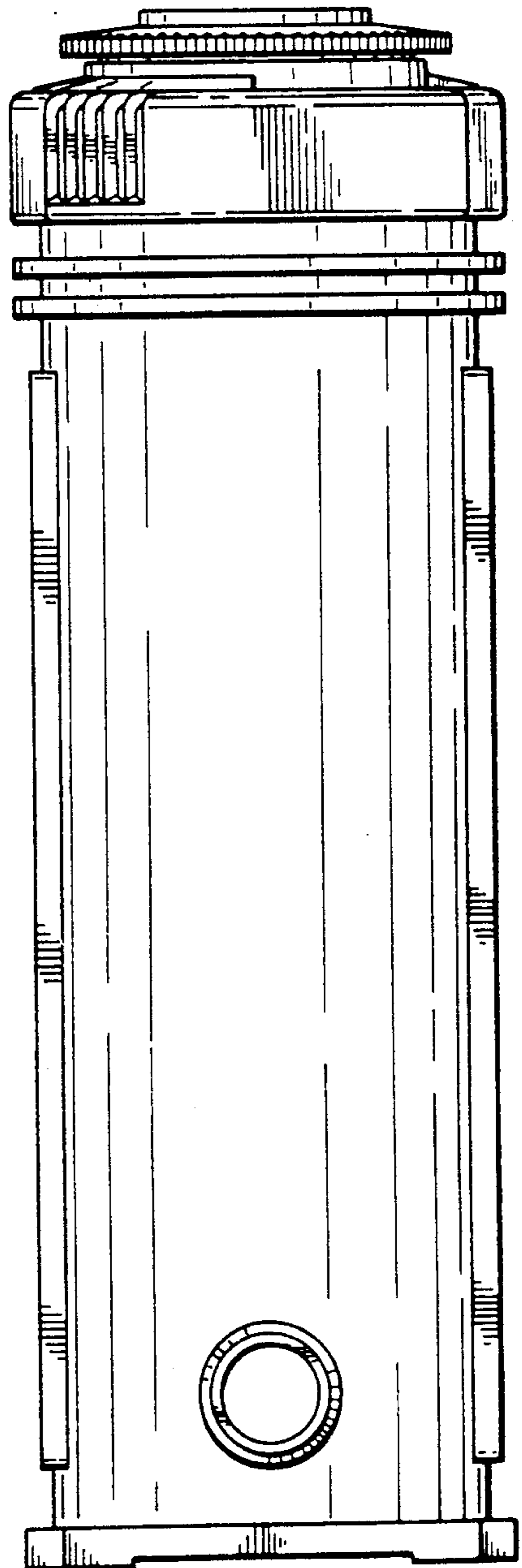

FIG. 4



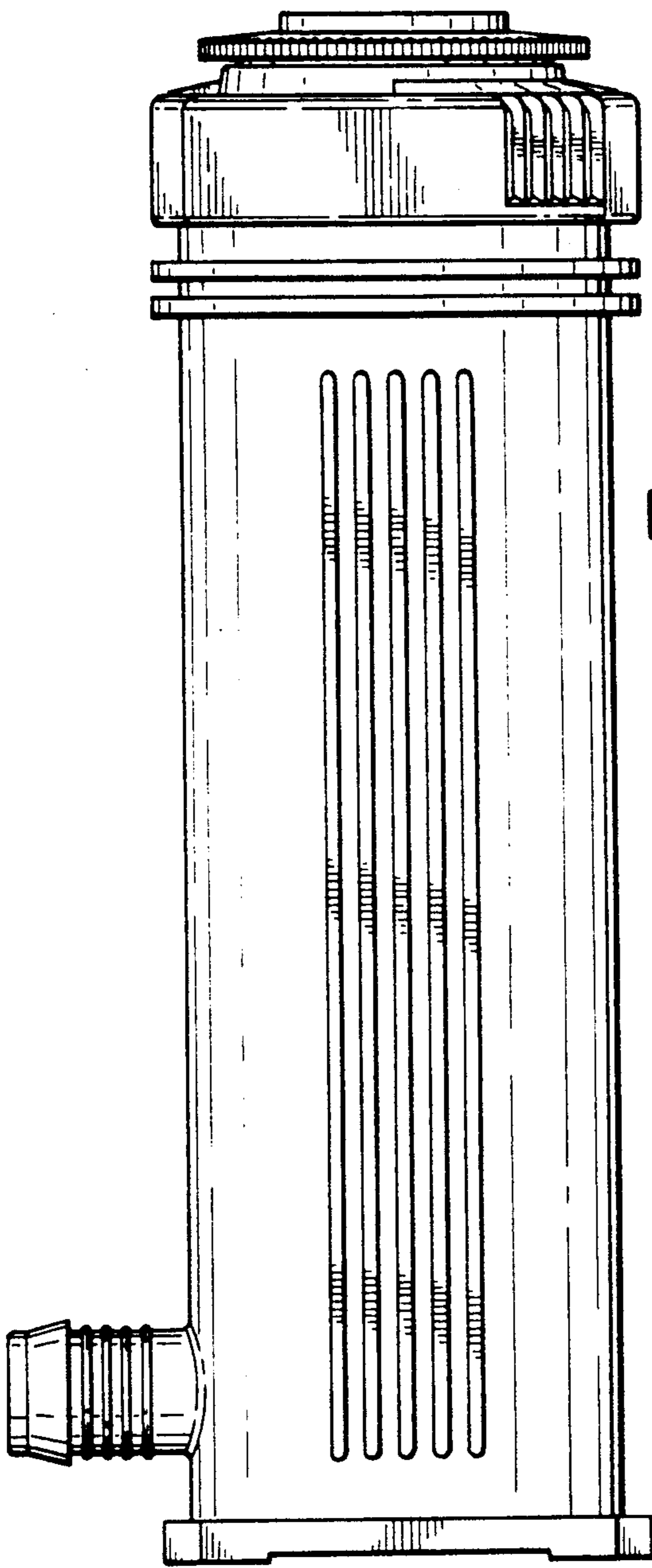

FIG. 5

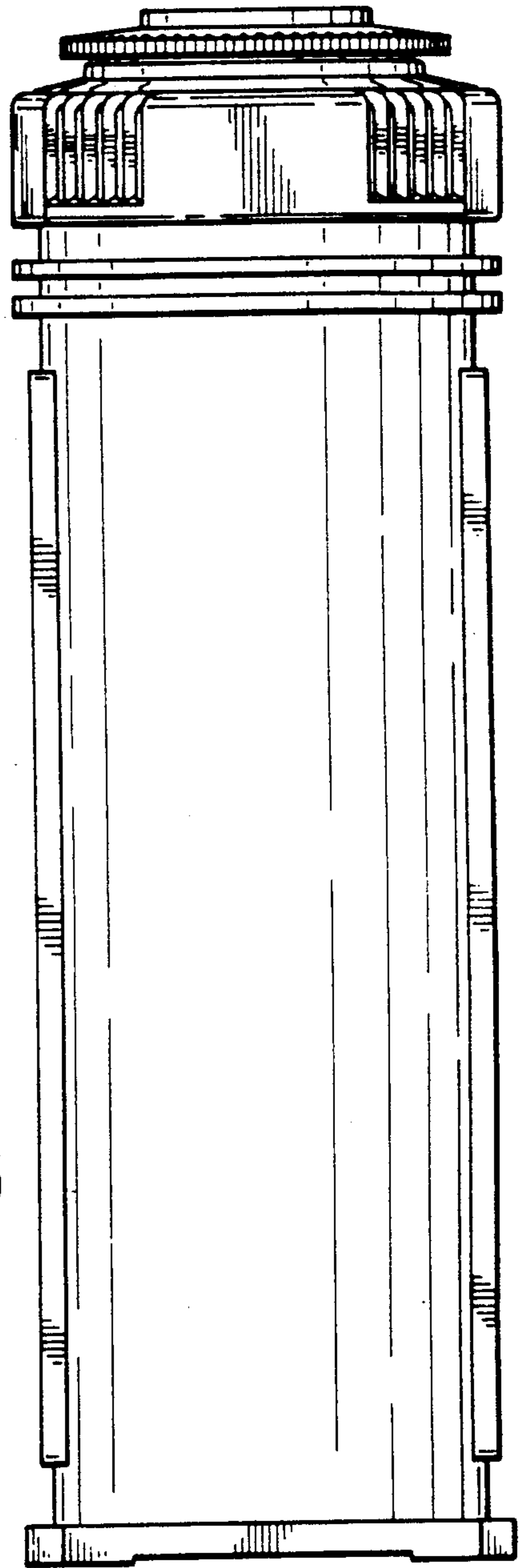

FIG. 6

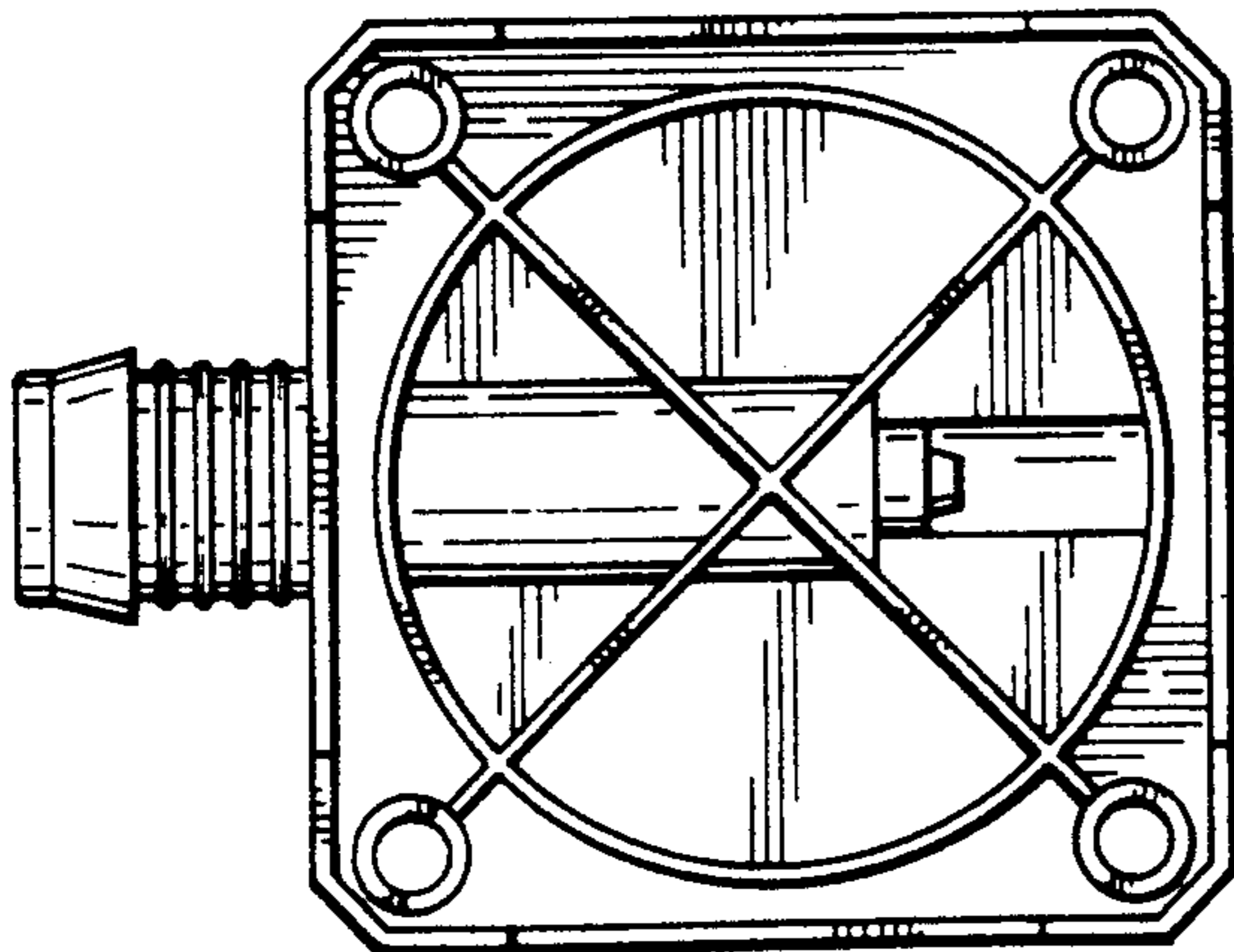

FIG. 7

FIG. 8

