

[54] AUTOMATIC DEVELOPER EXCHANGING DEVICE FOR A PHOTOCOPIER

[75] Inventors: Minoru Aoyama, Tokyo; Takeshi Komada, Yokohama, Japan

[73] Assignee: Canon Kabushiki Kaisha, Tokyo, Japan

[**] Term: 14 Years

[21] Appl. No.: 259,621

[22] Filed: Oct. 19, 1988

[30] Foreign Application Priority Data

Apr. 20, 1988 [JP] Japan 63-15972

[52] U.S. Cl. D18/40

[58] Field of Search D18/36-40, D18/42; 355/326-328

[56] References Cited

U.S. PATENT DOCUMENTS

- D. 221,694 8/1971 Gilson et al. D18/38
- D. 225,572 12/1972 Knodt et al. D18/42
- D. 227,034 5/1973 Derby et al. D18/42
- D. 281,699 12/1985 Fukuda D18/42
- D. 289,904 5/1987 Hofland D18/39 X
- D. 295,531 5/1988 Akiyama D18/42

FOREIGN PATENT DOCUMENTS

- 0220181 9/1988 Japan 355/326
- 0220266 9/1988 Japan 355/326

Primary Examiner—Nelson C. Holtje
Assistant Examiner—Caron D. Veynar
Attorney, Agent, or Firm—Fitzpatrick, Cella, Harper & Scinto

[57] CLAIM

The ornamental design for an automatic developer exchanging device for a photocopier, as shown and described.

DESCRIPTION

FIG. 1 is a front elevational view of an automatic exchanging device for developer for photo-copier showing our new design;
FIG. 2 is a rear elevational view thereof;
FIG. 3 is a top plan view thereof;
FIG. 4 is a bottom plan view thereof;
FIG. 5 is a left side elevational view thereof;
FIG. 6 is a right side elevational view thereof; and
FIG. 7 is a right, front and top perspective view thereof, the broken line showing a photocopier is environmental only and forms no part of the claimed design.

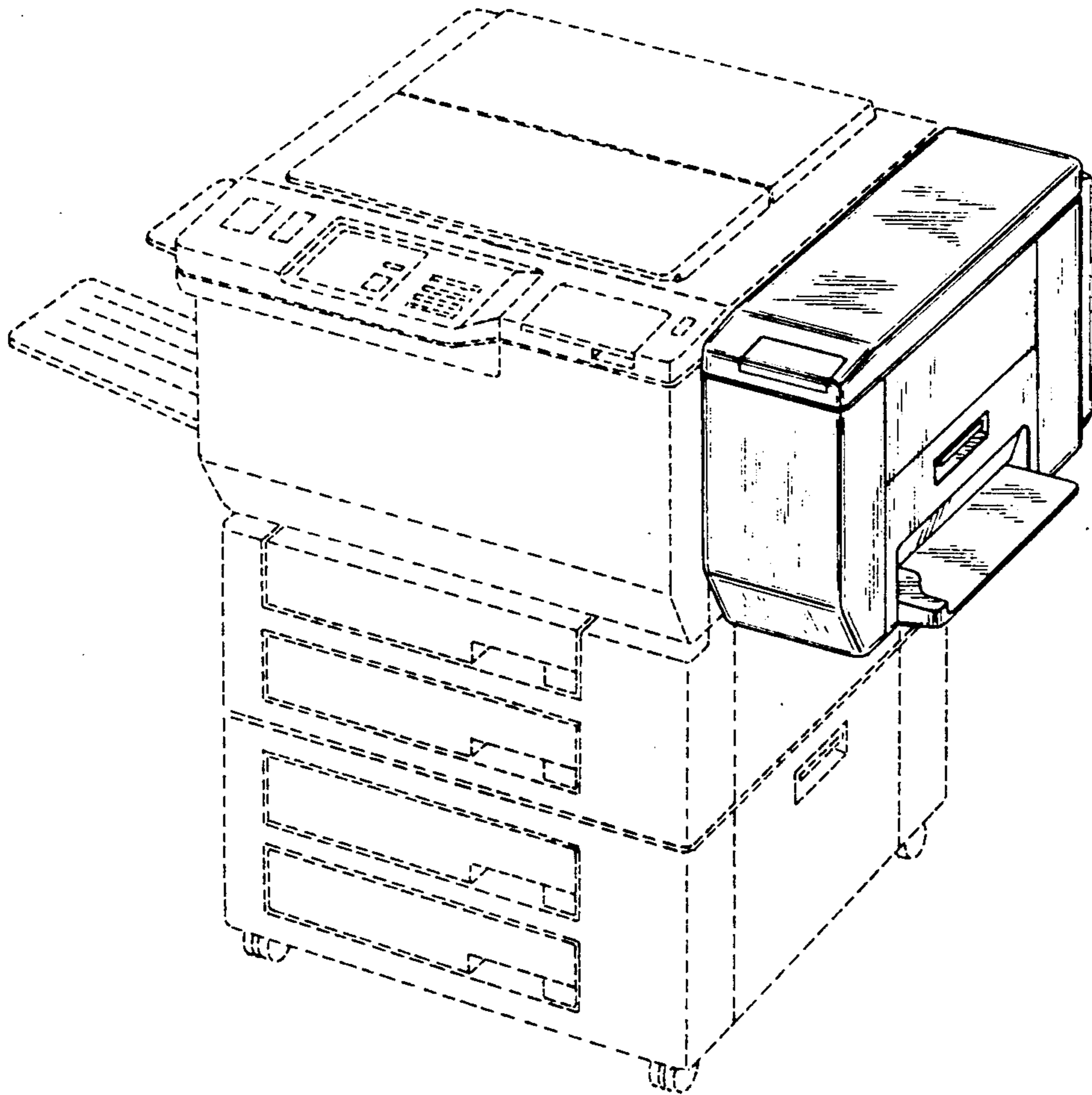

FIG. 1

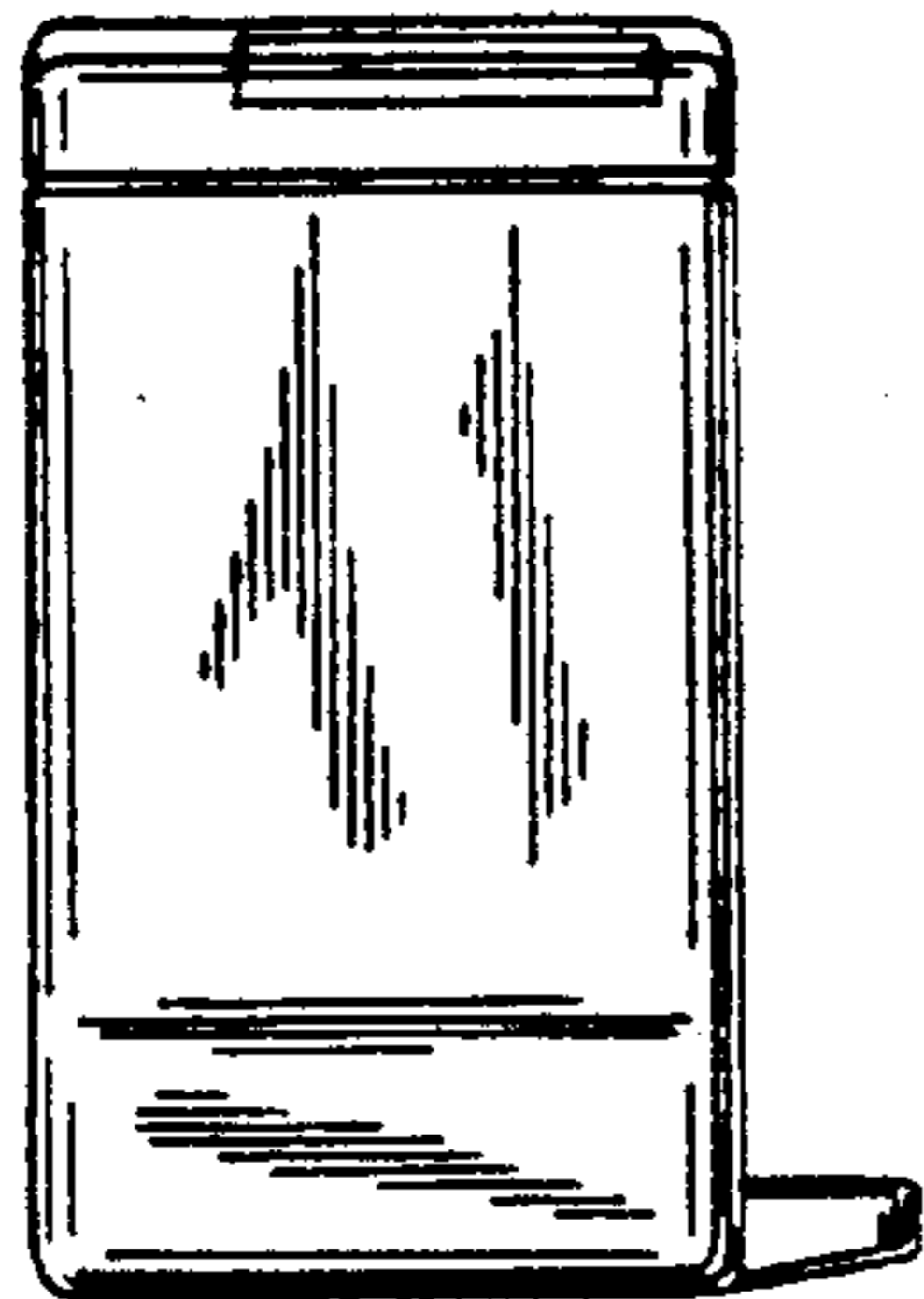

FIG. 2

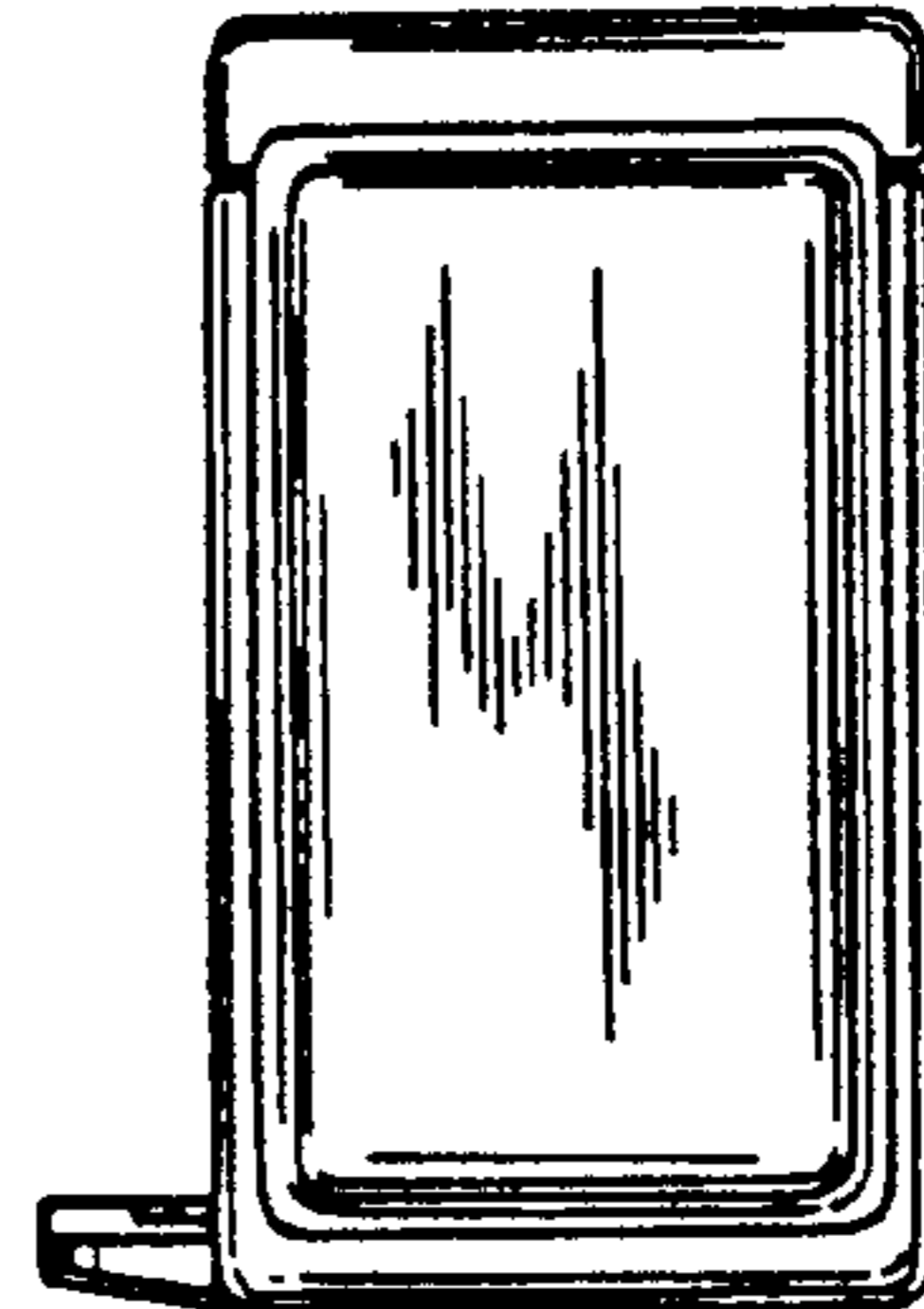

FIG. 3

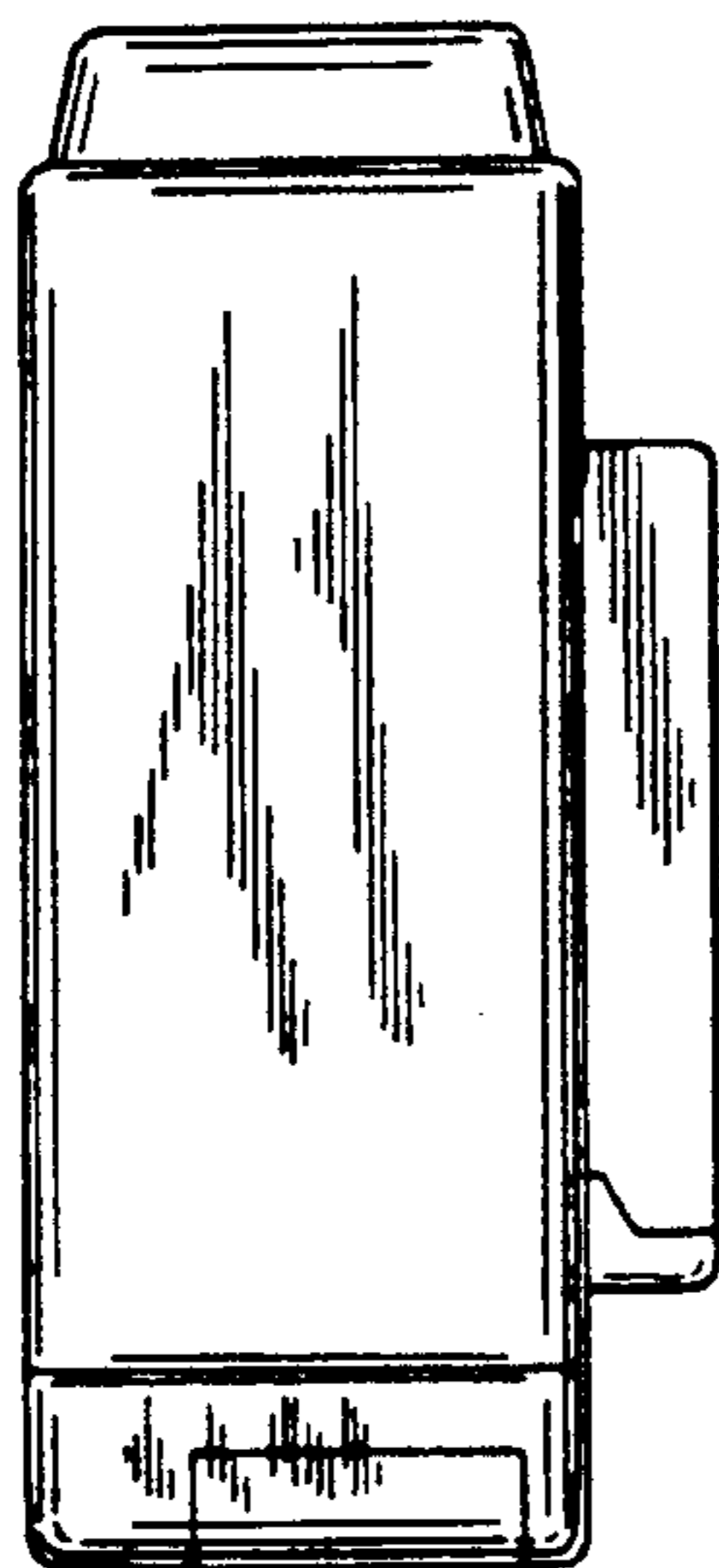

FIG. 4

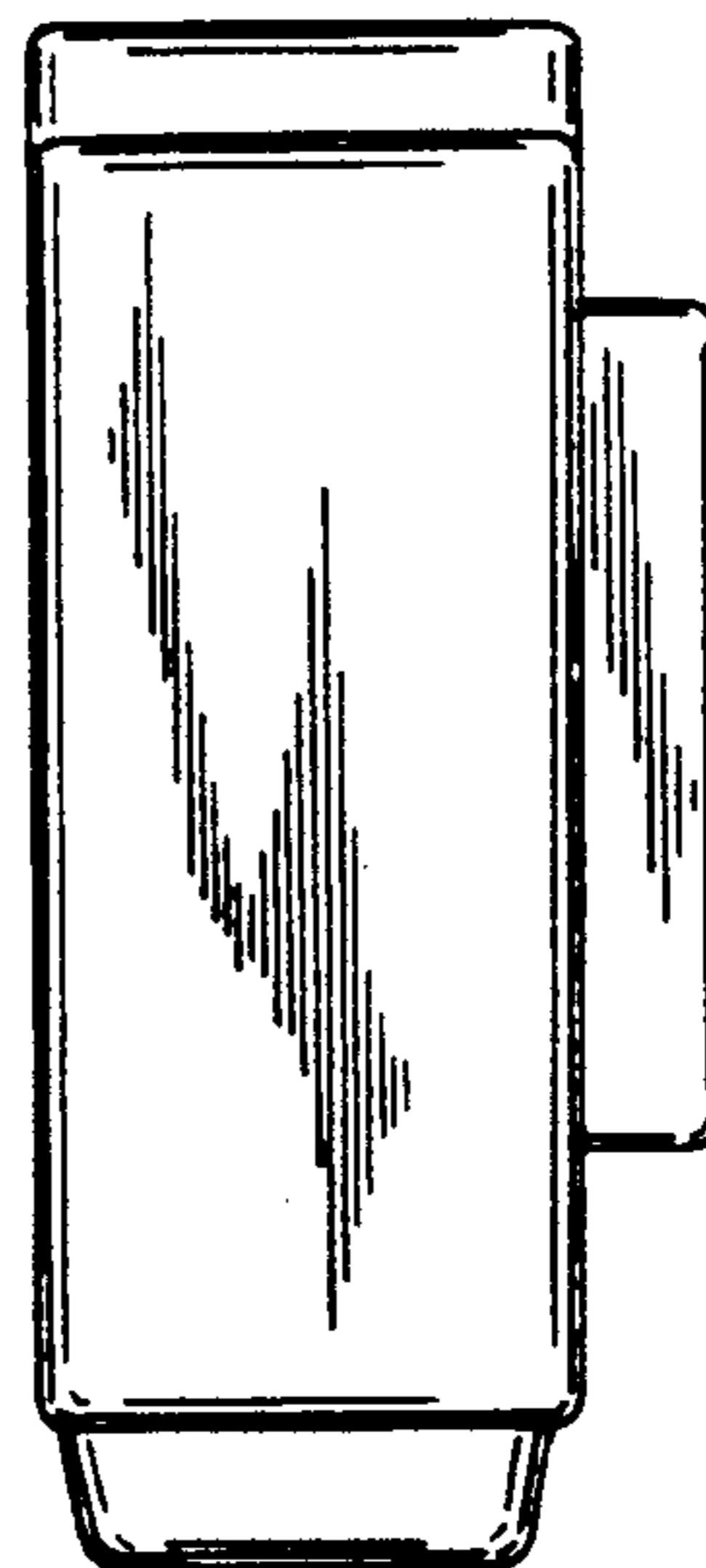

FIG. 5

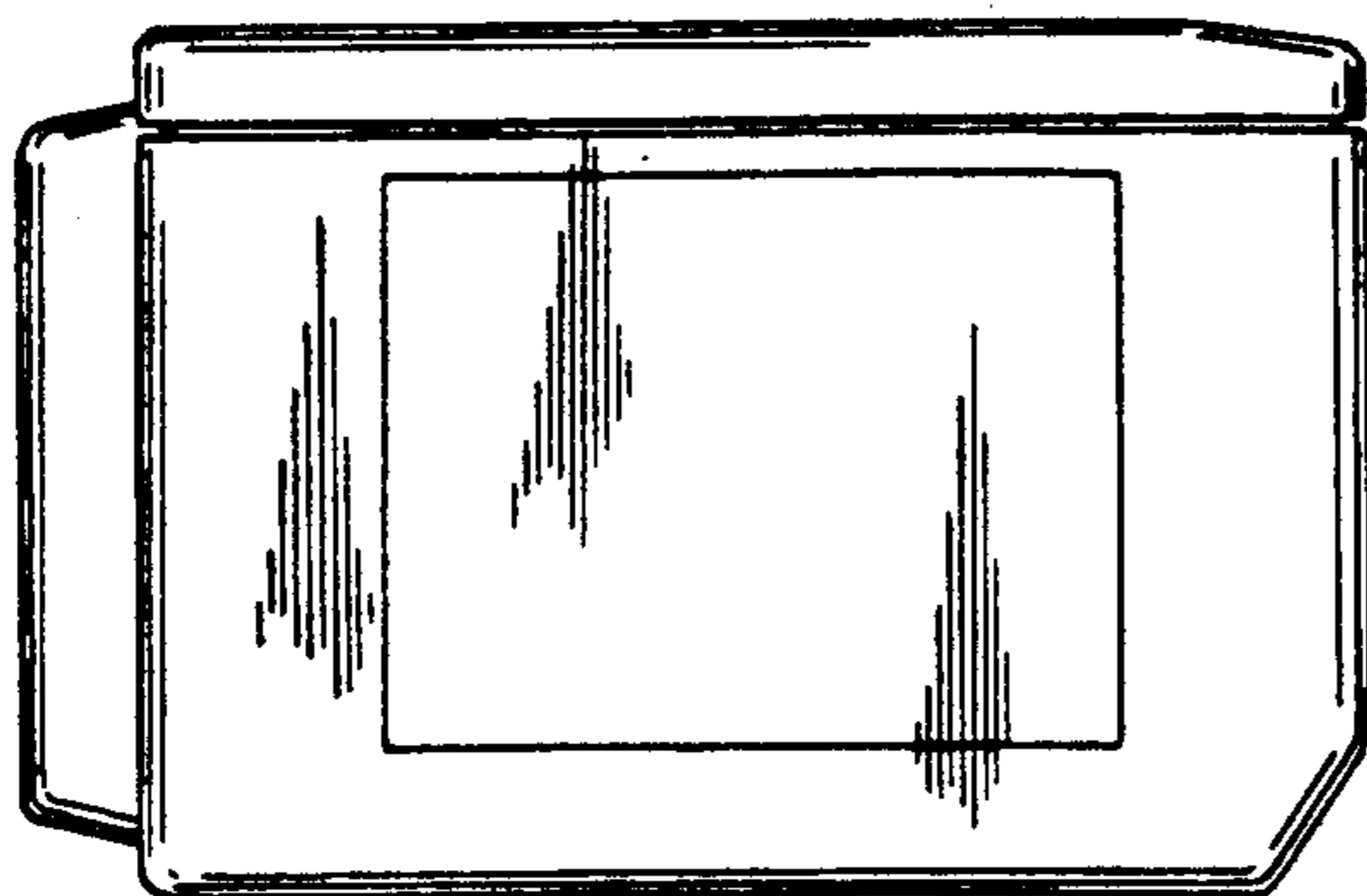

FIG. 6

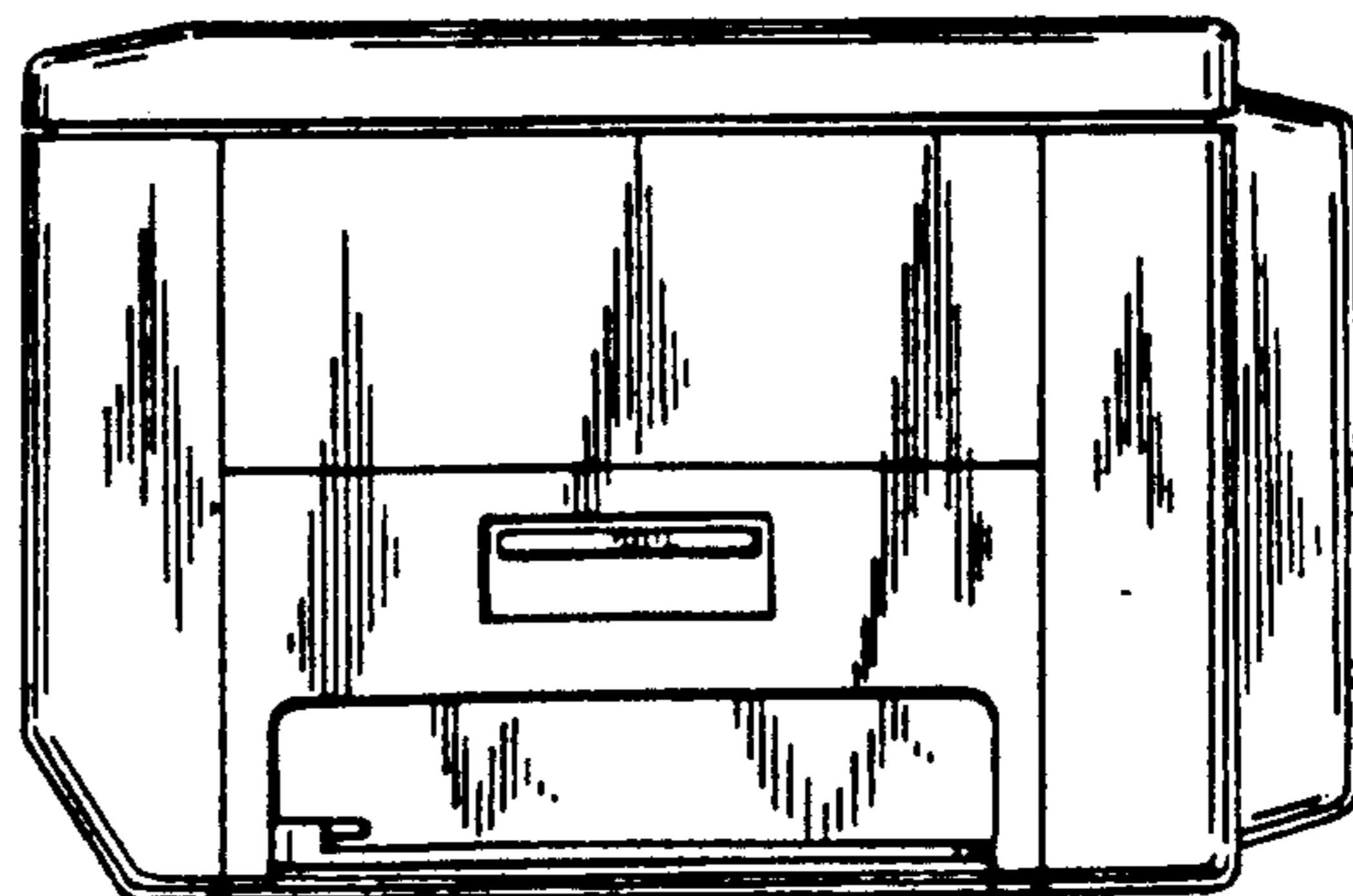

FIG. 7

