

[54] KEYBOARD

[75] Inventor: Karl D. Lerch, East Aurora, N.Y.

[73] Assignee: The Quaker Oats Company, Chicago, Ill.

[\*\*] Term: 14 Years

[21] Appl. No.: 256,286

[22] Filed: Oct. 11, 1988

[52] U.S. Cl. .... D17/1; D17/9

[58] Field of Search ..... D17/1, 2, 5, 6, 7, 9; D21/64; 84/423, 428, 644, 670, 719, 744, DIG. 7

[56] References Cited

U.S. PATENT DOCUMENTS

D. 258,899	4/1981	Hayama et al.	.....	D21/64
D. 282,850	3/1986	Futami	.....	D17/1
D. 312,266	11/1990	Shibasaki	.....	D17/1
4,619,175	10/1986	Matsuzaki	.....	84/DIG. 7

FOREIGN PATENT DOCUMENTS

2108748 5/1983 United Kingdom ..... 84/423 R

OTHER PUBLICATIONS

Best Catalog, 1984-1985, p. 326 (Casio Keyboard, Item 1).

The Music Trades, Feb. 1986, p. 29 (Bontempi X301 and X451 Keyboards).

The Music Trades, Jan. 1987, p. 101 (Casio Keyboard).

Primary Examiner—Bernard Ansher

Assistant Examiner—Adir Aronovich

Attorney, Agent, or Firm—Cumpston & Shaw

[57] CLAIM

The ornamental design for a keyboard, as shown.

DESCRIPTION

FIG. 1 is a top right front perspective view of a keyboard showing my new design;

FIG. 2 is a top plan view thereof;

FIG. 3 is a front elevational view thereof;

FIG. 4 is a bottom plan view thereof;

FIG. 5 is a rear elevational view thereof;

FIG. 6 is left side elevational view thereof; and

FIG. 7 is a right side elevational view thereof.

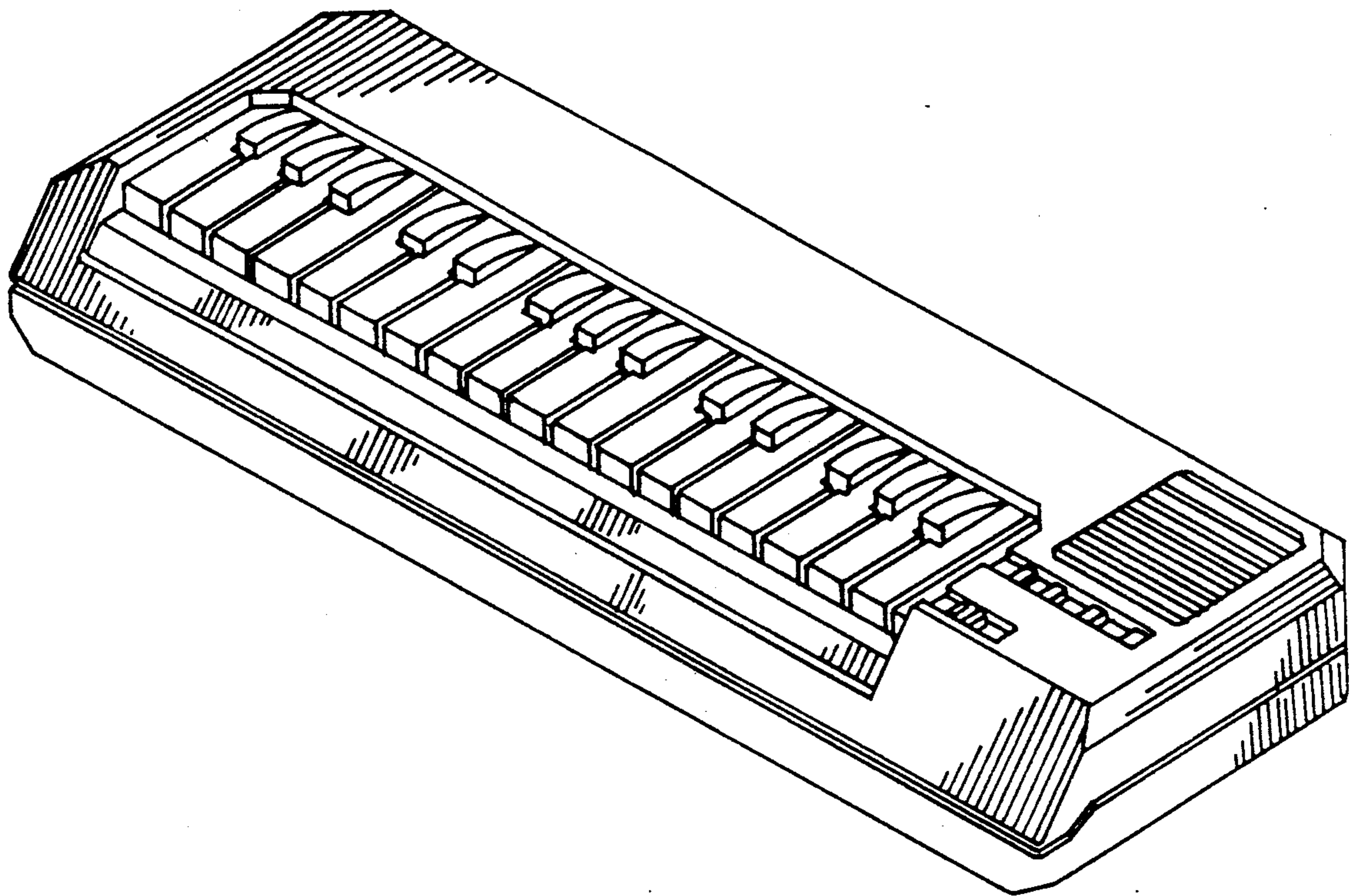

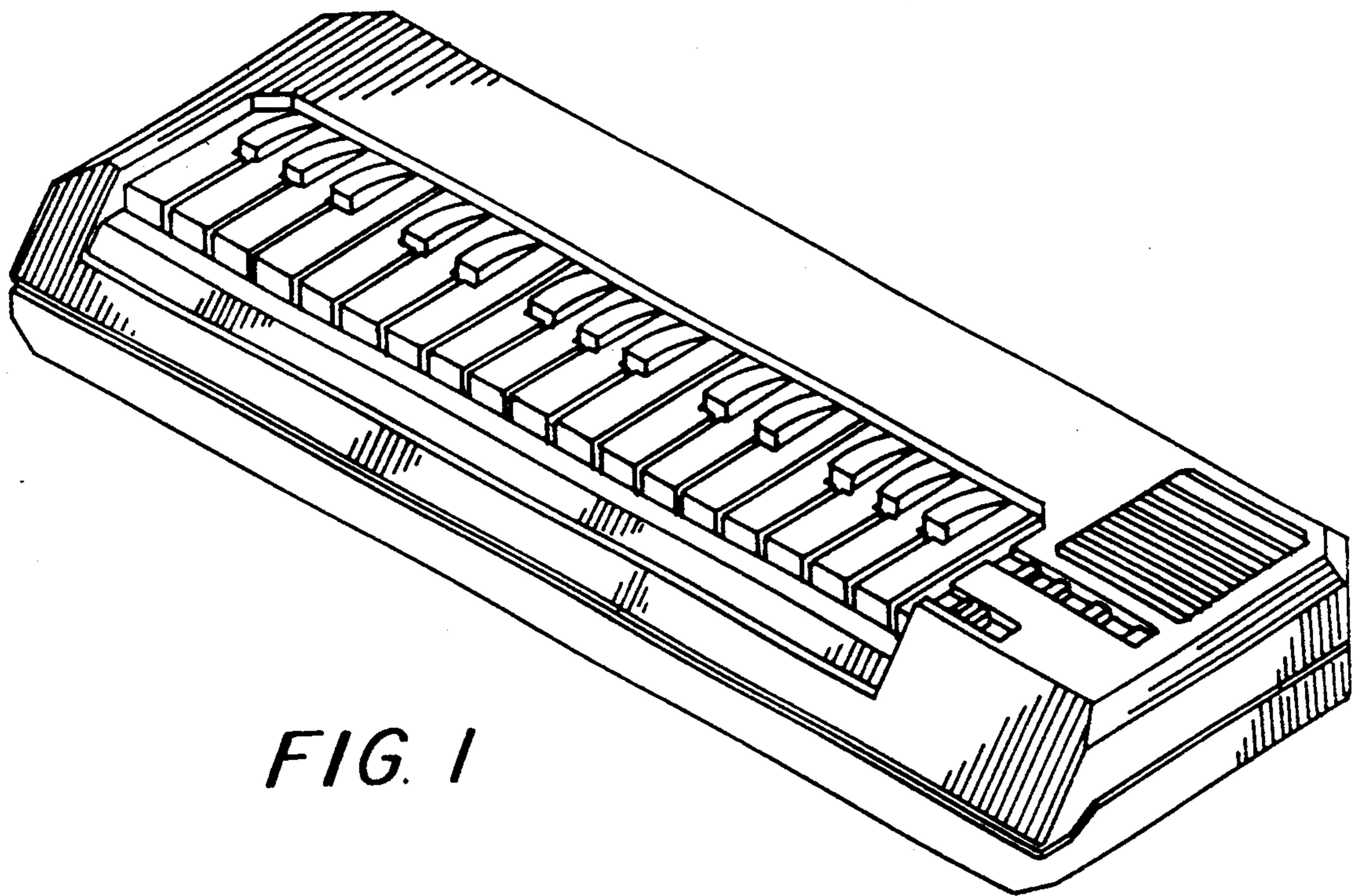

*FIG. 1*

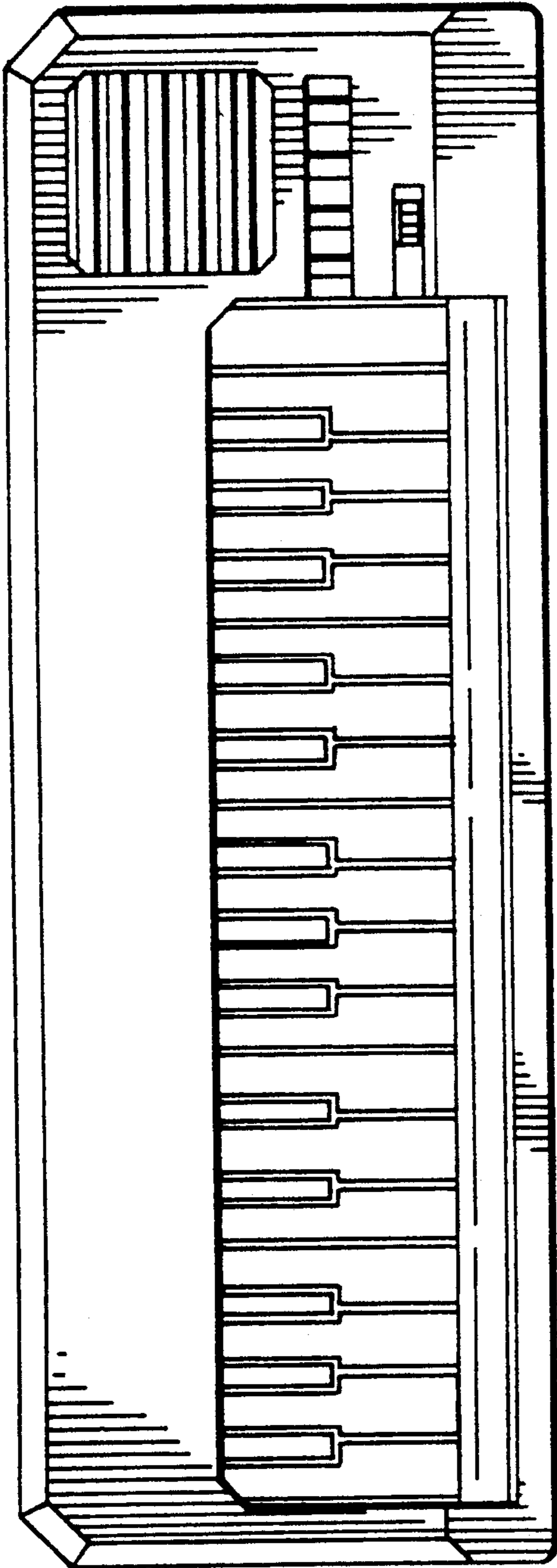

FIG. 2

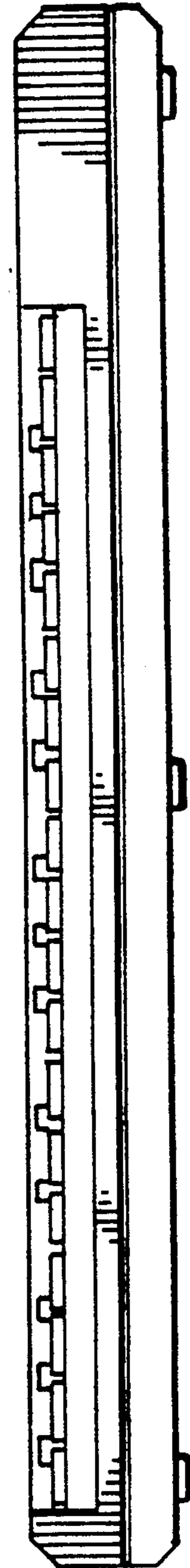

FIG. 3

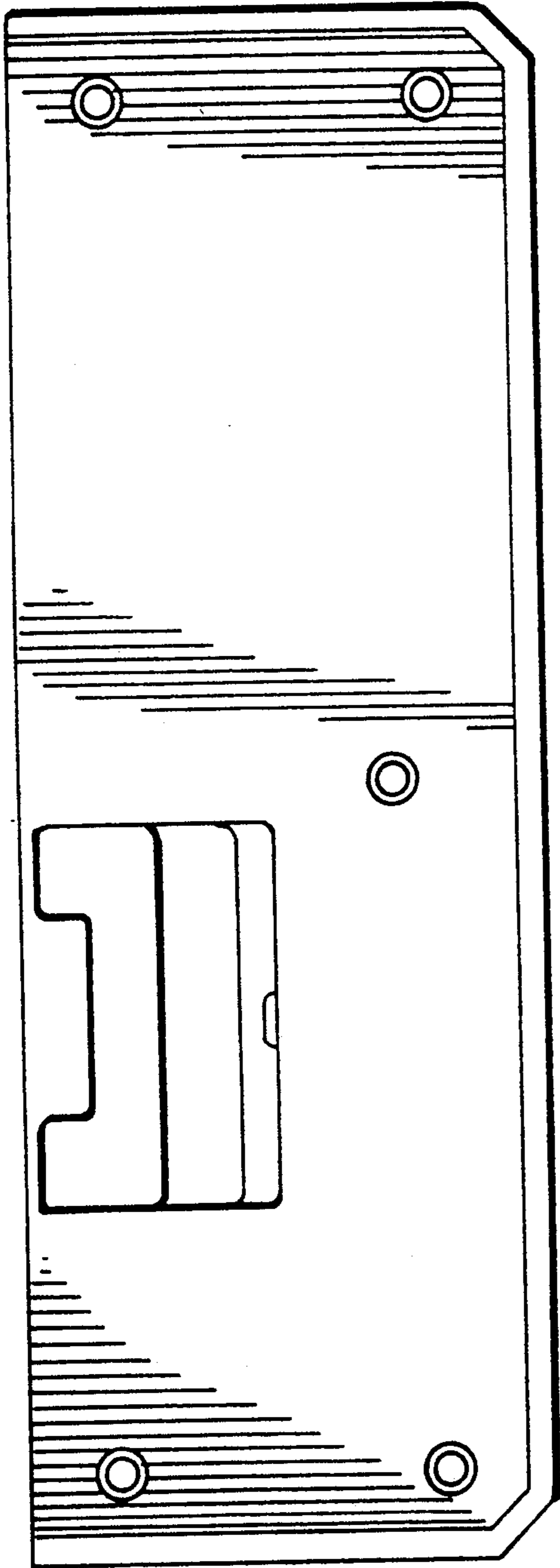

FIG. 4

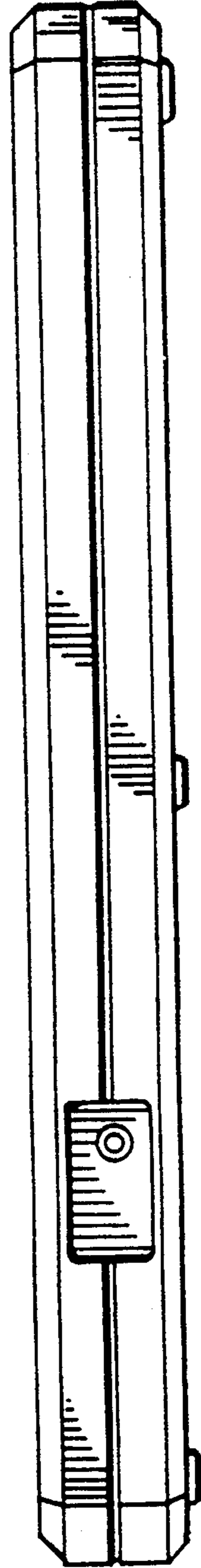
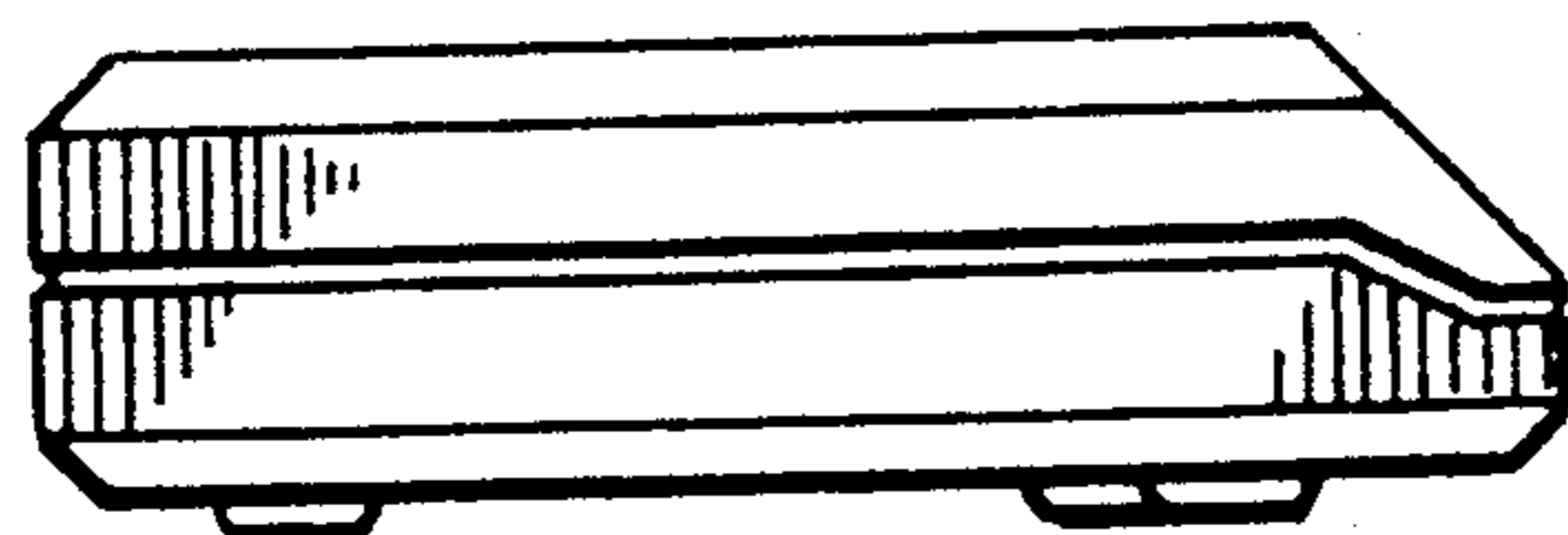
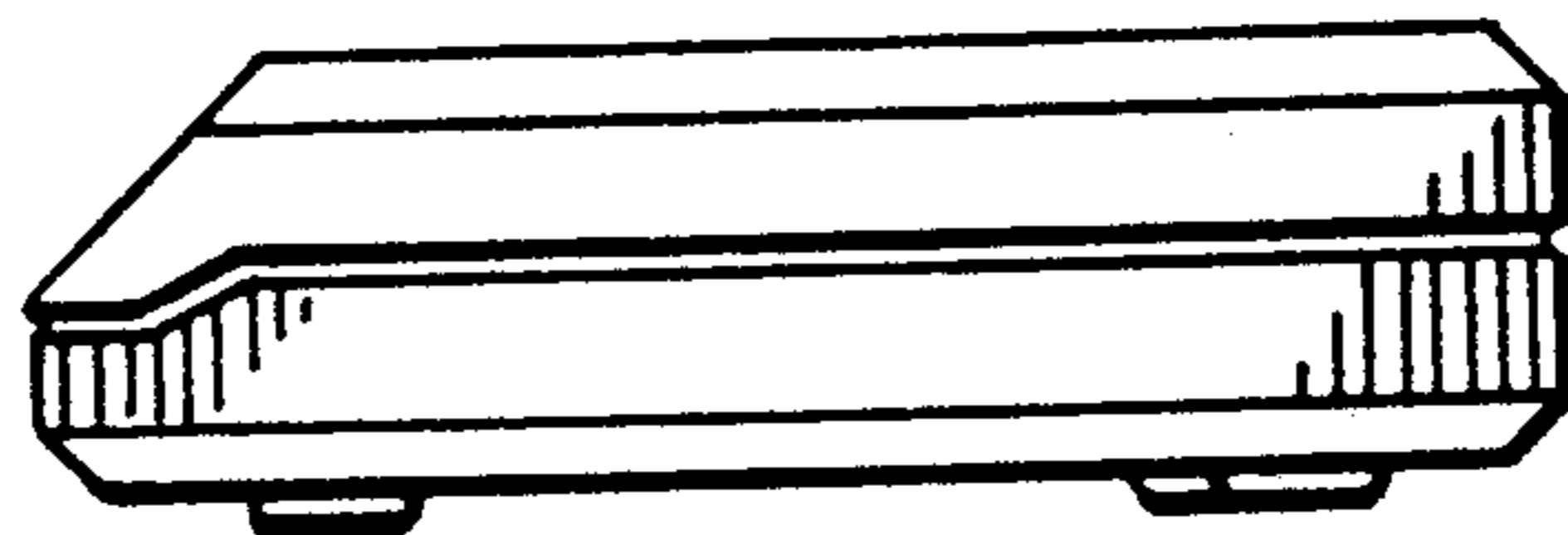

FIG. 5





*FIG. 6*



*FIG. 7*