

[54] FACSIMILE MACHINE

[75] Inventor: Akira Tsukada, Osaka, Japan

[73] Assignee: Sharp Corporation, Osaka, Japan

[**] Term: 14 Years

[21] Appl. No.: 297,065

[22] Filed: Jan. 13, 1989

[52] U.S. Cl. D14/118

[58] Field of Search D14/118, 299; D18/36, D18/37; 358/400, 401

[56] References Cited

U.S. PATENT DOCUMENTS

D. 299,494	1/1989	Tsuruoka	D14/118
D. 300,139	3/1989	Nishio	D14/118
D. 304,578	11/1989	Saegusa et al.	D14/118
D. 306,018	2/1990	Hara et al.	D14/118

OTHER PUBLICATIONS

The Office; Oct. 1988; p. 38; Nitsuko Model FX-E1.
Office Products Dealer; Nov. 1987; p. 91; Teli VaxaFax.

HFD; 12/26/88; p. 91; Panasonic Fax+ System.
Modern Office Technology; Nov. 1987; p. 11; Ricoh
Models FAX20 and FAX60.

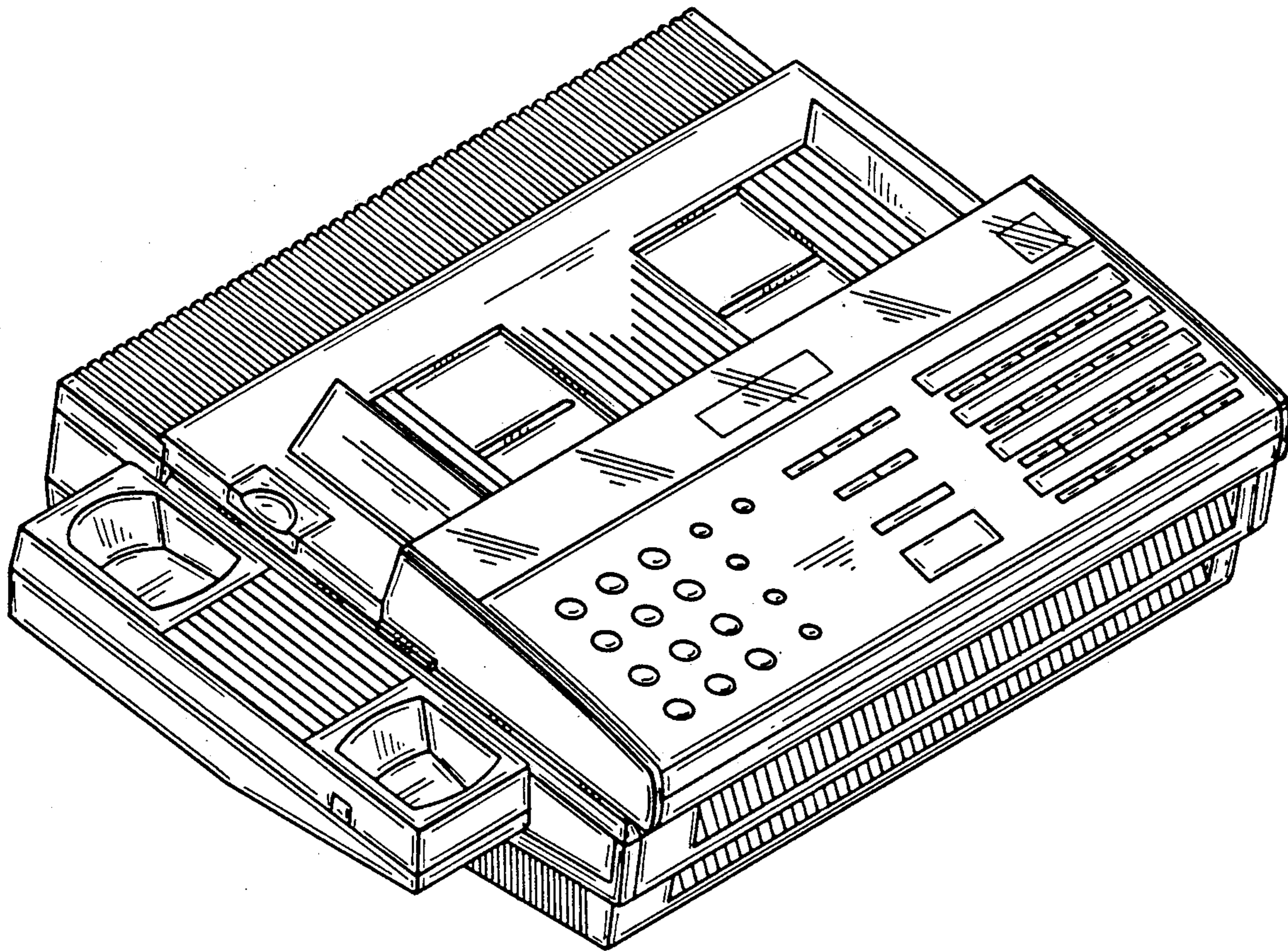
Primary Examiner—Theodore M. Shooman
Attorney, Agent, or Firm—Flehr, Hohbach, Test,
Albritton & Herbert

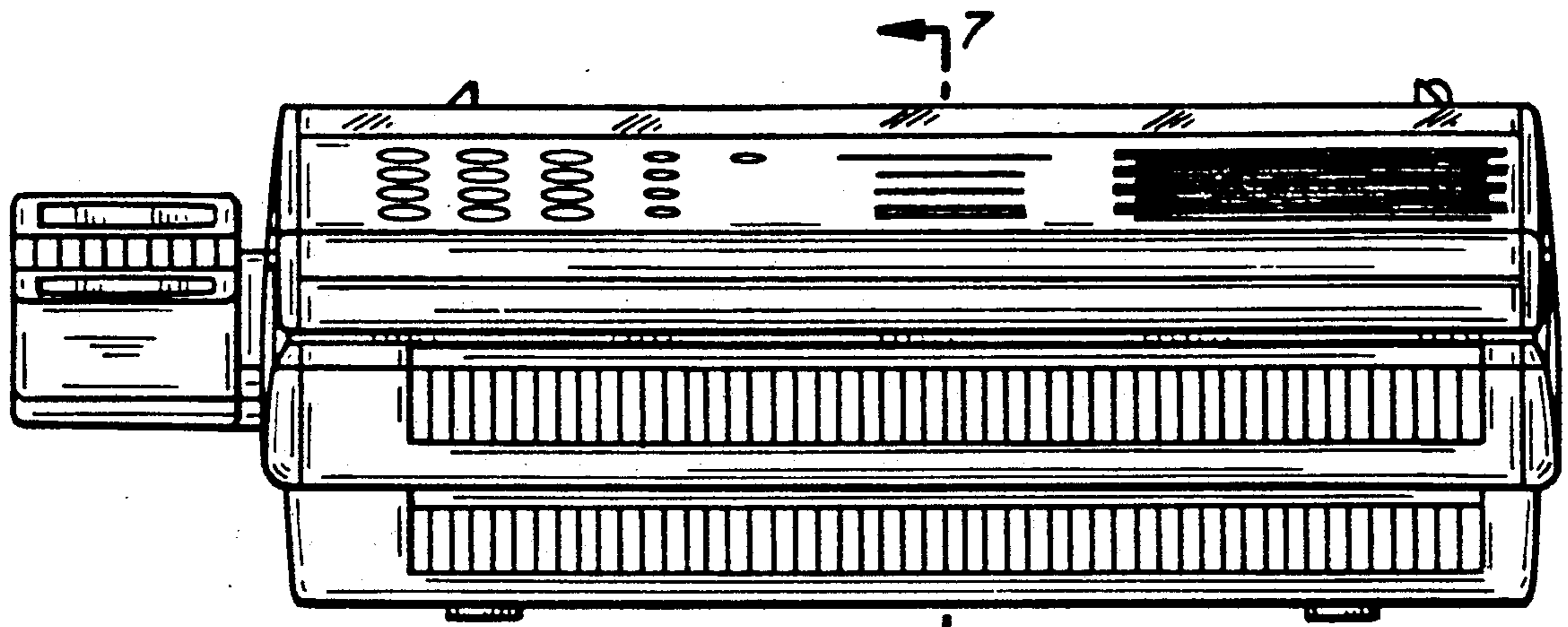
[57] CLAIM

The ornamental design for a facsimile machine, as shown.

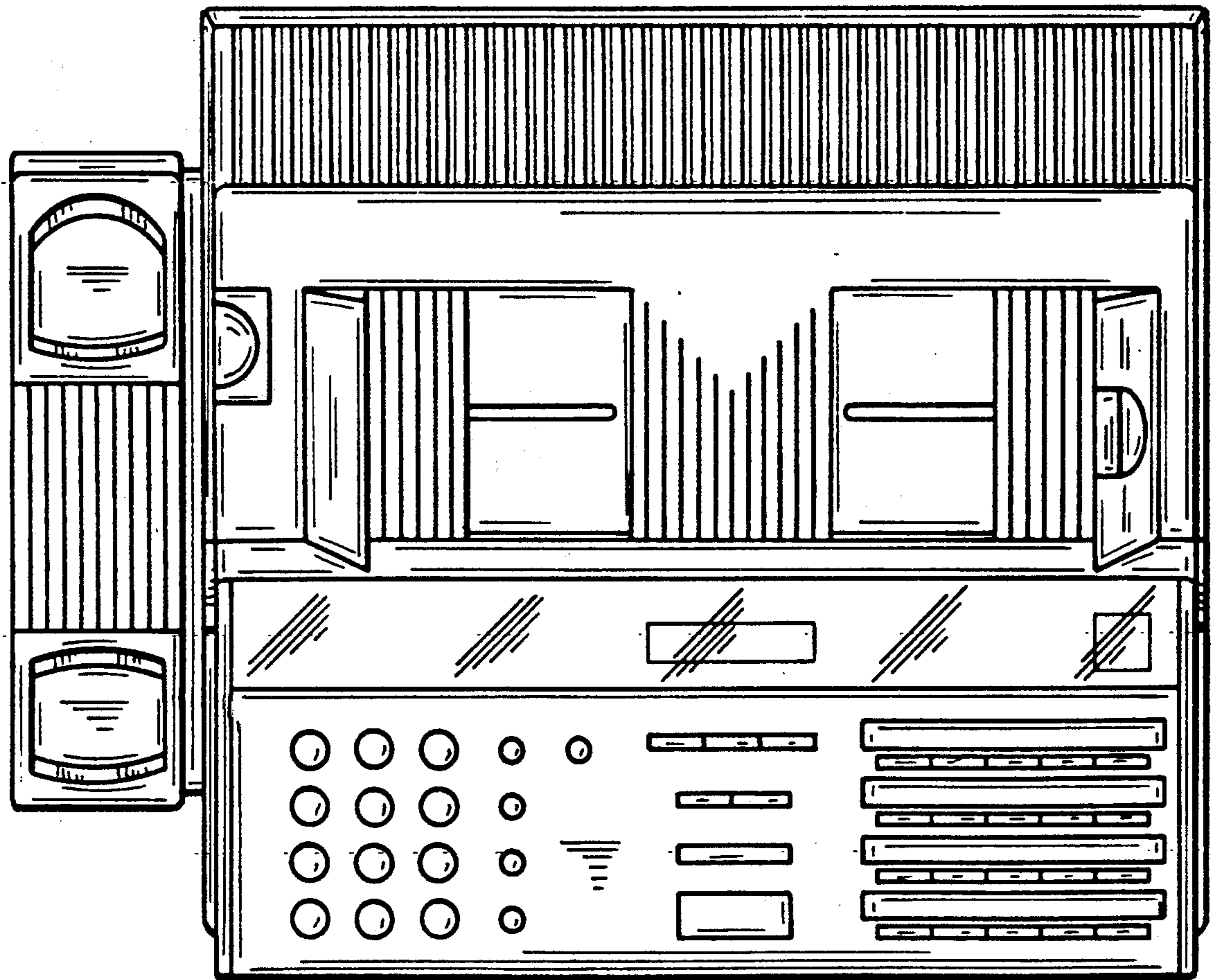
DESCRIPTION

FIG. 1 is a front elevational view of a facsimile machine showing my new design;
FIG. 2 is a top plan view thereof;
FIG. 3 is a rear elevational view thereof;
FIG. 4 is a bottom plan view thereof;
FIG. 5 is a right side elevational view thereof;
FIG. 6 is a left side elevational view thereof;
FIG. 7 is a sectional view thereof taken along the line 7—7 of FIG. 1; and
FIG. 8 is a perspective view as seen from the top, front and left side thereof.

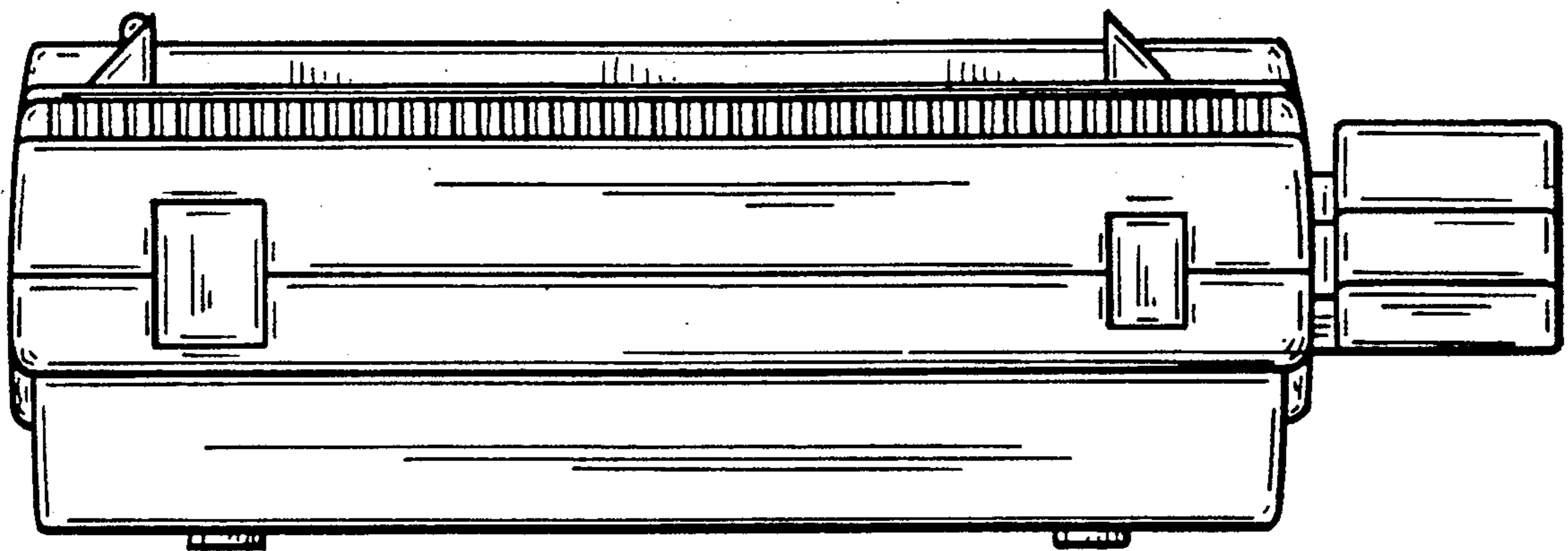




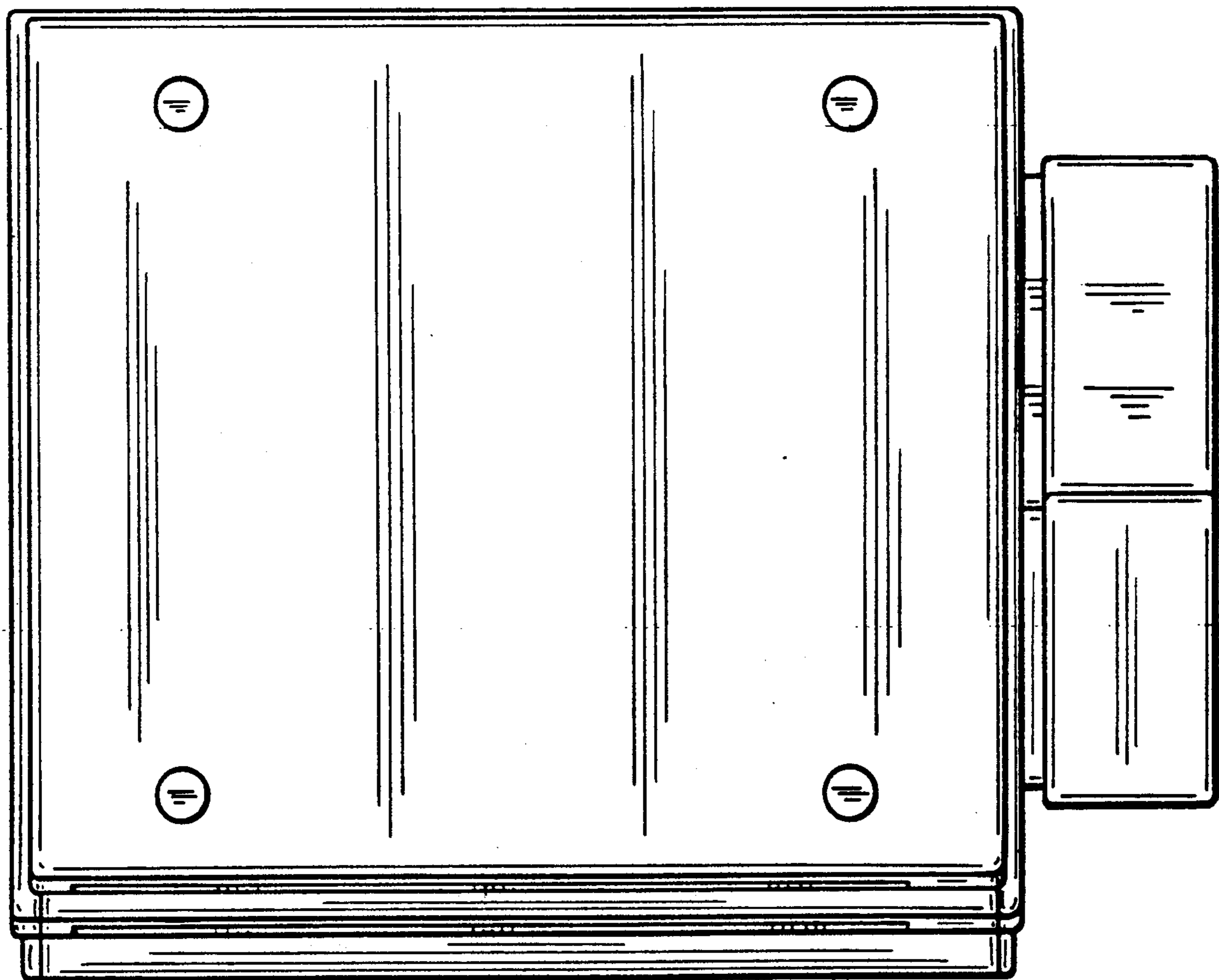
FIG_1



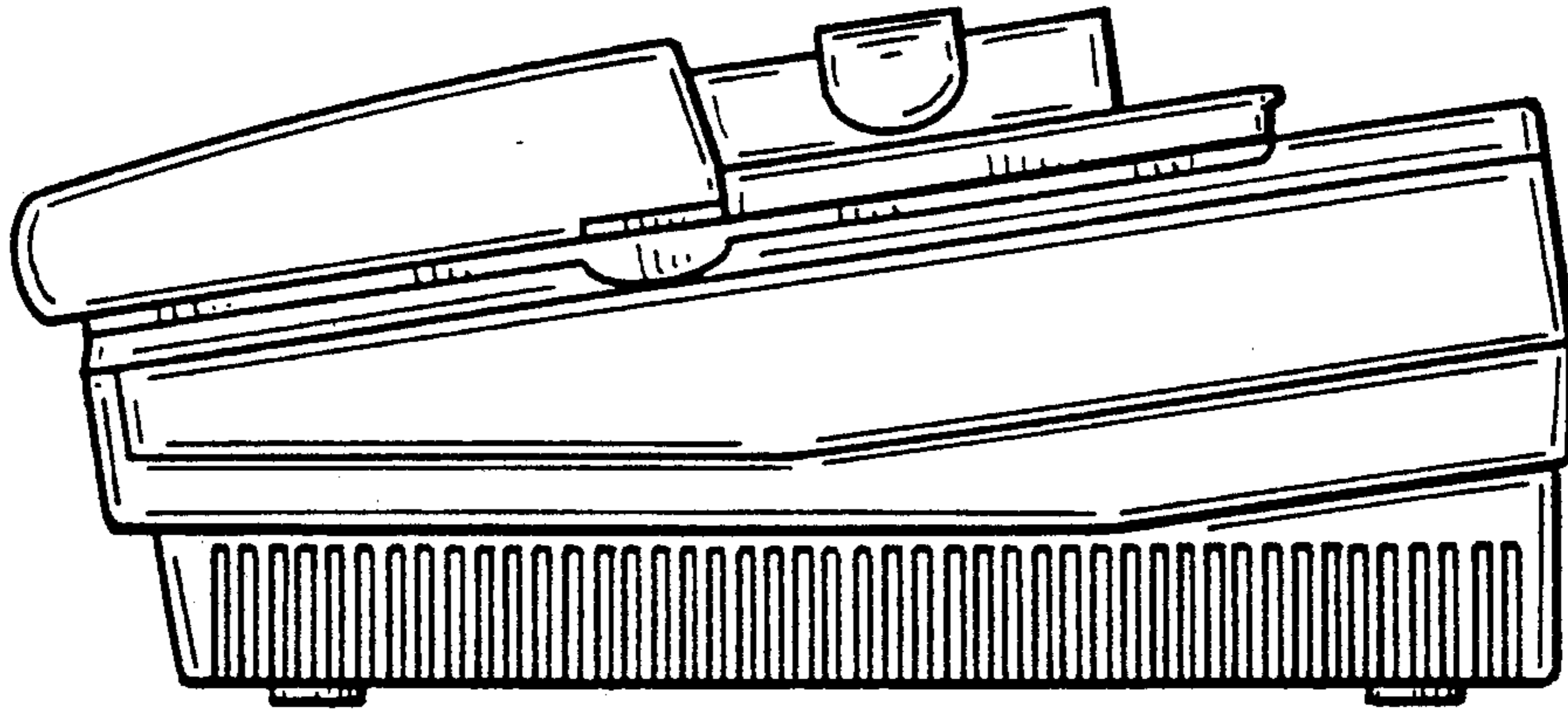
FIG_2



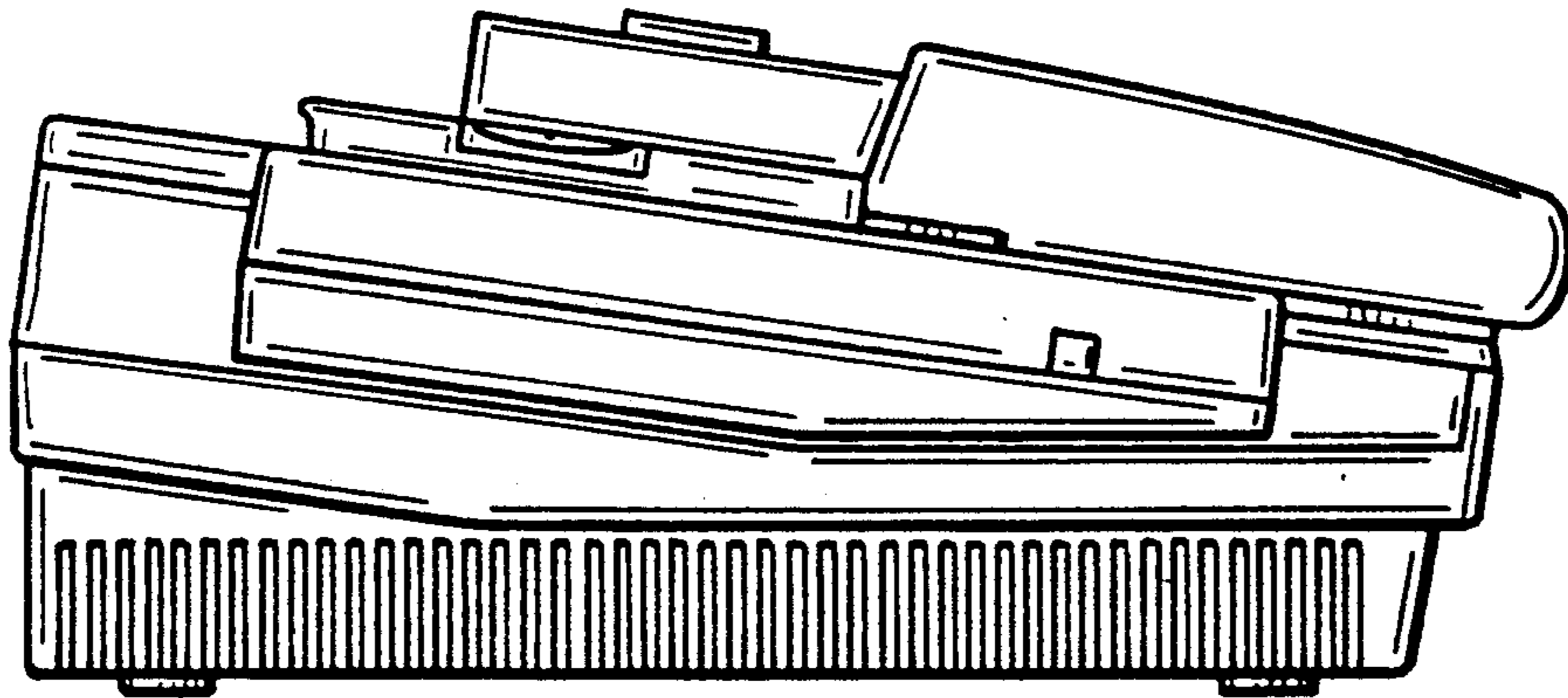
FIG_3



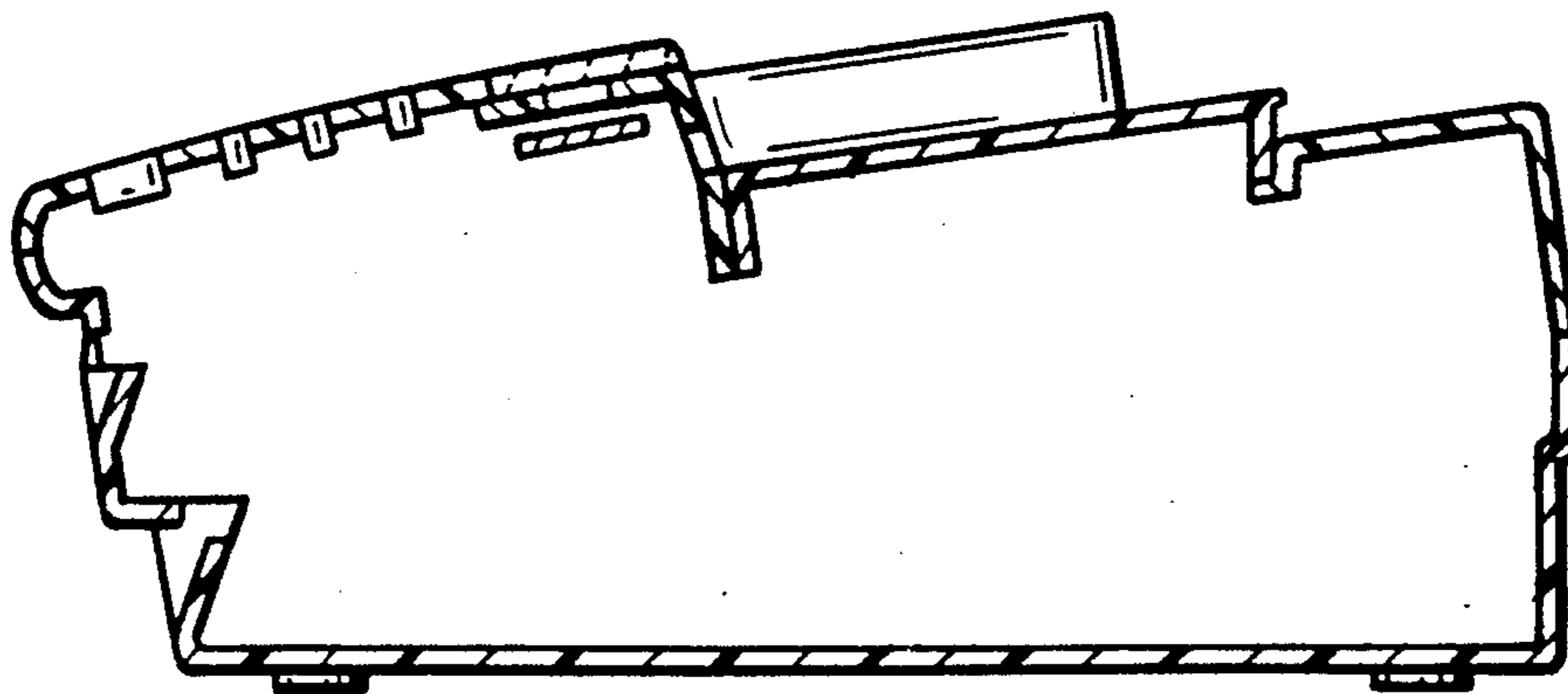
FIG_4



FIG_5



FIG_6



FIG_7

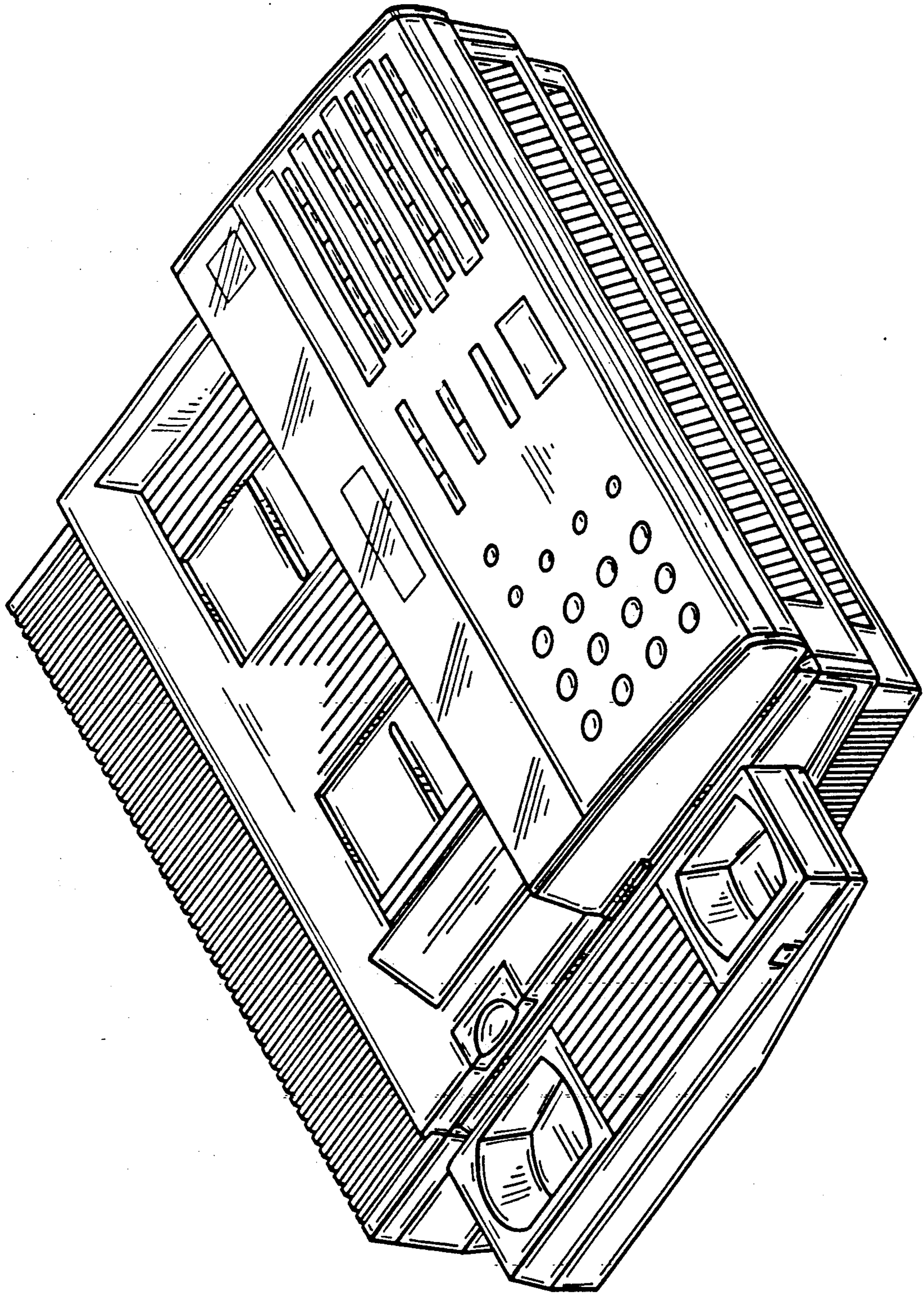


FIG-8