

[54] **NEGATIVE PRESSURE AIR FILTRATION HOUSING**

[56] **References Cited**

U.S. PATENT DOCUMENTS

4,604,111 8/1986 Natale 55/467
4,883,512 11/1989 Griffis 55/467

[75] **Inventors:** James C. Woodson; Ron W. Mumford; Kenneth S. Kondo, all of Houston, Tex.

Primary Examiner—James M. Gandy
Assistant Examiner—Lisa Lichtenstein
Attorney, Agent, or Firm—Gunn, Lee & Miller

[73] **Assignee:** Critical Industries, Inc., Houston, Tex.

[57] **CLAIM**

The ornamental design for a negative pressure air filtration housing, as shown.

[**] **Term:** 14 Years

DESCRIPTION

[21] **Appl. No.:** 408,800

FIG. 1 is a perspective view of a negative pressure air filtration housing showing our new design;
FIG. 2 is a right side elevation view thereof;
FIG. 3 is a top plan view thereof;
FIG. 4 is a left side elevation view thereof;
FIG. 5 is a bottom plan view thereof;
FIG. 6 is a front end elevation view thereof; and
FIG. 7 is a rear end elevational view thereof.

[22] **Filed:** Sep. 19, 1989

[52] **U.S. Cl. D23/365**

[58] **Field of Search D23/364, 365, 366, 355; 55/467; 422/120, 122**

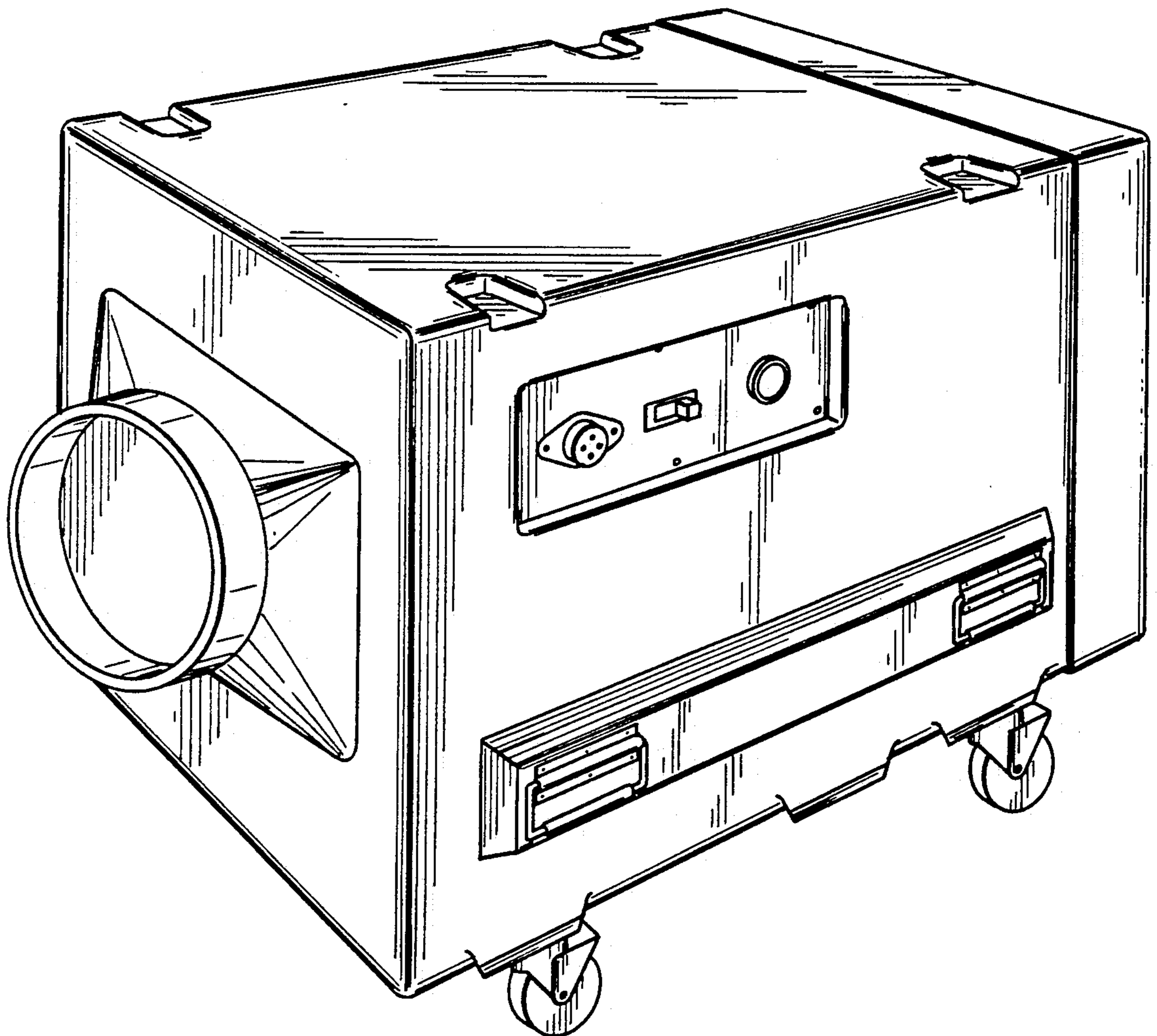

FIG. 1

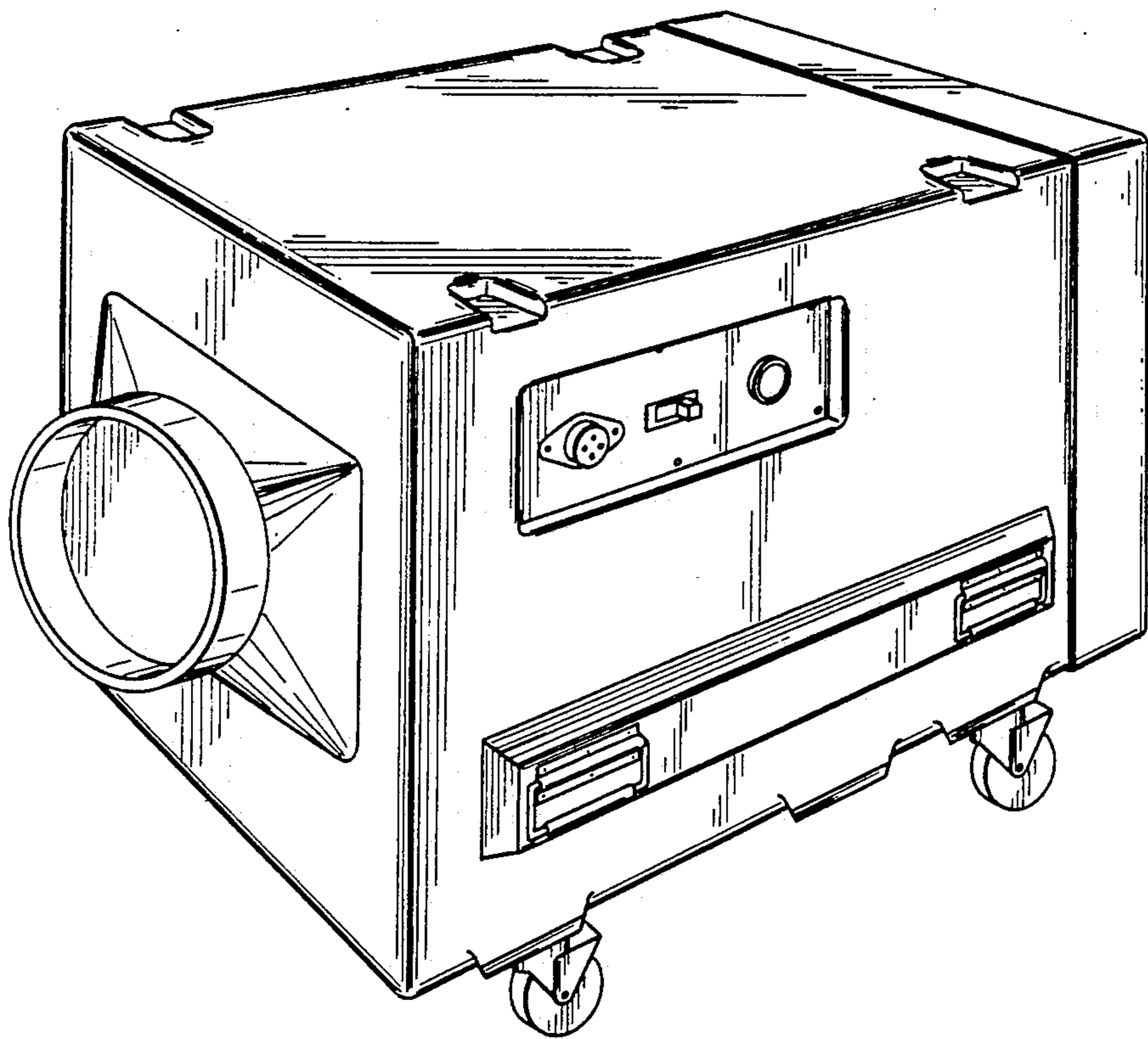

FIG. 6

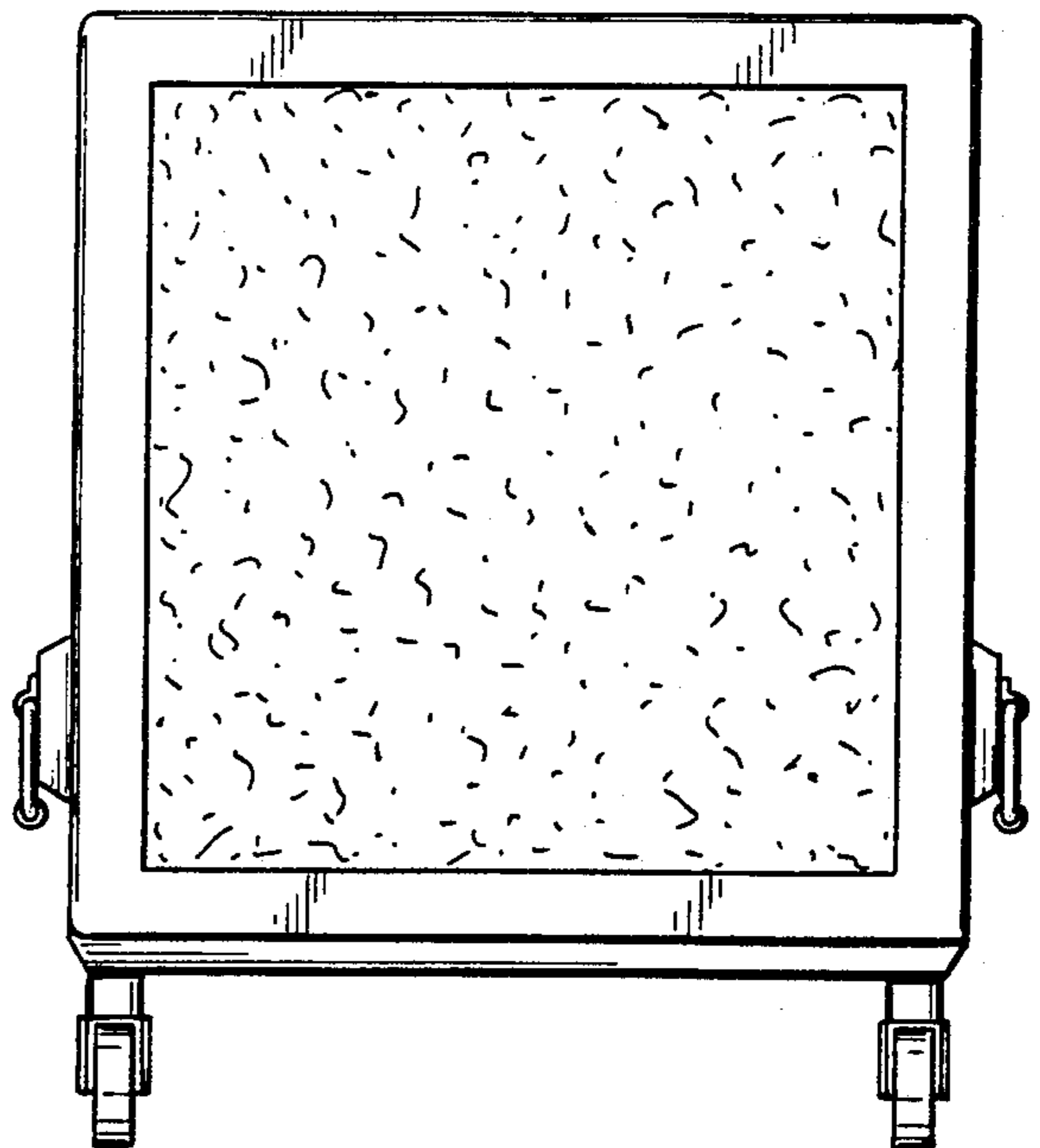
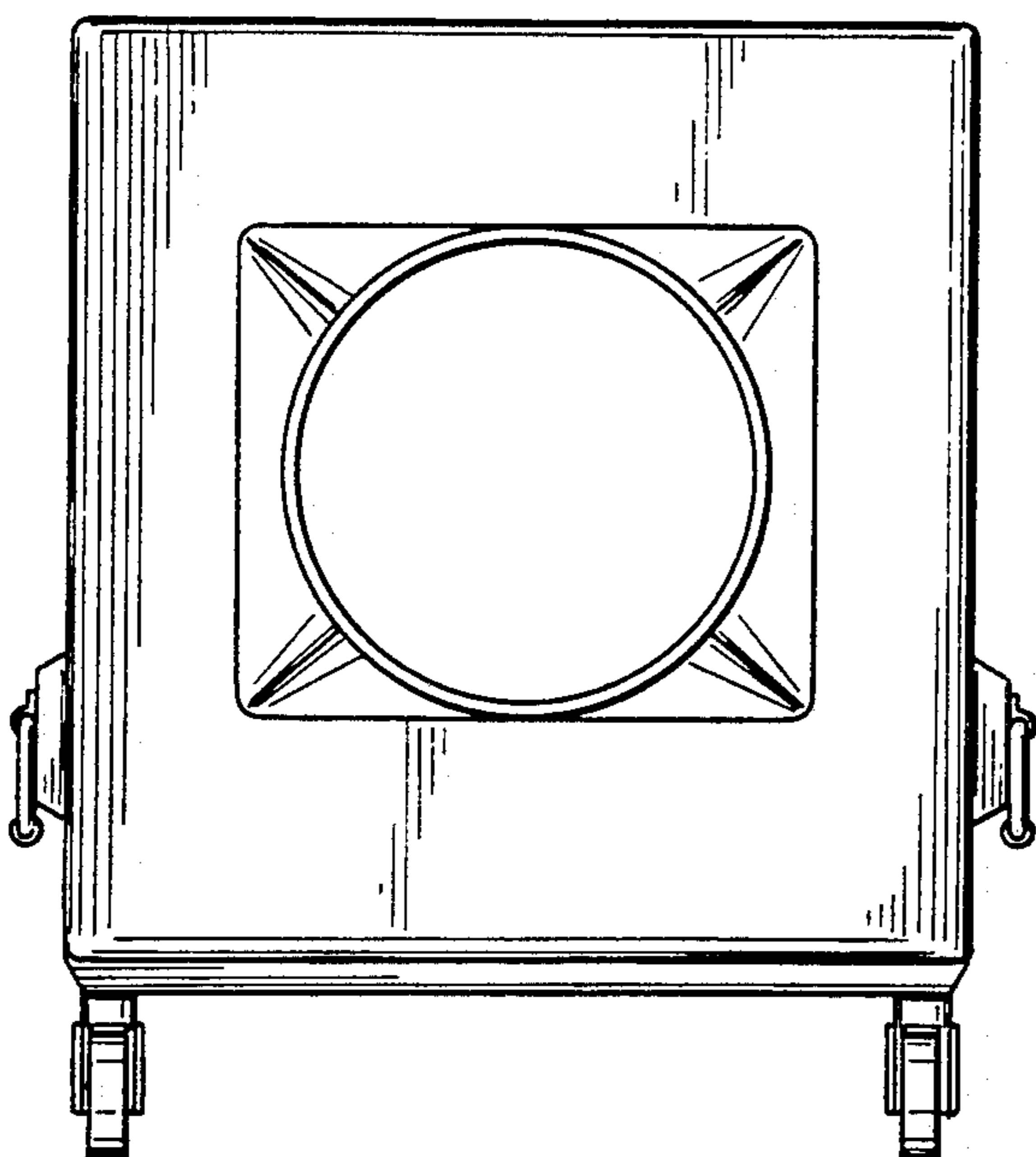

FIG. 7

FIG. 3

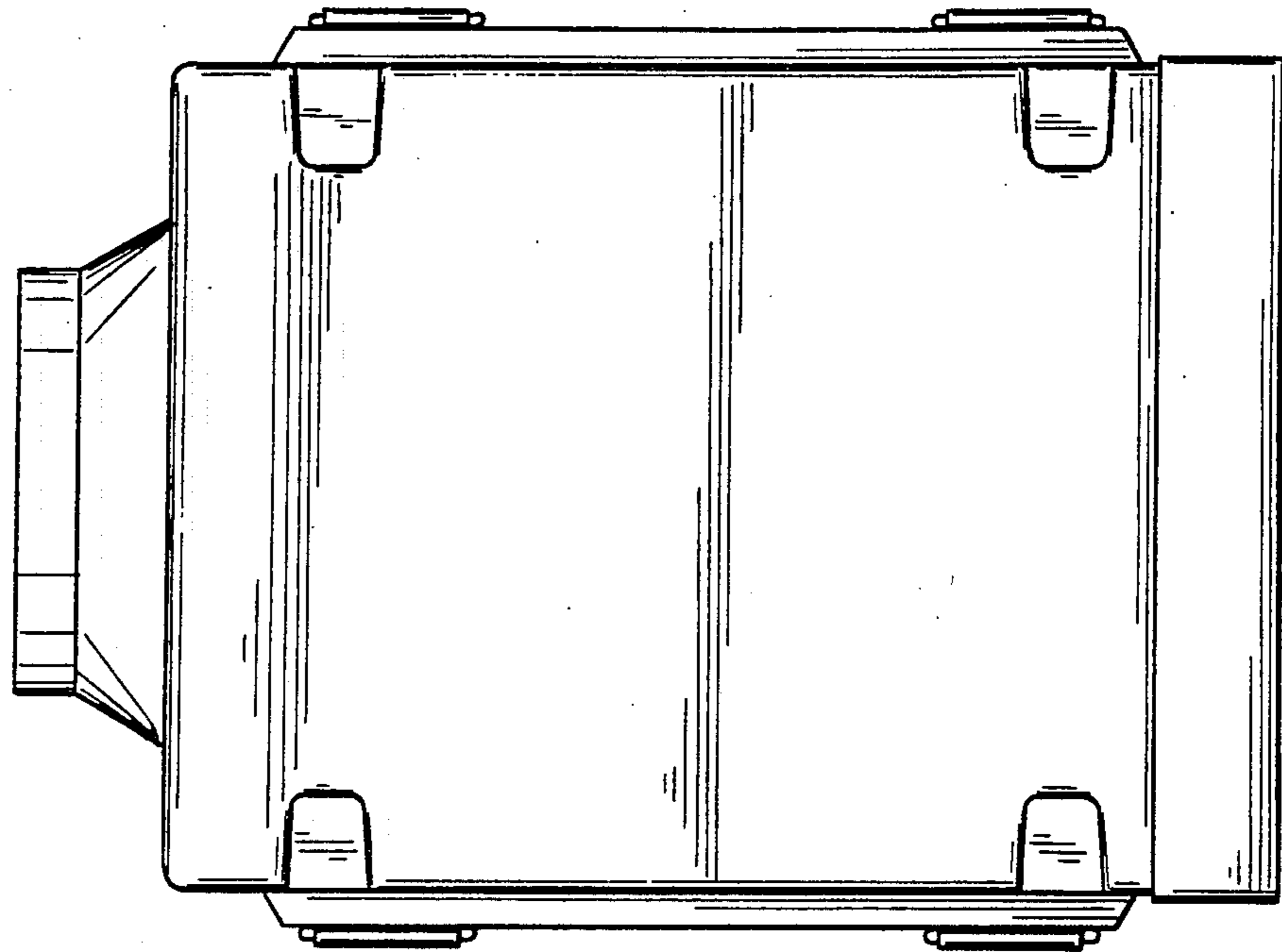

FIG. 2

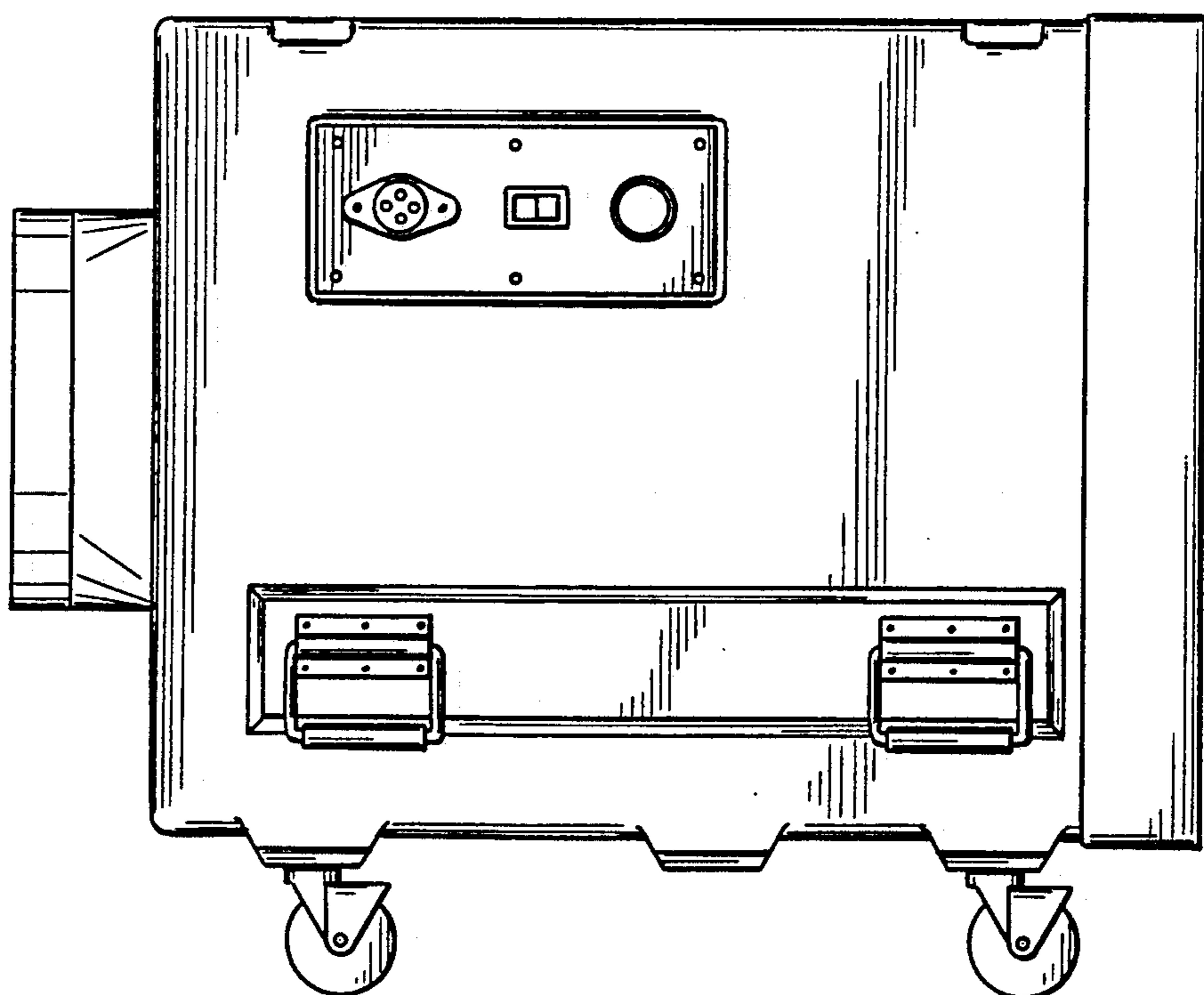

FIG. 4

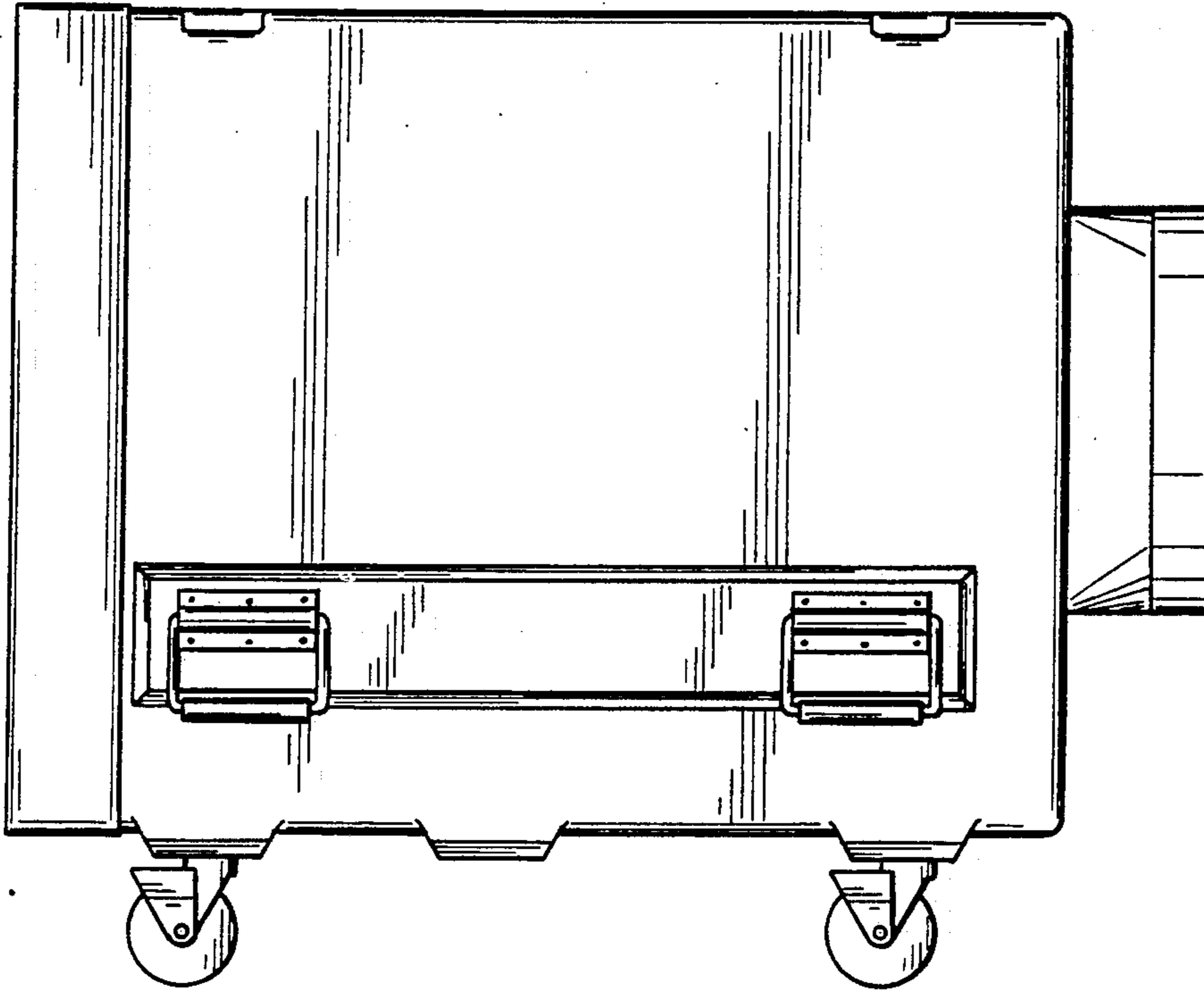

FIG. 5

