

[54] GROUND STAKE FOR RETAINING IRRIGATION CONDUIT

[76] Inventor: Donald O. Olson, 1935 Altozana Dr., El Cajon, Calif. 92020

[**] Term: 14 Years

[21] Appl. No.: 290,096

[22] Filed: Dec. 27, 1988

[52] U.S. Cl. D8/356; D23/217

[58] Field of Search D8/356, 391; D30/145-154; 172/24; 239/276; 248/80, 87, 156, 530

[56] References Cited

U.S. PATENT DOCUMENTS

D. 245,032	7/1977	Hoffmann	D30/154
D. 285,409	9/1986	Lenkin et al.	D8/356
3,473,770	10/1969	Edgerton	248/87
3,941,342	3/1976	Bradshaw	239/276
3,994,441	11/1976	Testa	239/276
4,256,262	3/1981	Rosenberg et al.	239/276
4,850,555	7/1989	Lemkin et al.	248/156 X

FOREIGN PATENT DOCUMENTS

2038974	7/1980	United Kingdom	248/87
---------	--------	----------------	-------	--------

OTHER PUBLICATIONS

Hardware Age, Aug. 1986, p. 330, Stake for Irrigation

Tubing, located at bottom of page under 'Sherman' ad, see circled item.

Hardware Age, May 1986, p. 139, Stake for Irrigation Tubing, located at top left hand corner-see circled item. Hardie Irrigation Catalog p. 2-1, Oct. 15, 1985, Stake to suit Hydrojet, item H, located at top, far right side.

Primary Examiner—Wallace R. Burke
Assistant Examiner—Holly H. Baynham
Attorney, Agent, or Firm—Owen, Wickersham & Erickson

[57] CLAIM

The ornamental design for ground stake for retaining irrigation conduit, as shown and described.

DESCRIPTION

FIG. 1 is a front perspective view of a ground stake for retaining irrigation conduit embodying my new design; FIG. 2 is a top plan view thereof; FIG. 3 is a bottom plan view thereof; FIG. 4 is a front elevational view thereof; FIG. 5 is a left side elevational view thereof; FIG. 6 is a rear elevational view thereof; FIG. 7 is a right side elevational view thereof; The broken line showing of a hose is for illustrative purposes only and forms no part of the claimed design.

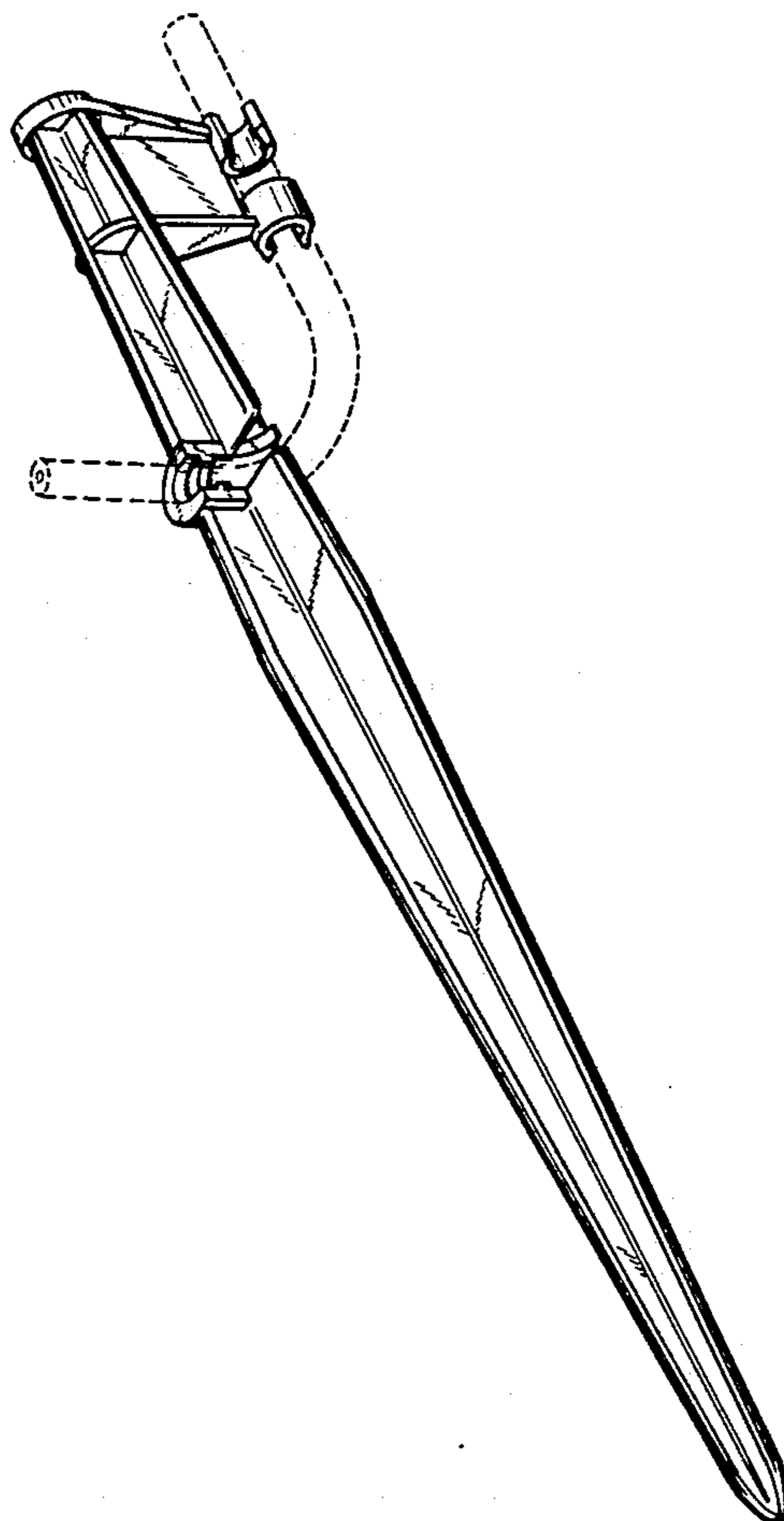

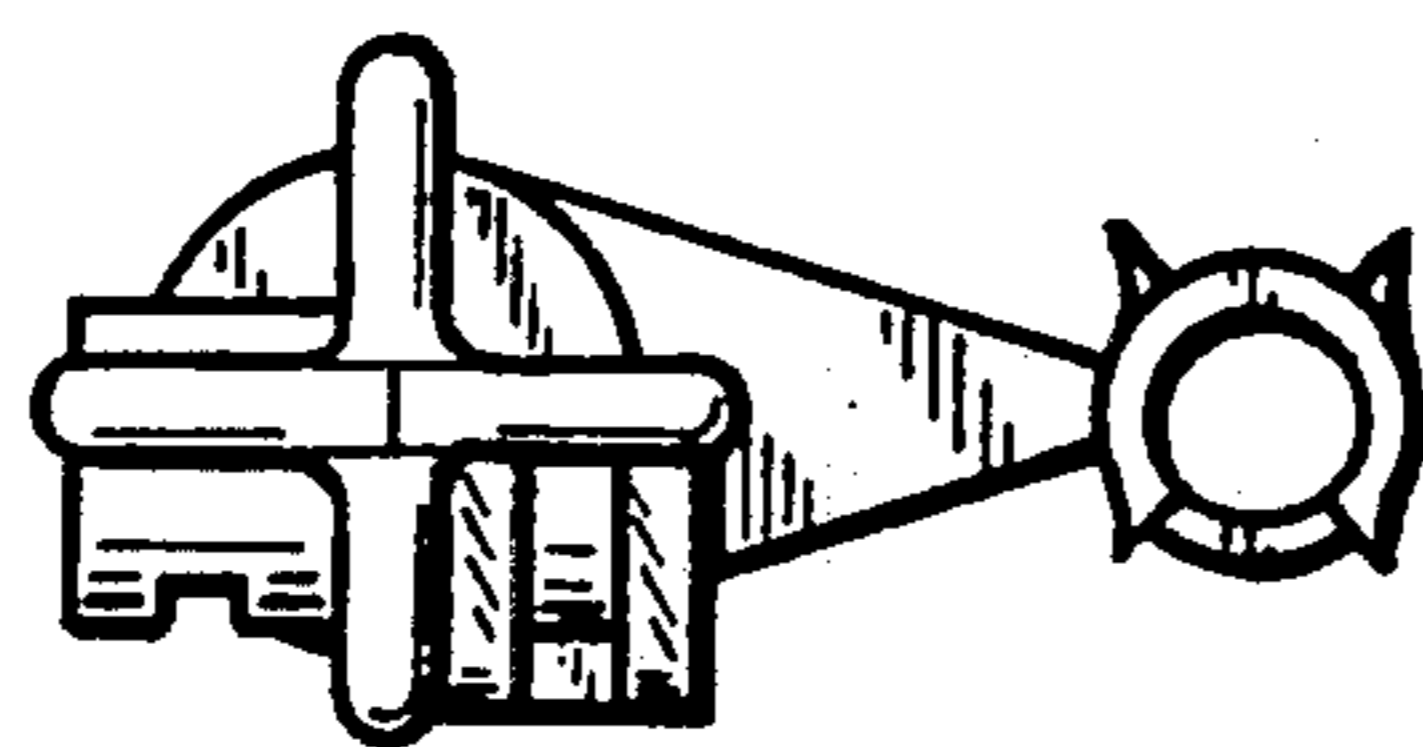
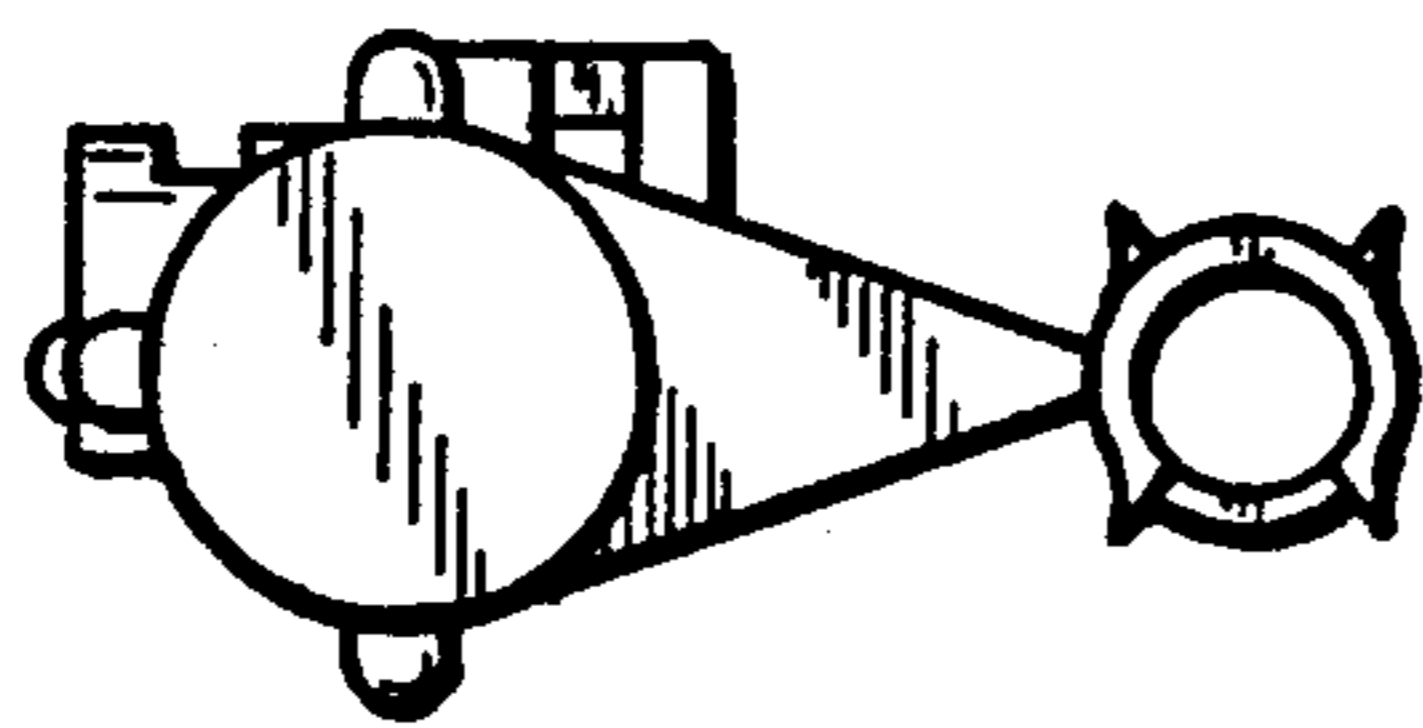
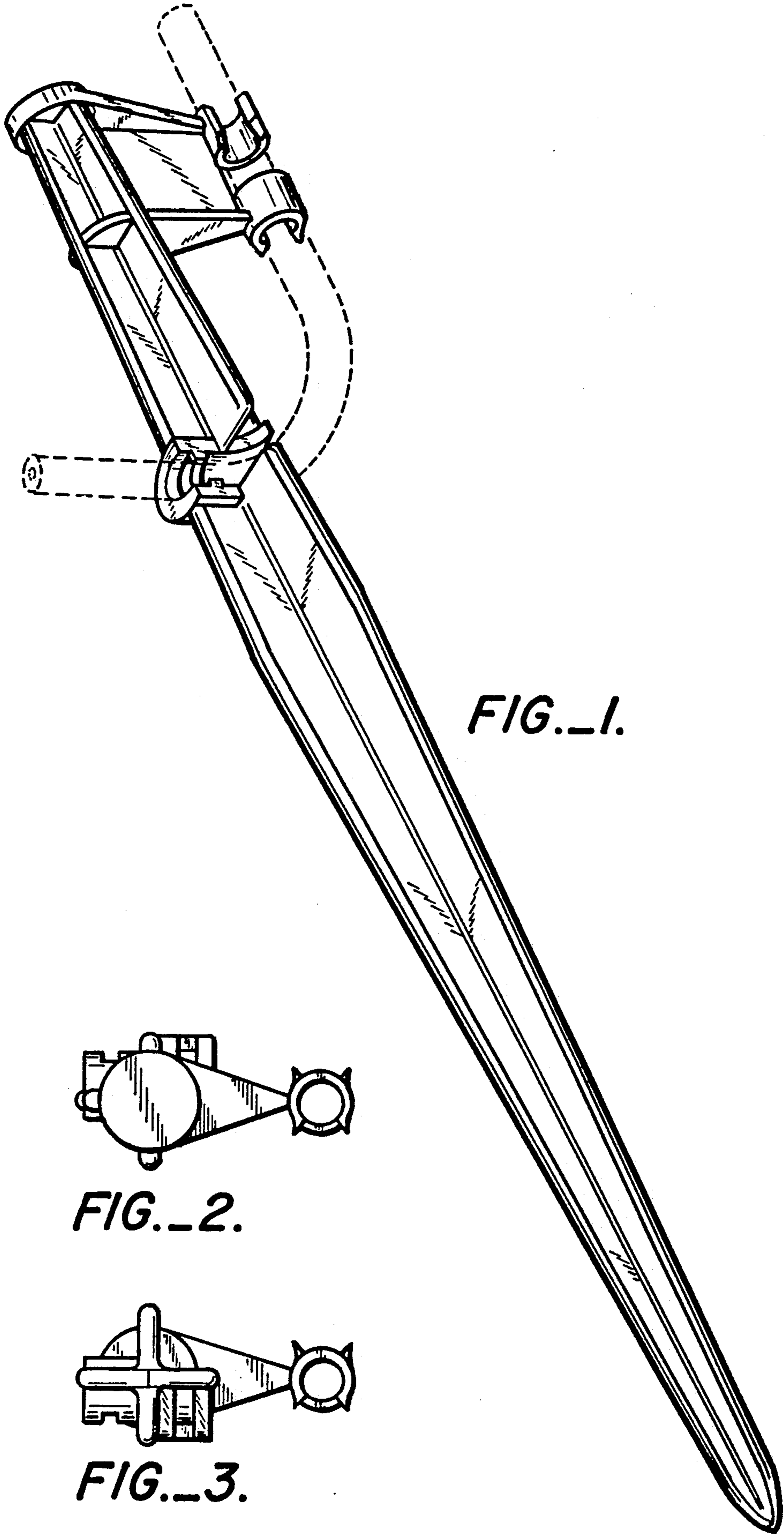

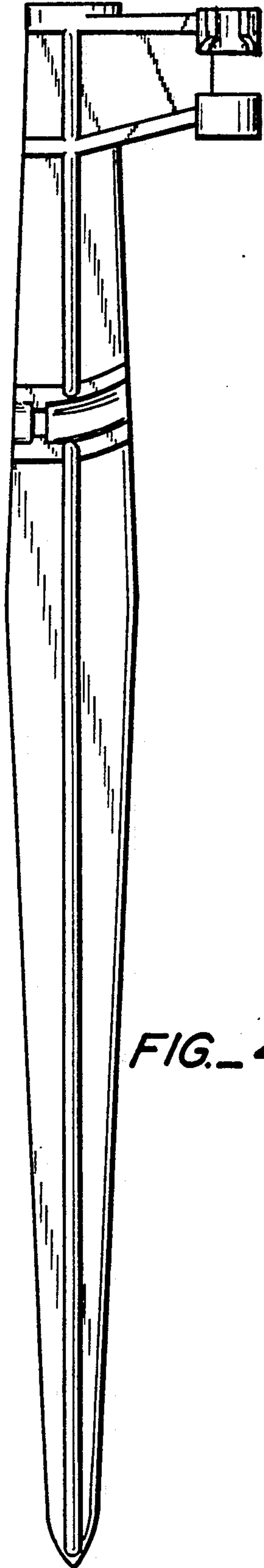

FIG. 4

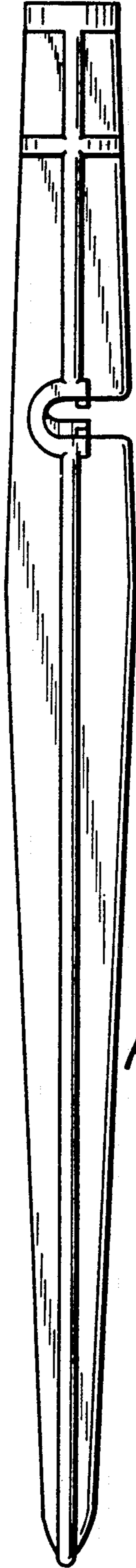

FIG. 5



FIG. 6

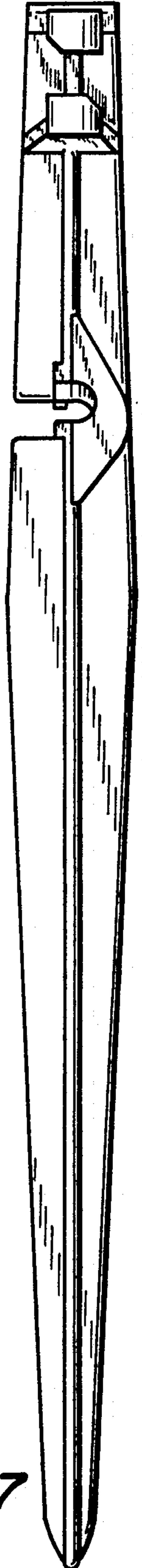

FIG. 7