

United States Patent [19]

Bridges et al.

[11] Patent Number: **Des. 316,332**

[45] Date of Patent: **** Apr. 23, 1991**

[54] CONTAINER

[75] Inventors: **John A. Bridges, Nashville; Richard D. Booten, Brentwood, both of Tenn.**

[73] Assignee: **Aladdin Industries Inc., Nashville, Tenn.**

[*] Notice: The portion of the term of this patent subsequent to Apr. 23, 2005 has been disclaimed.

[**] Term: **14 Years**

[21] Appl. No.: **260,666**

[22] Filed: **Oct. 21, 1988**

[52] U.S. Cl. **D3/74; D3/30.1; D9/424**

[58] Field of Search **D9/424, 425, 426, 420, D9/423, 443, 337; D3/30.1, 73, 74, 77, 76, 70; 220/4 B; 206/216, 223, 541, 545, 549; D7/602**

[56] **References Cited**

U.S. PATENT DOCUMENTS

D. 280,467 9/1985 Mihojevich D3/76

D. 293,854 1/1988 Gibbs D3/76 X
D. 304,784 11/1989 Dewitt D3/76
3,171,700 3/1965 Parsell et al. 206/541
3,339,781 9/1967 Schurman et al. 206/545 X
4,106,597 8/1978 Shook et al. 206/545 X
4,336,883 6/1982 Krug et al. 206/545
4,550,813 11/1985 Browning 220/22 X

Primary Examiner—Bernard Ansher
Assistant Examiner—Prabhakar Deshmukh
Attorney, Agent, or Firm—Sandler, Greenblum & Bernstein

[57] CLAIM

The ornamental design for the container, as shown and described.

DESCRIPTION

FIG. 1 is a top plan view of the container showing our new design;
FIG. 2 is a bottom plan view thereof;
FIG. 3 is a left side elevation thereof;
FIG. 4 is a right side elevation thereof;
FIG. 5 is a front elevation thereof;
FIG. 6 is a rear elevation thereof; and
FIG. 7 is a top plan view thereof; in open position.

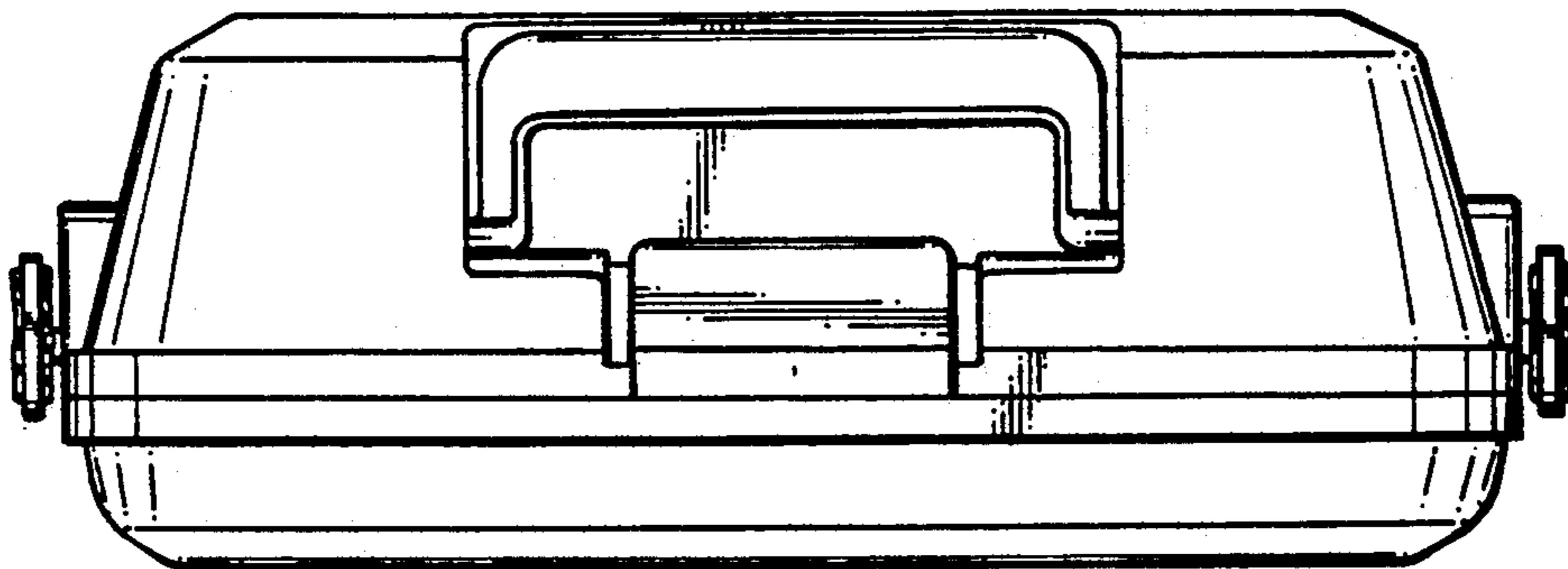

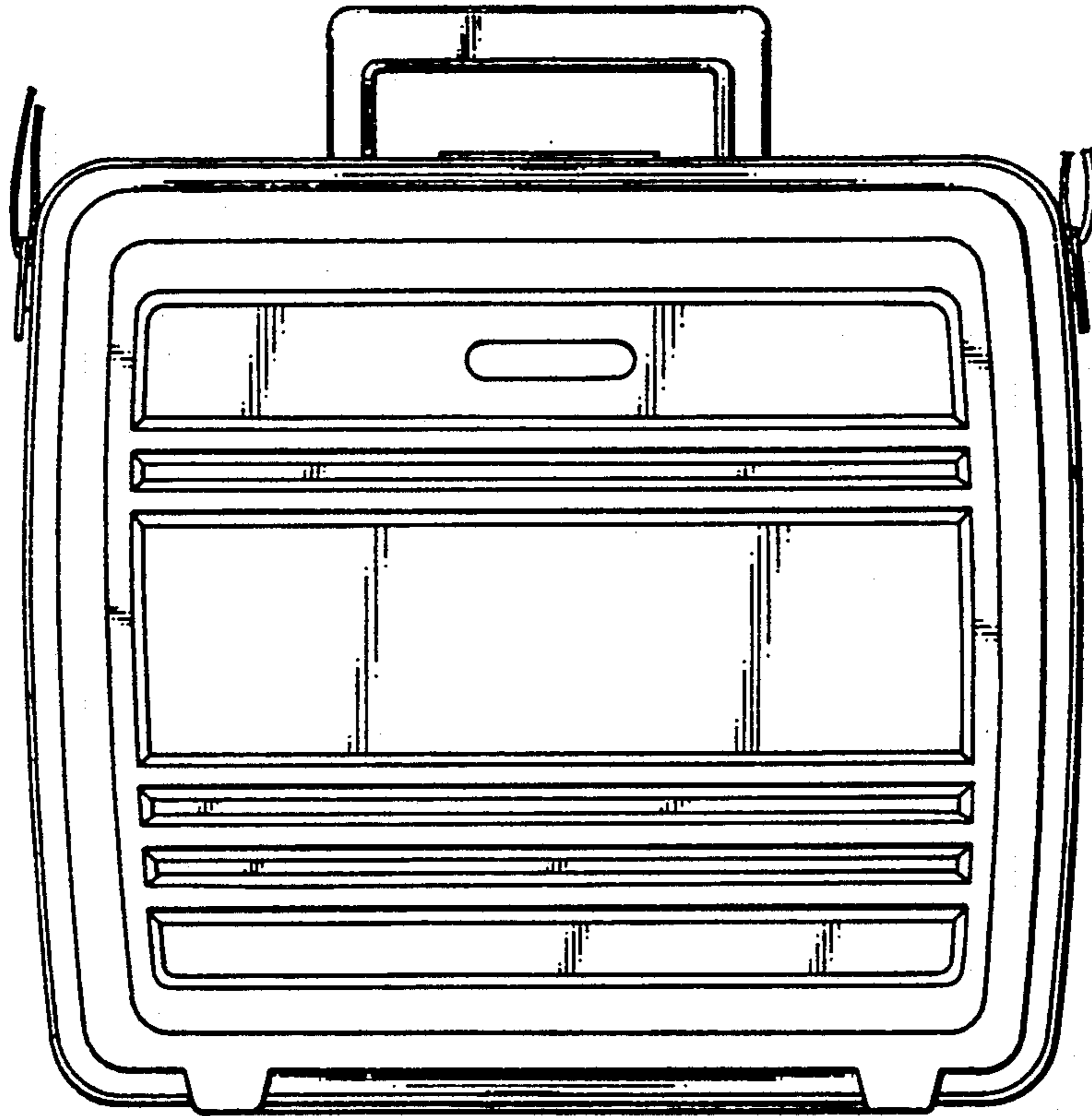

Fig. 1

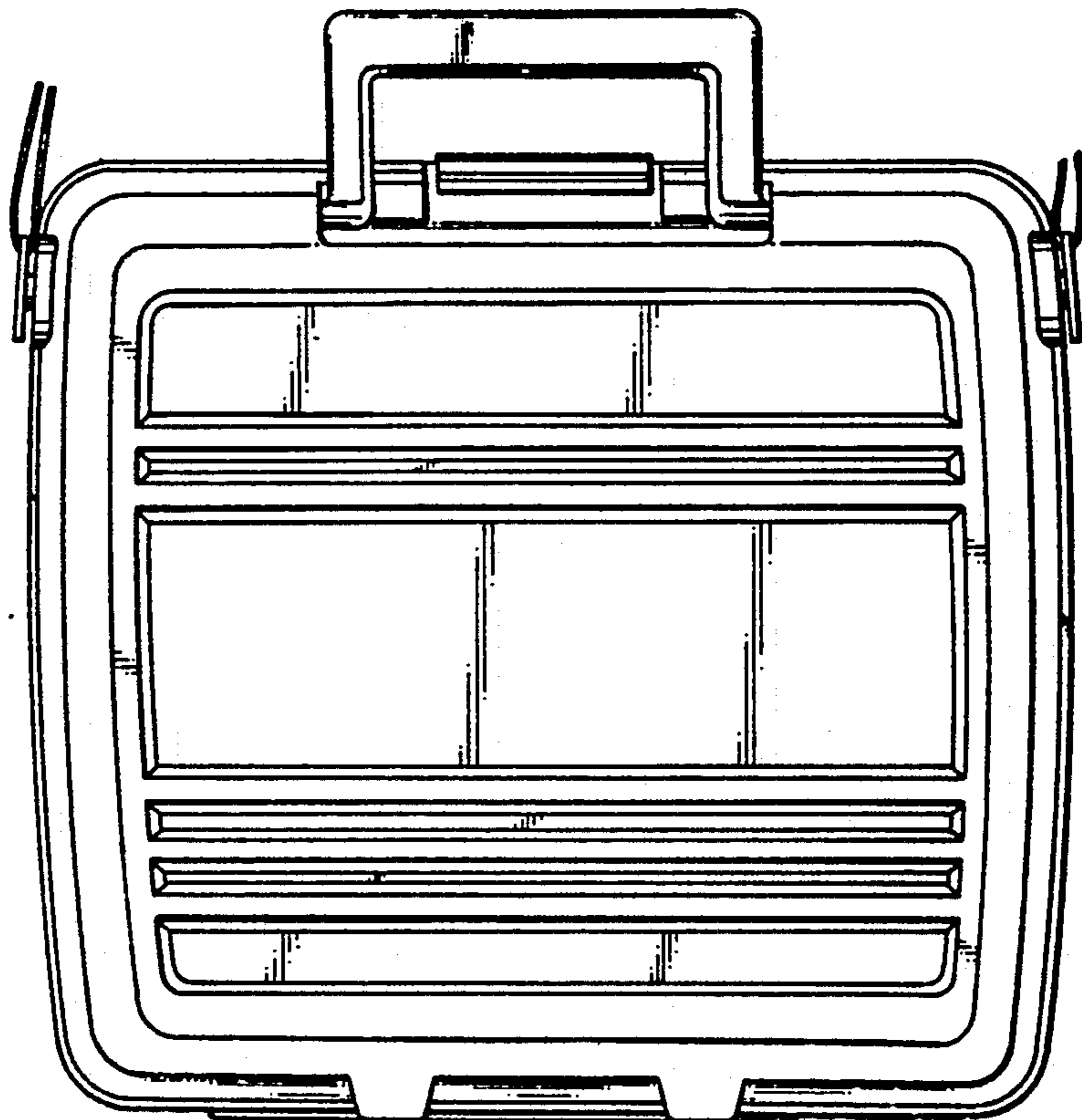

Fig. 2

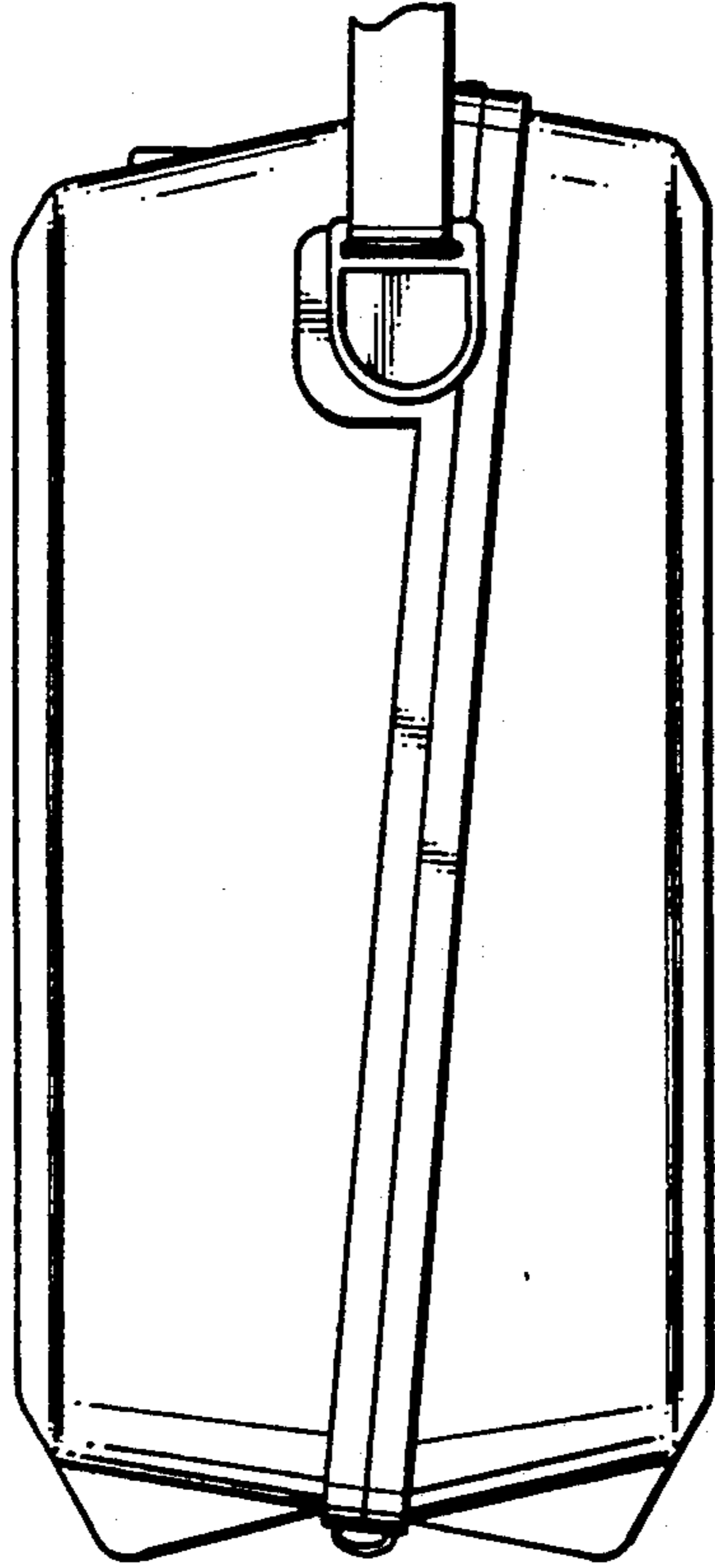

Fig. 3

Fig. 4

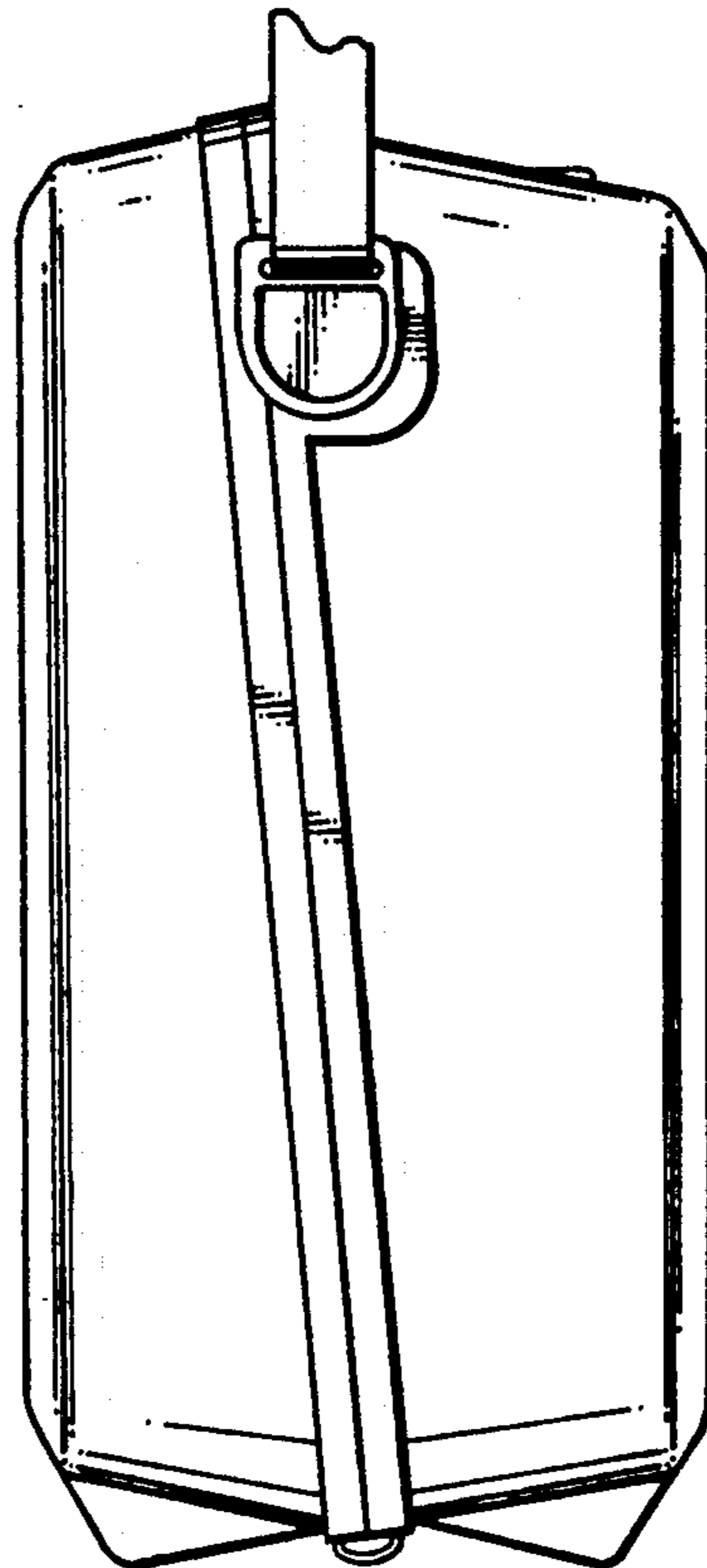

Fig. 5

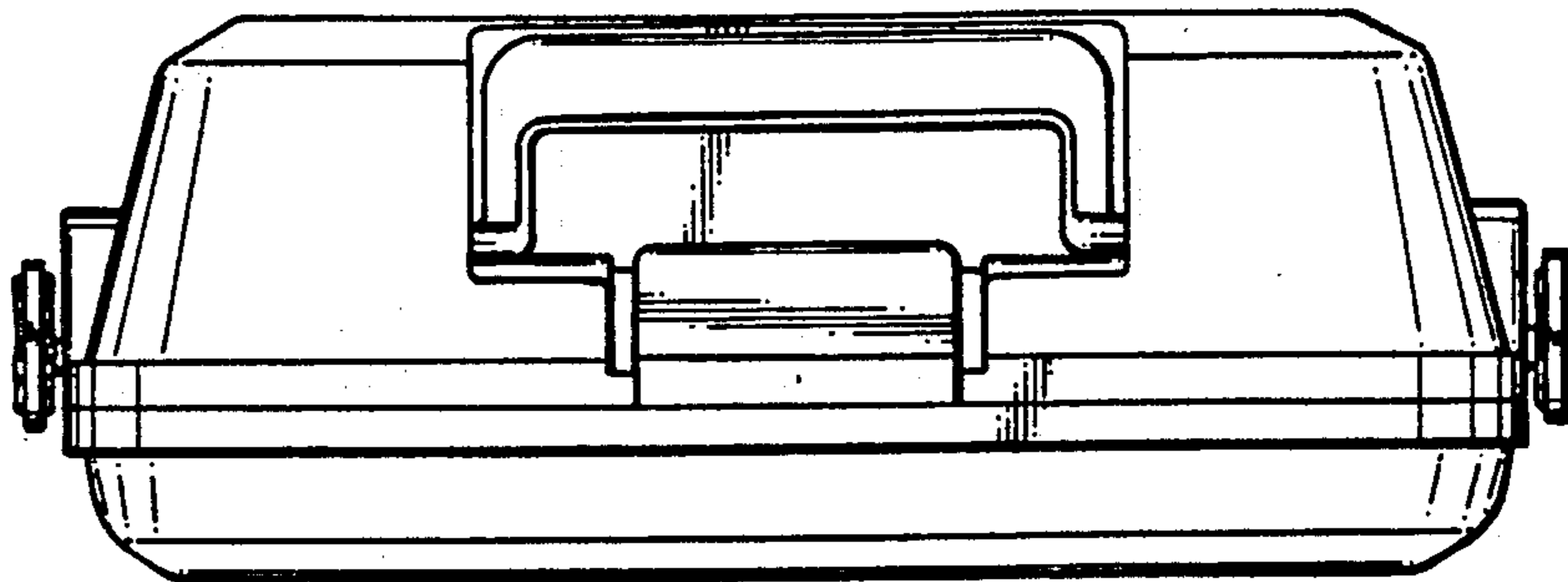

Fig. 6

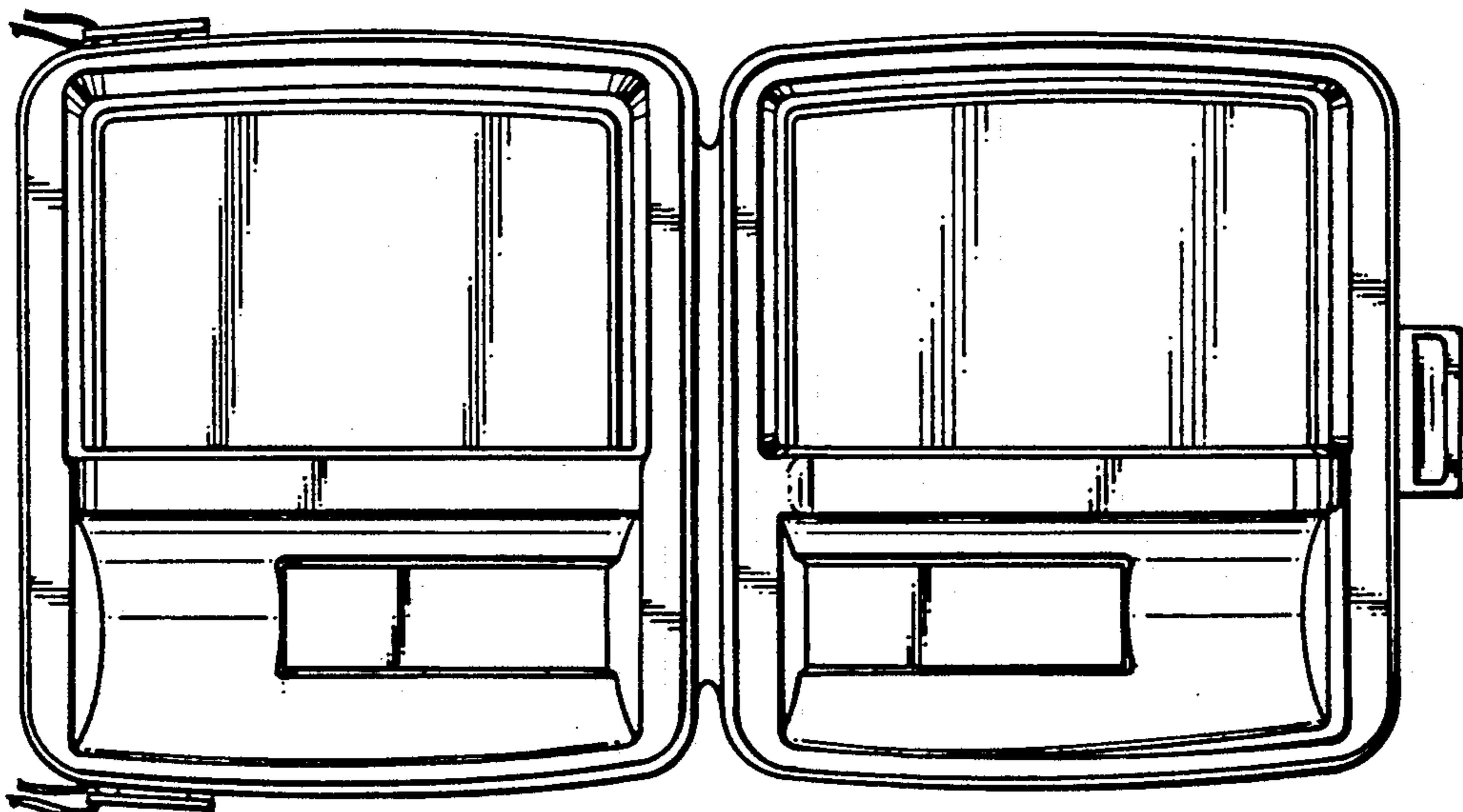
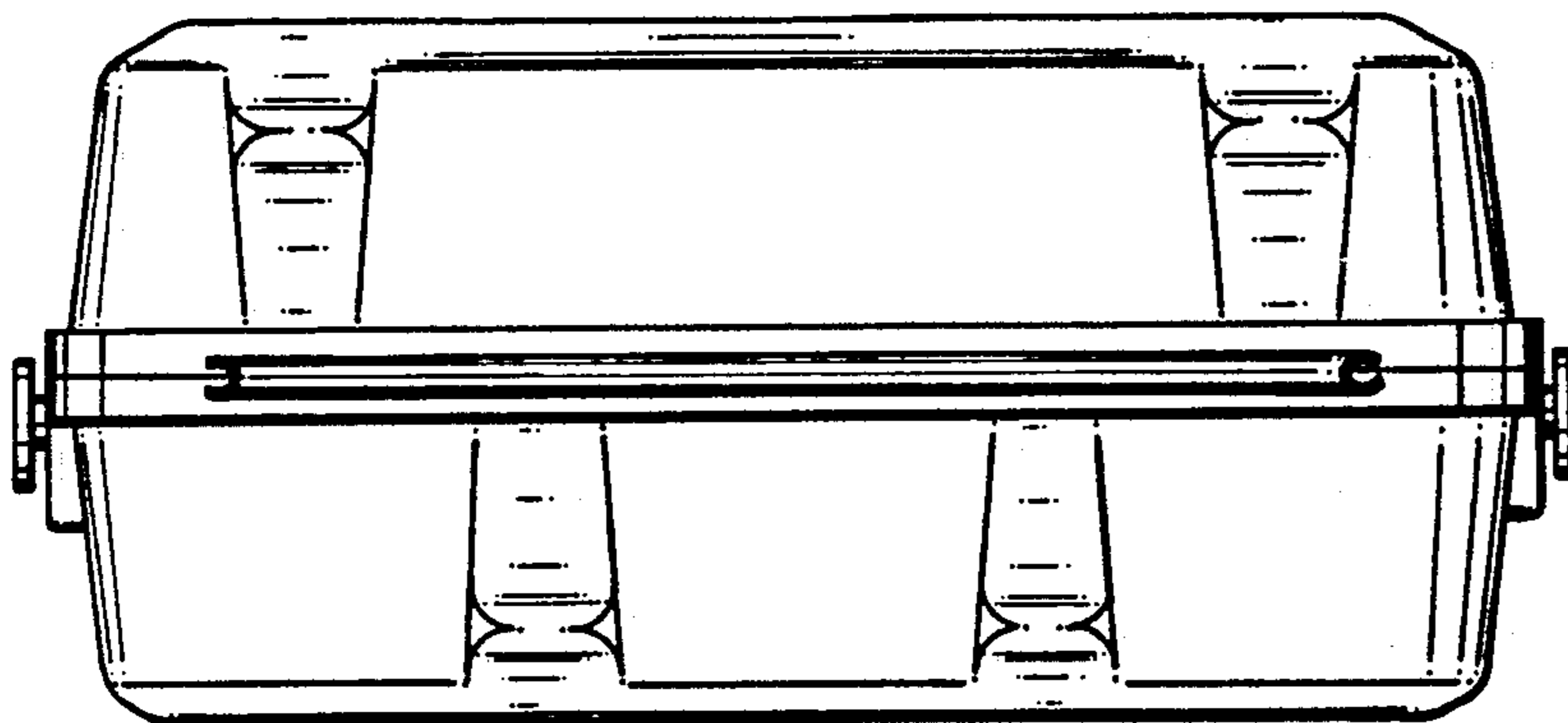

Fig. 7