

[54] FISHING ROD AND REEL HOLDER

[76] Inventor: Homer L. Craft, 6143 Ivanhoe, Bartlett, Tenn. 38134

[\*\*] Term: 14 Years

[21] Appl. No.: 250,125

[22] Filed: Sep. 27, 1988

[52] U.S. Cl. .... D3/38

[58] Field of Search ..... D3/100, 38; 43/26, 57.1, 43/57.3; 206/315.11; D22/147

[56] References Cited

U.S. PATENT DOCUMENTS

D. 160,520	10/1950	Mowat	.....	D3/38
D. 238,825	2/1976	Michal	.....	D3/38
D. 248,253	6/1978	Sugimoto	.....	D3/38
D. 254,696	6/1980	Adams	.....	D3/38
D. 284,423	7/1986	McCallum	.....	D3/38
2,650,449	9/1953	Suring	.....	43/26
2,723,482	11/1955	Marten	.....	43/26
2,869,277	1/1959	reithaupt	.....	43/26
2,902,790	9/1959	Harvey	.....	43/26
3,641,697	2/1972	Heidtman et al.	.....	43/26

FOREIGN PATENT DOCUMENTS

1419803	10/1965	France	.....	46/26
---------	---------	--------	-------	-------

Primary Examiner—Louis S. Zarfes

Assistant Examiner—M. N. Pandozzi

Attorney, Agent, or Firm—Walker & McKenzie

[57] CLAIM

The ornamental design for a fishing rod and reel holder, as shown and described.

DESCRIPTION

FIG. 1 is a front elevational view of a fishing rod and reel holder showing a first embodiment of my new design;

FIG. 2 is a bottom plan view thereof;

FIG. 3 is a rear elevational view thereof;

FIG. 4 is a top plan view thereof;

FIG. 5 is a left end elevational view thereof;

FIG. 6 is a right end elevational view thereof;

FIG. 7 is a perspective view thereof;

FIG. 8 is a front elevational view of a fishing rod and reel holder showing a second embodiment of my new design;

FIG. 9 is a bottom plan view thereof;

FIG. 10 is a rear elevational view thereof;

FIG. 11 is a top plan view thereof;

FIG. 12 is a left end elevational view;

FIG. 13 is a right end elevational view;

FIG. 14 is a perspective view thereof;

FIG. 15 is a front elevational view of the first embodiment;

FIG. 16 is a rear elevational view of the second embodiment.

The broken line showing of a casting rod and reel in FIGS. 14 and 7 is for illustrative purposes only and forms no part of the claimed design.

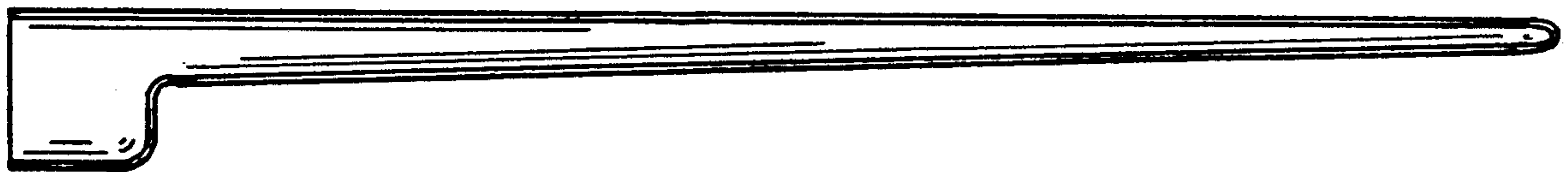

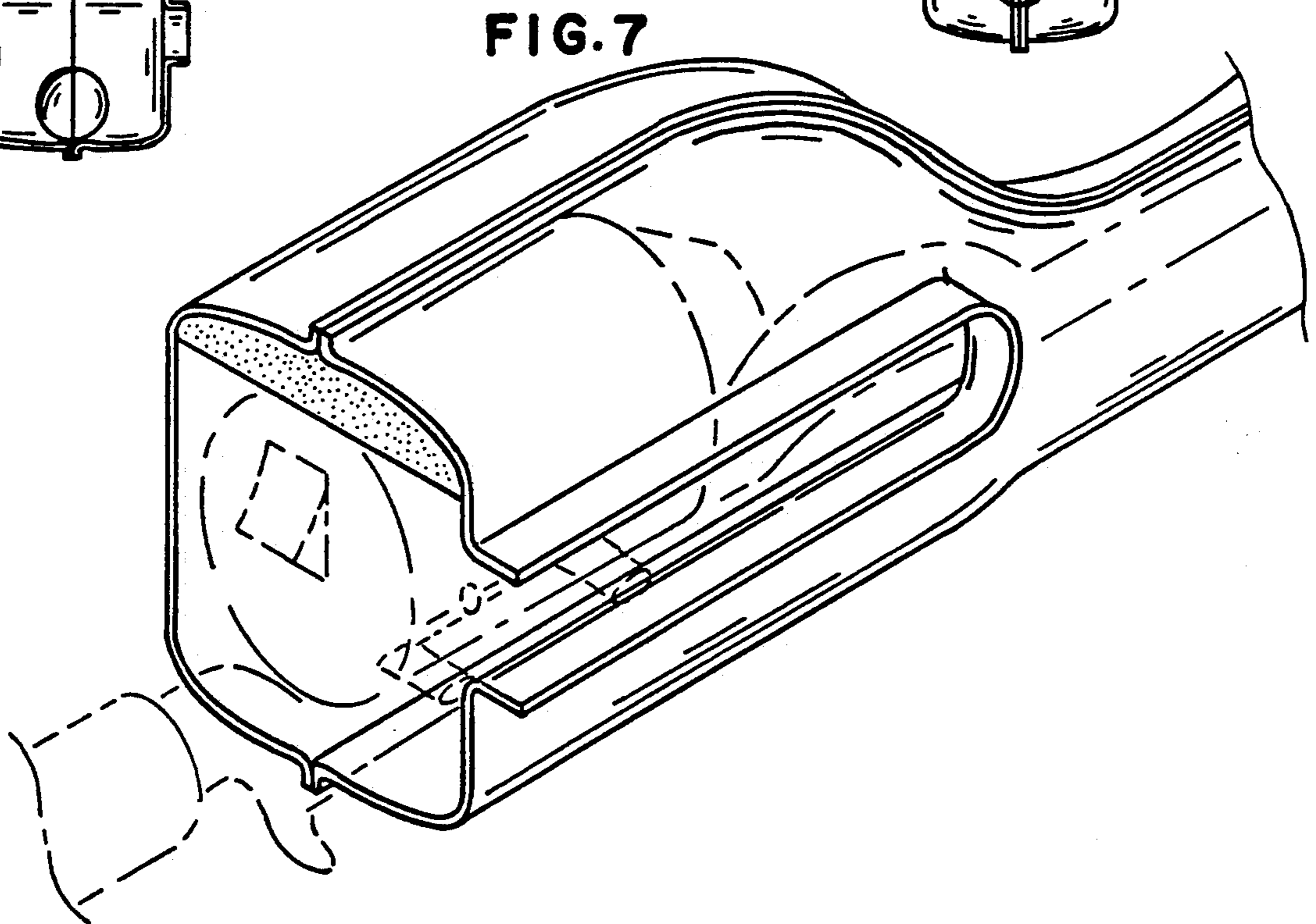
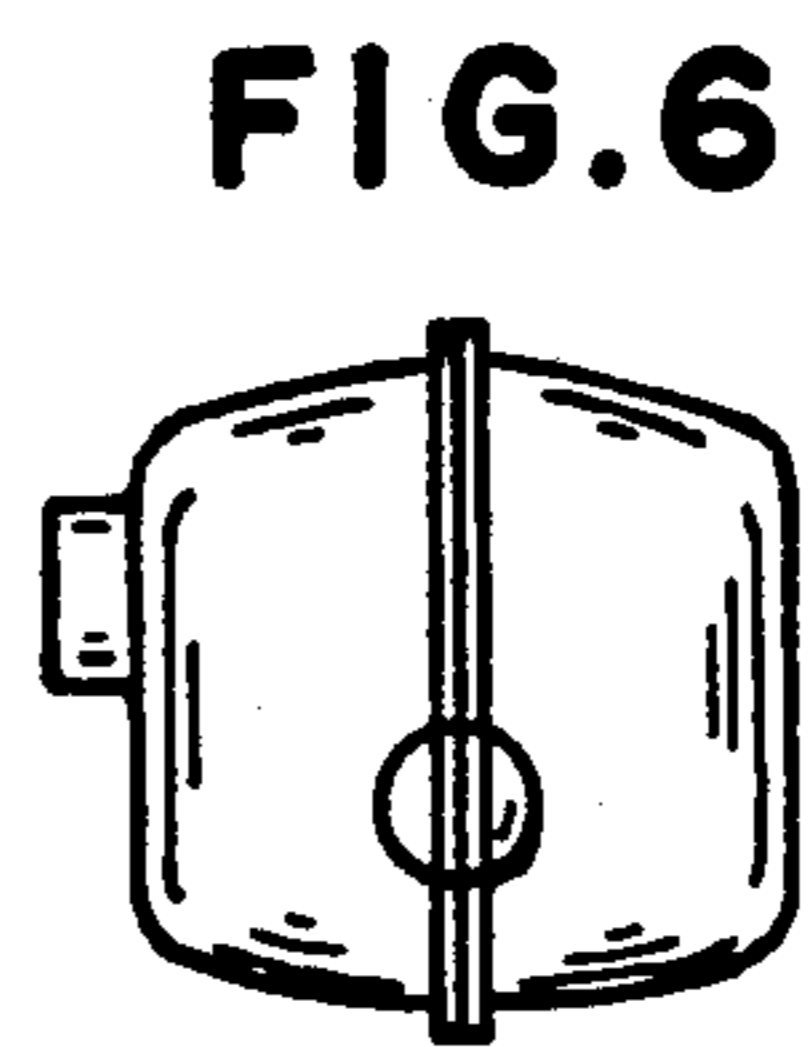
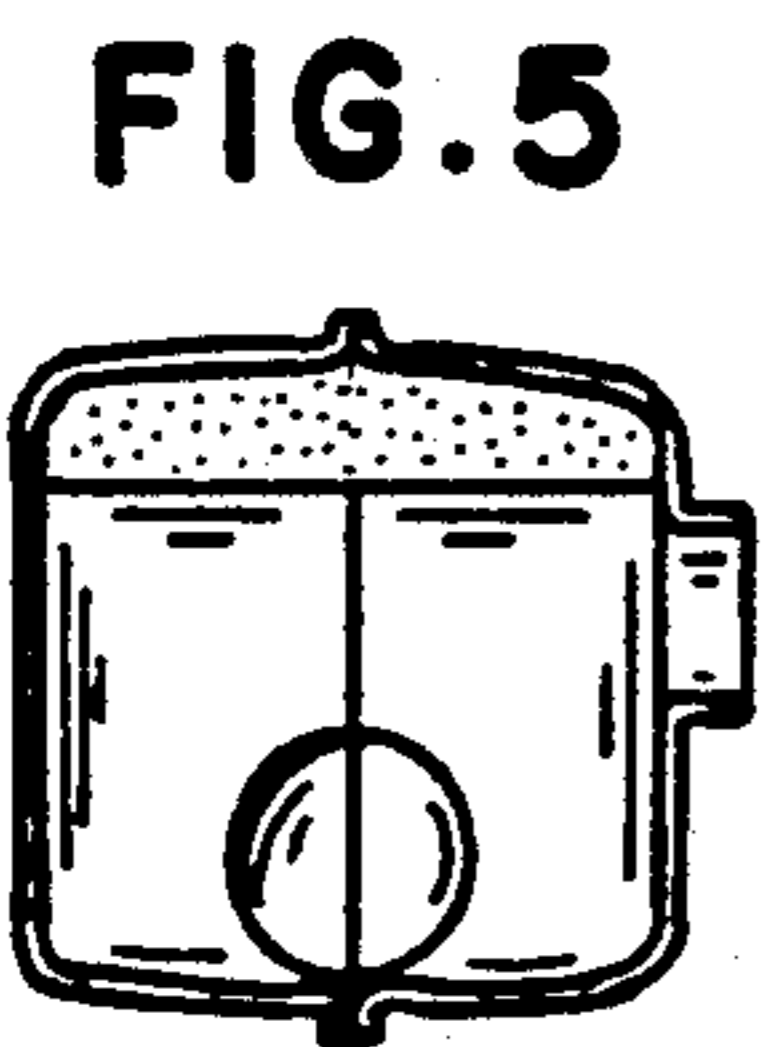
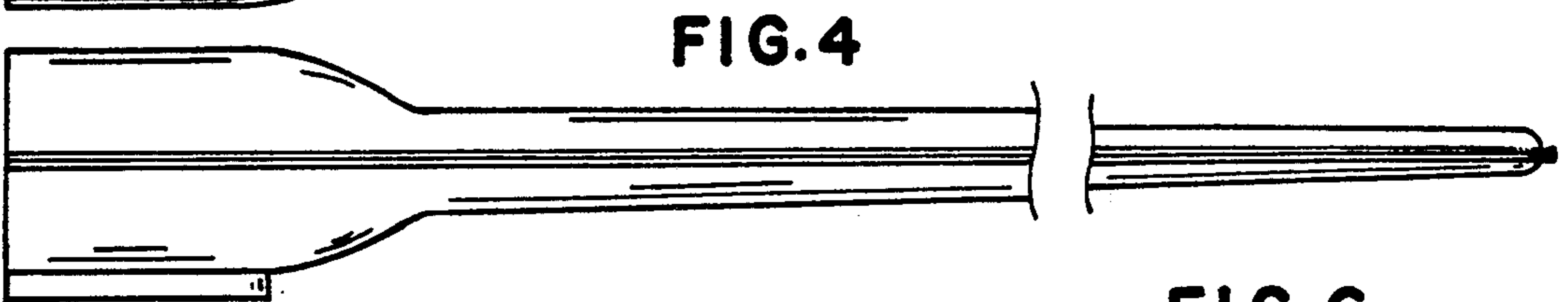
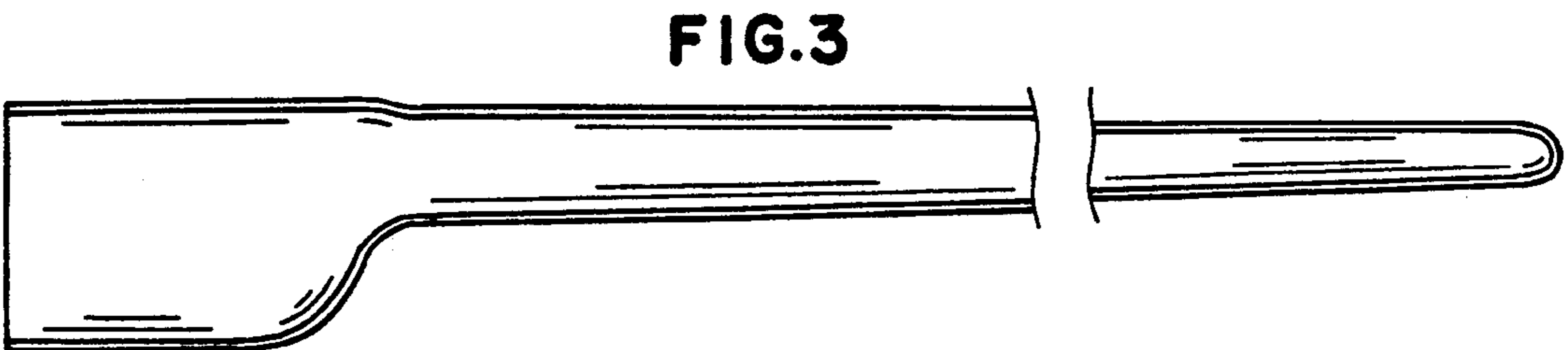
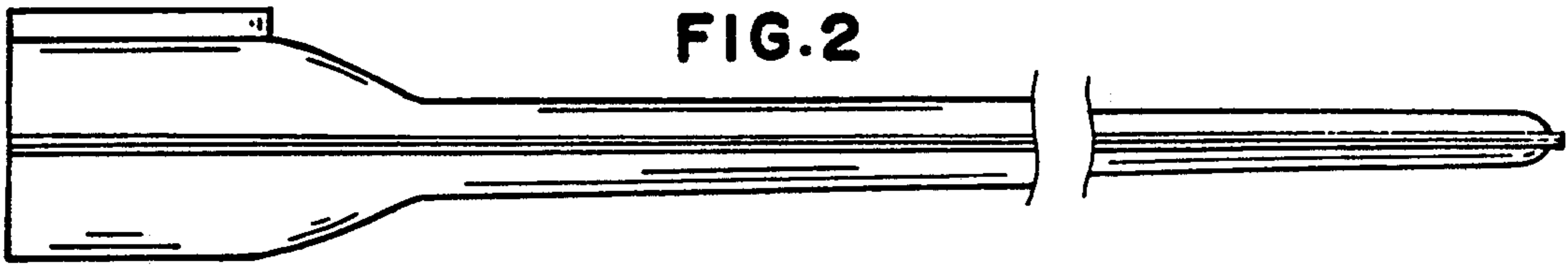
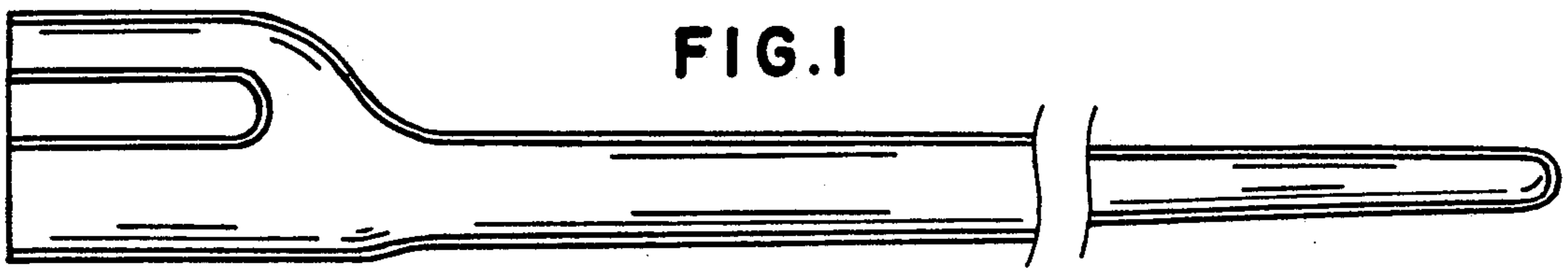

FIG. 8

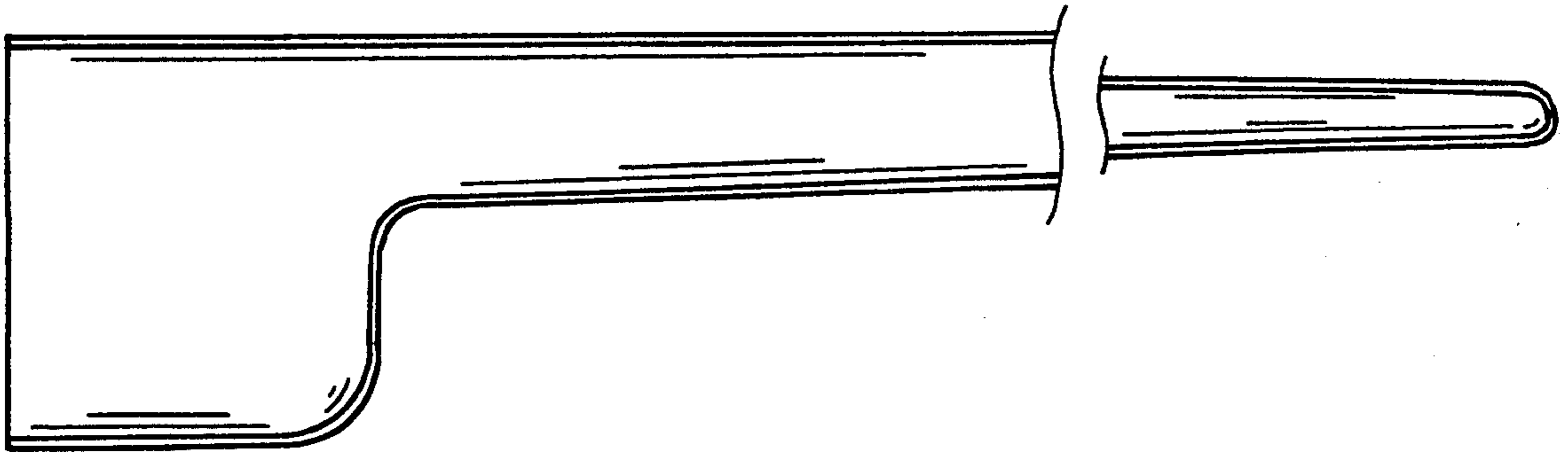

FIG. 9

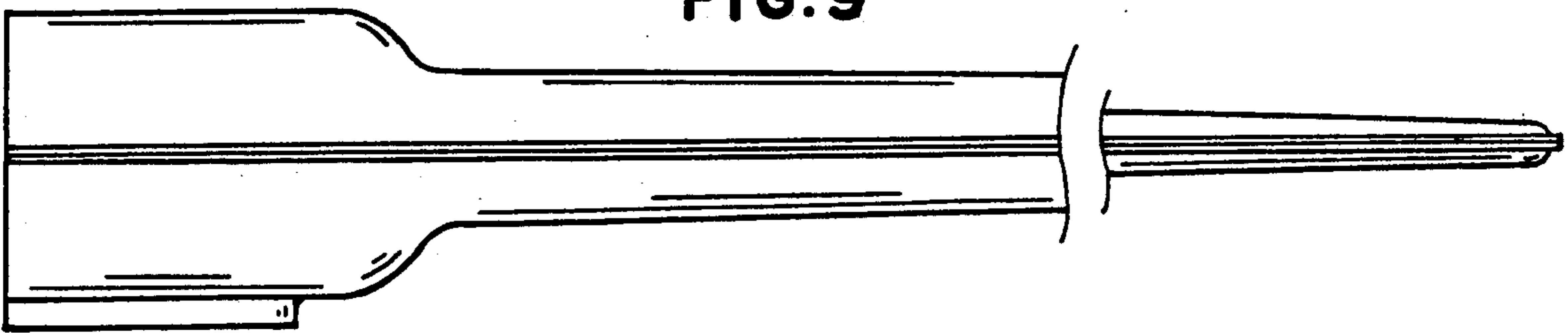

FIG. 10

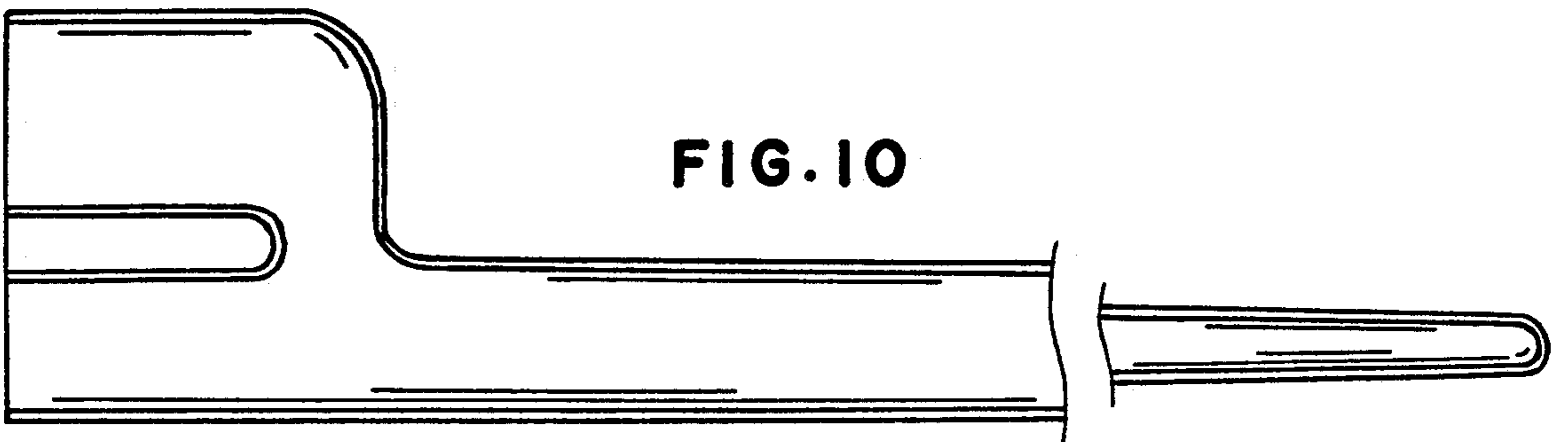

FIG. 11

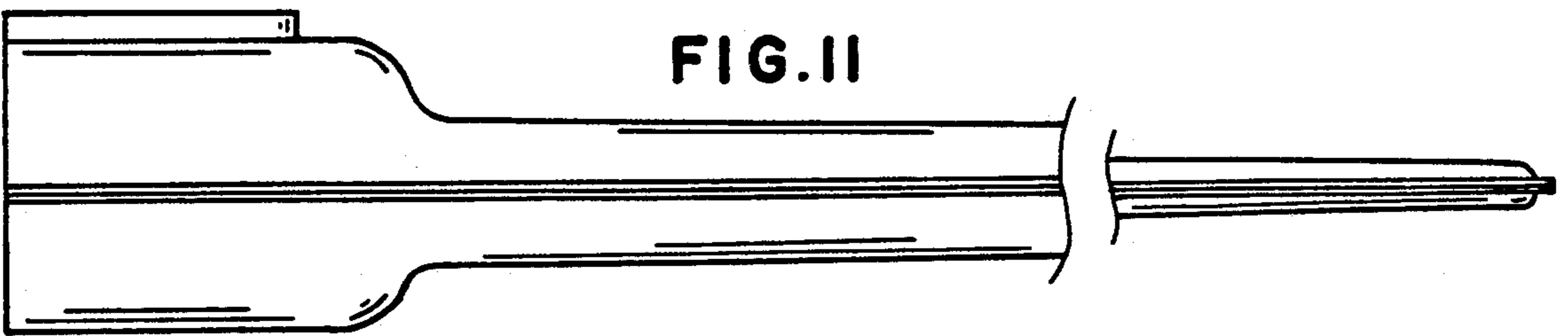

FIG. 12

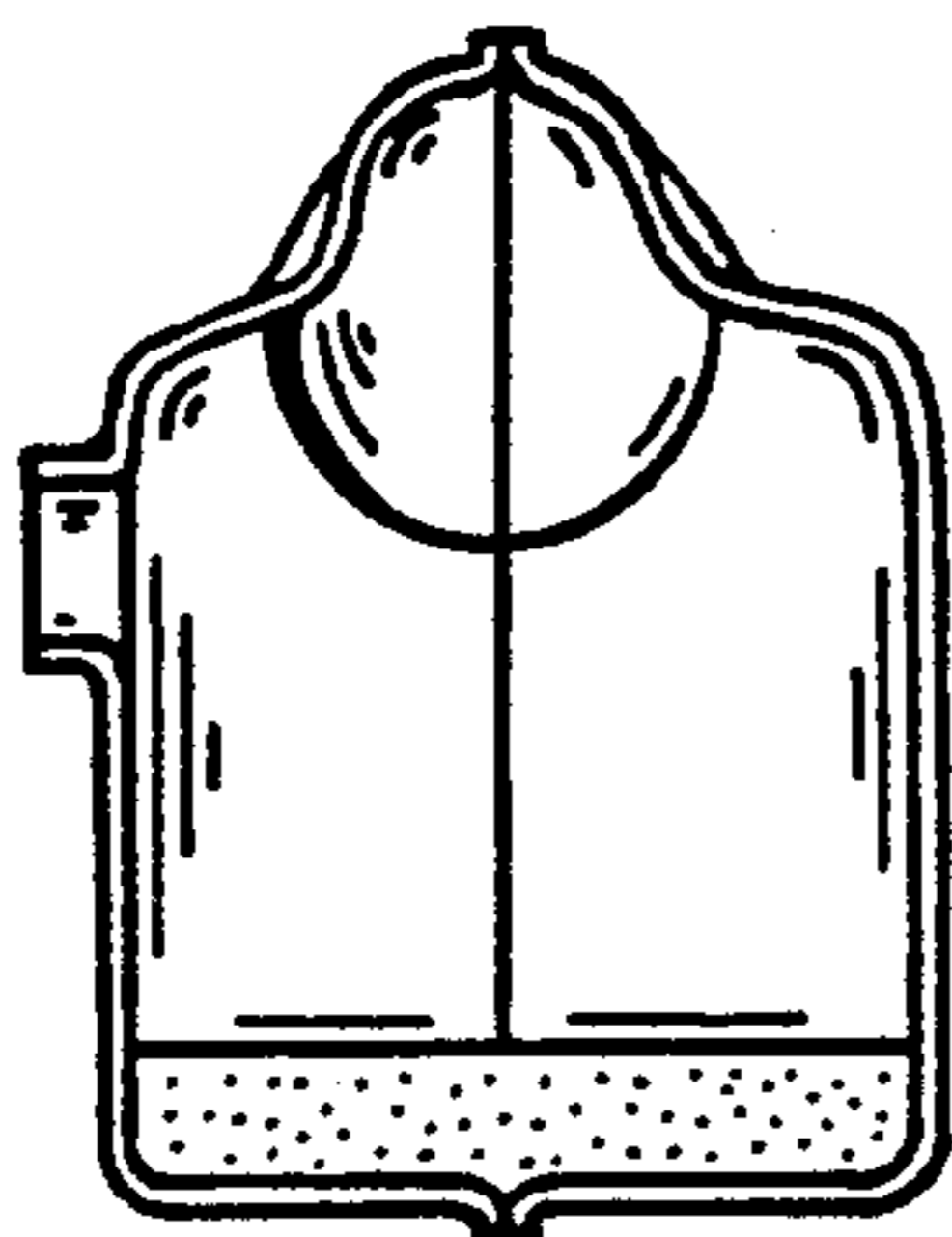

FIG. 13

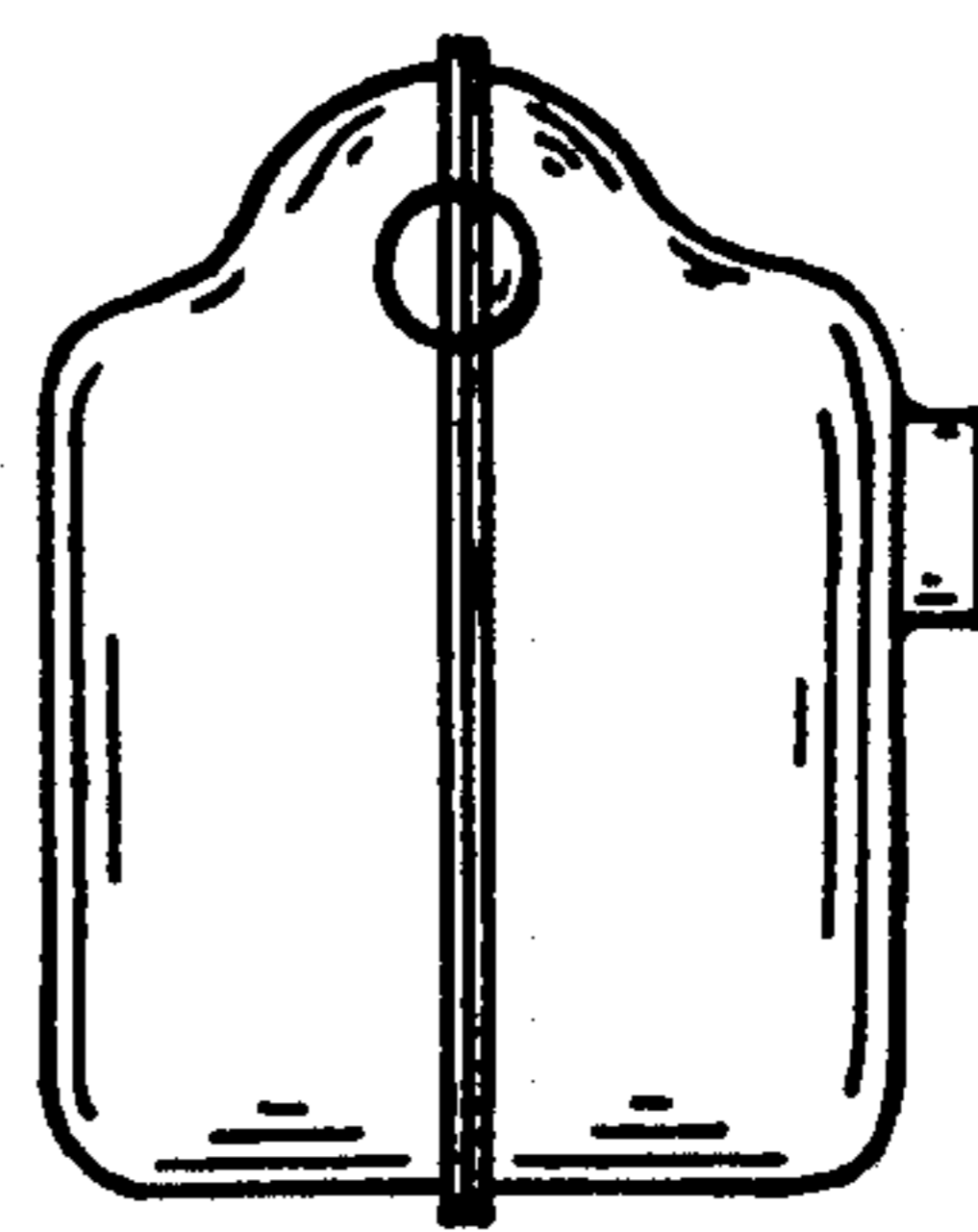

FIG.14

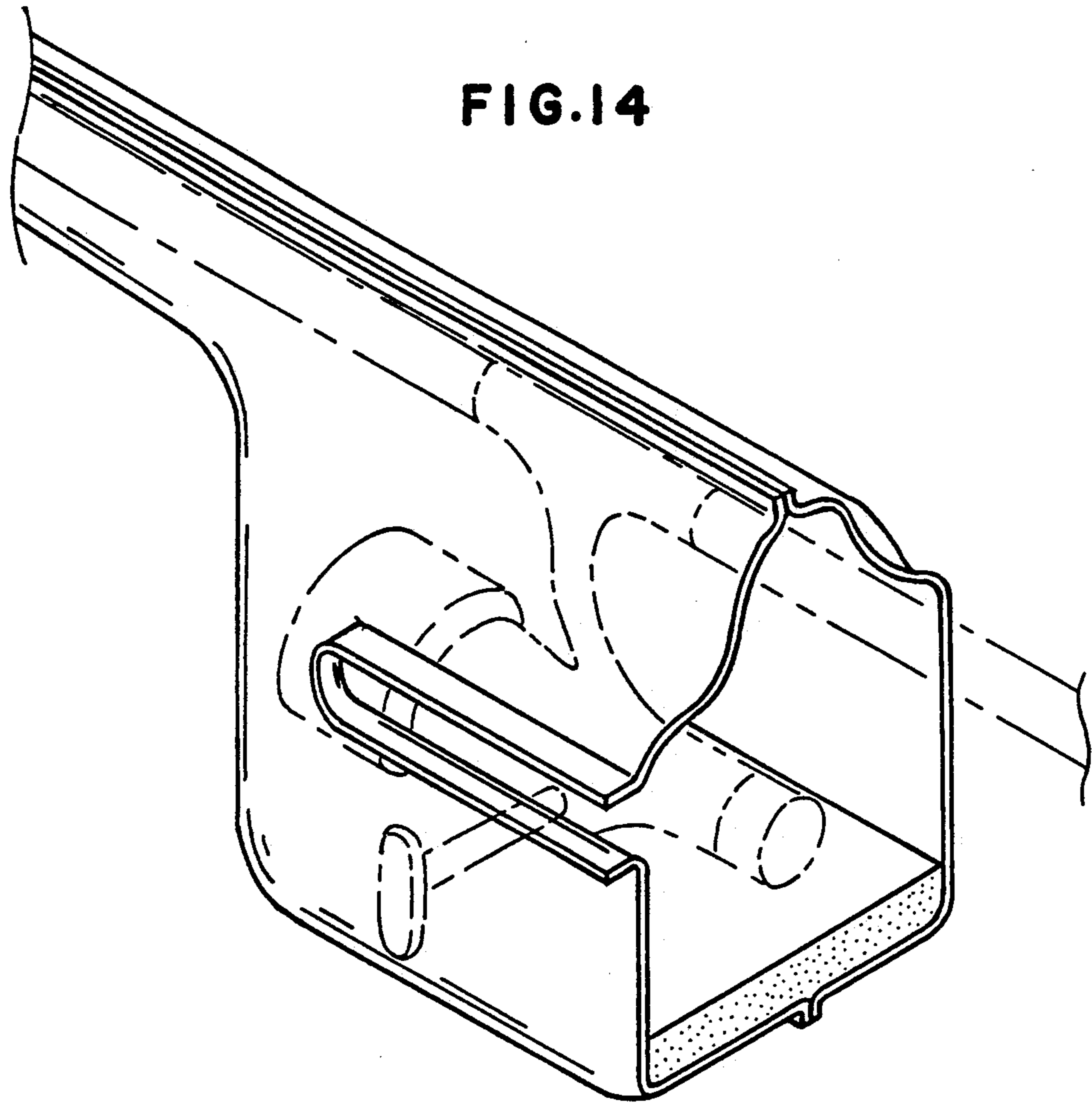

FIG.15

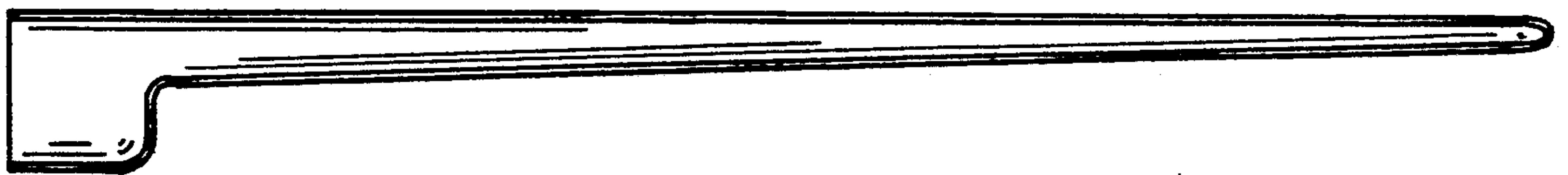

FIG.16

