

[54] SHELF UNIT

[75] Inventor: Peter M. Y. Kee, Happy Valley, Hong Kong

[73] Assignee: Rosalco, Inc., Louisville, Ky.

[*] Notice: The portion of the term of this patent subsequent to Jun. 26, 2004 has been disclaimed.

[**] Term: 14 Years

[21] Appl. No.: 428,653

[22] Filed: Oct. 30, 1989

Related U.S. Application Data

[62] Division of Ser. No. 295,566, Jan. 10, 1989.

[52] U.S. Cl. D6/479; D6/465

[58] Field of Search D6/462, 464, 465, 474, D6/477, 479; 211/182; D34/21

[56] References Cited

U.S. PATENT DOCUMENTS

- D. 191,249 8/1961 Gardner et al. D6/474
- D. 244,982 7/1977 Parra D6/474 X
- 4,821,893 4/1989 Wyatt 211/182

OTHER PUBLICATIONS

W. Bell & Co. Catalog 1987; items 1 and 4. Furniture/Today; Apr. 18, 1988; powell advertise. Beagle Manufacturing Co. Inc., p. 15.

Primary Examiner—Bruce W. Dunkins
Assistant Examiner—Jeffrey Asch
Attorney, Agent, or Firm—Rhodes, Coats & Bennett

[57] CLAIM

The ornamental design for a shelf unit, as shown and described.

DESCRIPTION

FIG. 1 is a front perspective view of a shelf unit showing my new design;
FIG. 2 is a rear perspective view of the shelf unit of FIG. 1;

FIG. 3 is a front elevational view of the shelf unit of FIG. 1;
 FIG. 4 is a front perspective view of a second embodiment of the shelf unit shown in FIG. 1;
 FIG. 5 is a rear perspective view of the shelf unit of FIG. 4;
 FIG. 6 is a front elevational view of the shelf unit of FIG. 4;
 FIG. 7 is a front perspective view of a third embodiment of the shelf unit shown in FIG. 1;
 FIG. 8 is a rear perspective view of the shelf unit of FIG. 7;
 FIG. 9 is a front elevational view of the shelf unit of FIG. 7;
 FIG. 10 is a front perspective view of a fourth embodiment of the shelf unit as shown in FIG. 1;
 FIG. 11 is a rear perspective view of the shelf unit of FIG. 10;
 FIG. 12 is a front elevational view of the shelf unit of FIG. 10;
 FIG. 13 is a front perspective view of a fifth embodiment of the shelf unit shown in FIG. 1;
 FIG. 14 is a rear perspective view of the shelf unit of FIG. 13;
 FIG. 15 is a front elevational view of the shelf unit of FIG. 13;
 FIG. 16 is a front perspective view of a sixth embodiment of the shelf unit shown in FIG. 1;
 FIG. 17 is a rear perspective view of the shelf unit of FIG. 16;
 FIG. 18 is a front elevational view of the shelf unit of FIG. 16;
 FIG. 19 is a front perspective view of a seventh embodiment of the shelf unit shown in FIG. 1;
 FIG. 20 is a rear perspective view of the shelf unit of FIG. 19;
 FIG. 21 is a front elevational view of the shelf unit of FIG. 19;
 FIG. 22 is a front perspective view of an eighth embodiment of the shelf unit shown in FIG. 1;
 FIG. 23 is a rear perspective view of the shelf unit of FIG. 22; and
 FIG. 24 is a front elevational view of the shelf unit of FIG. 22.

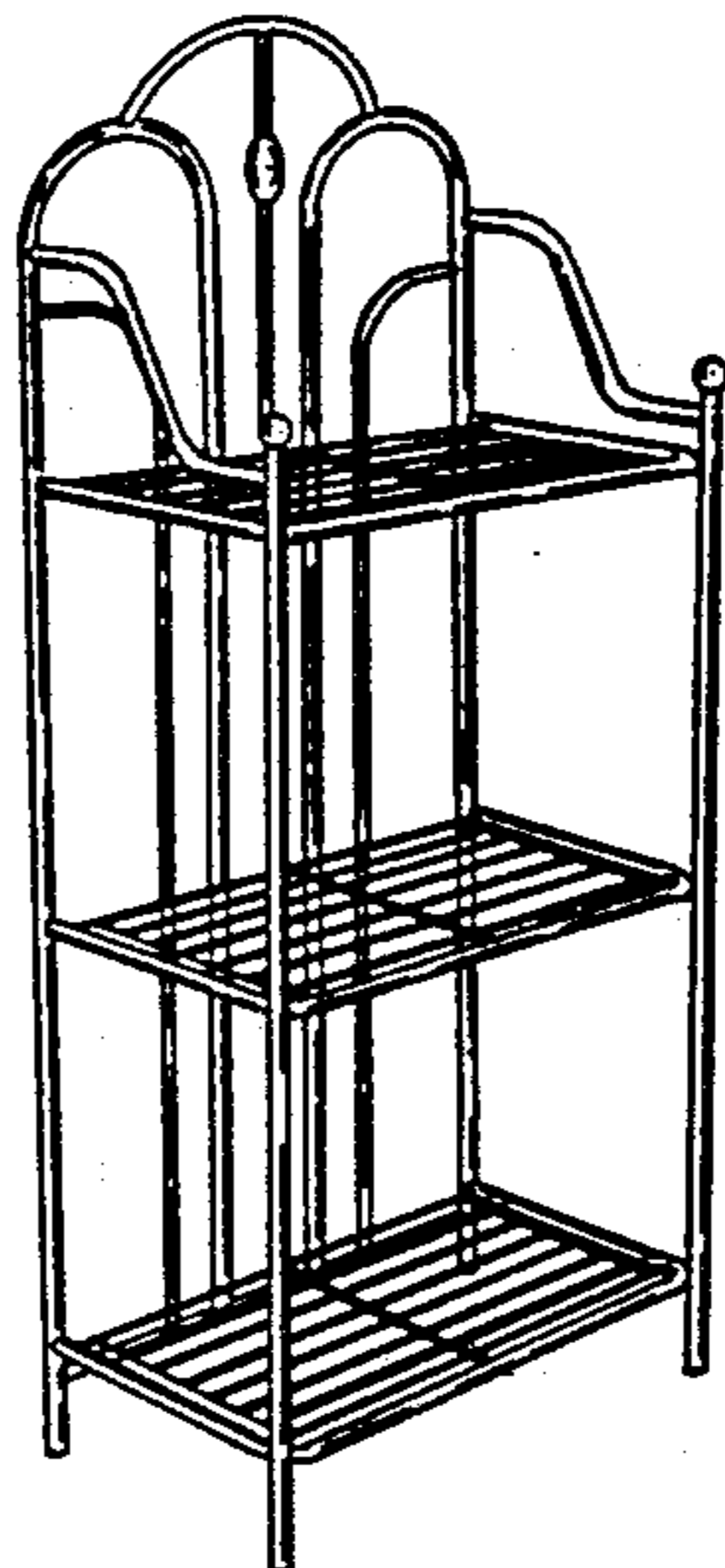

FIG. 3

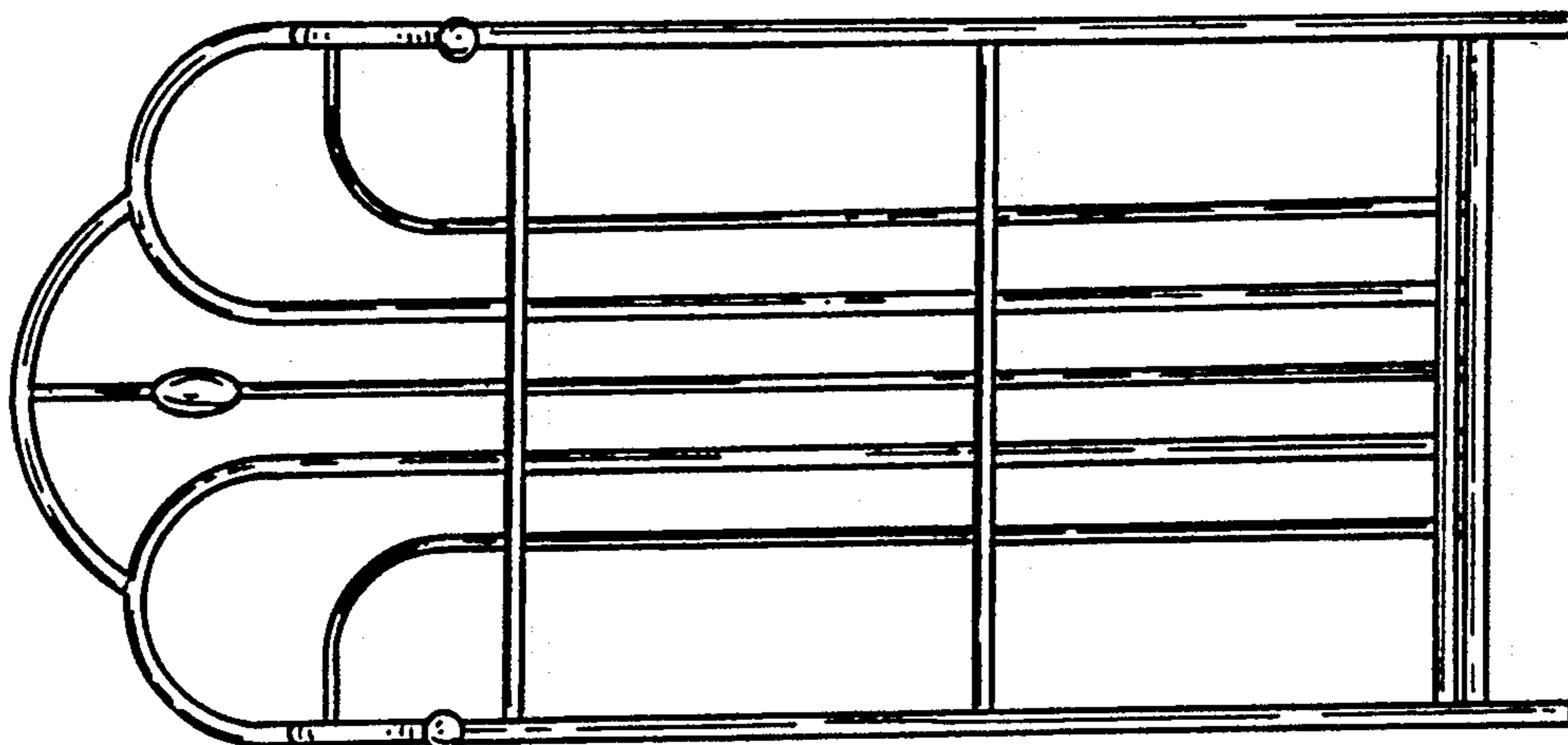

FIG. 2

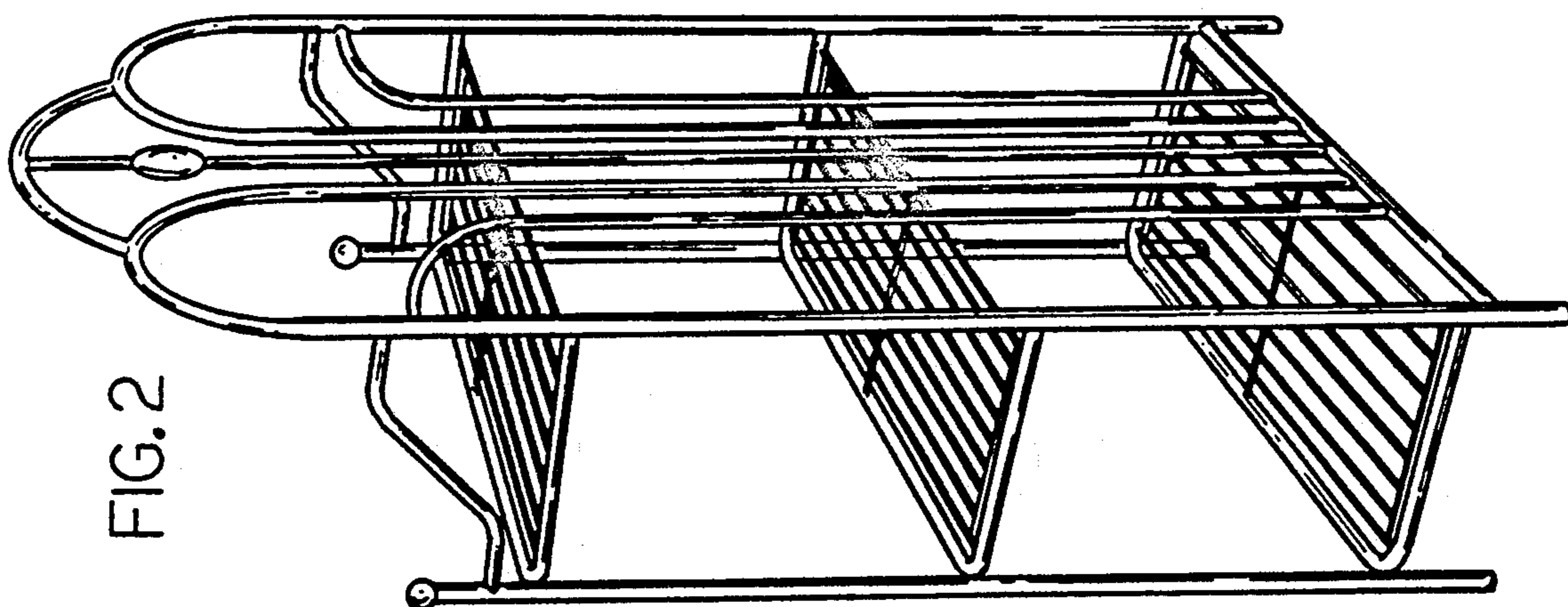
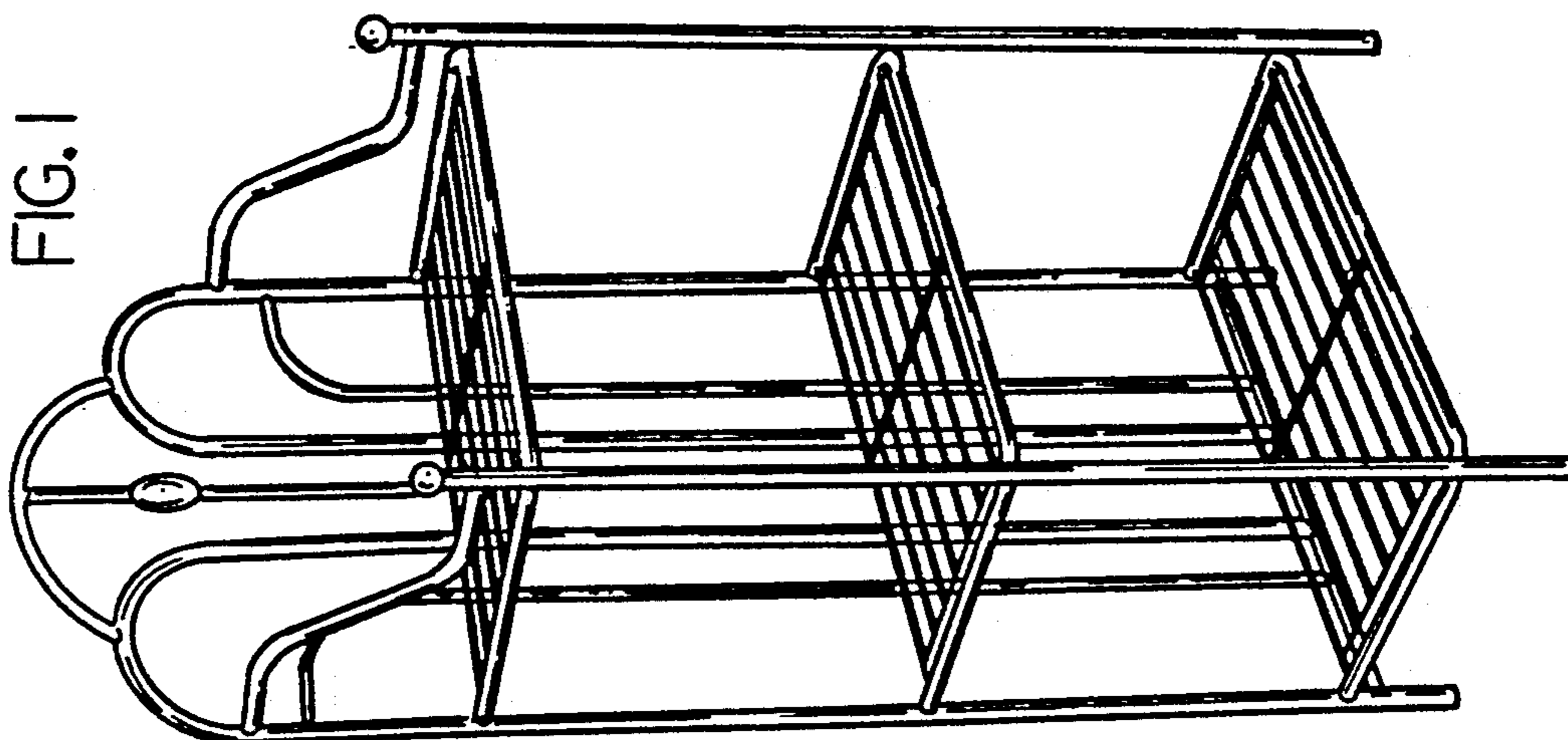

FIG. 1



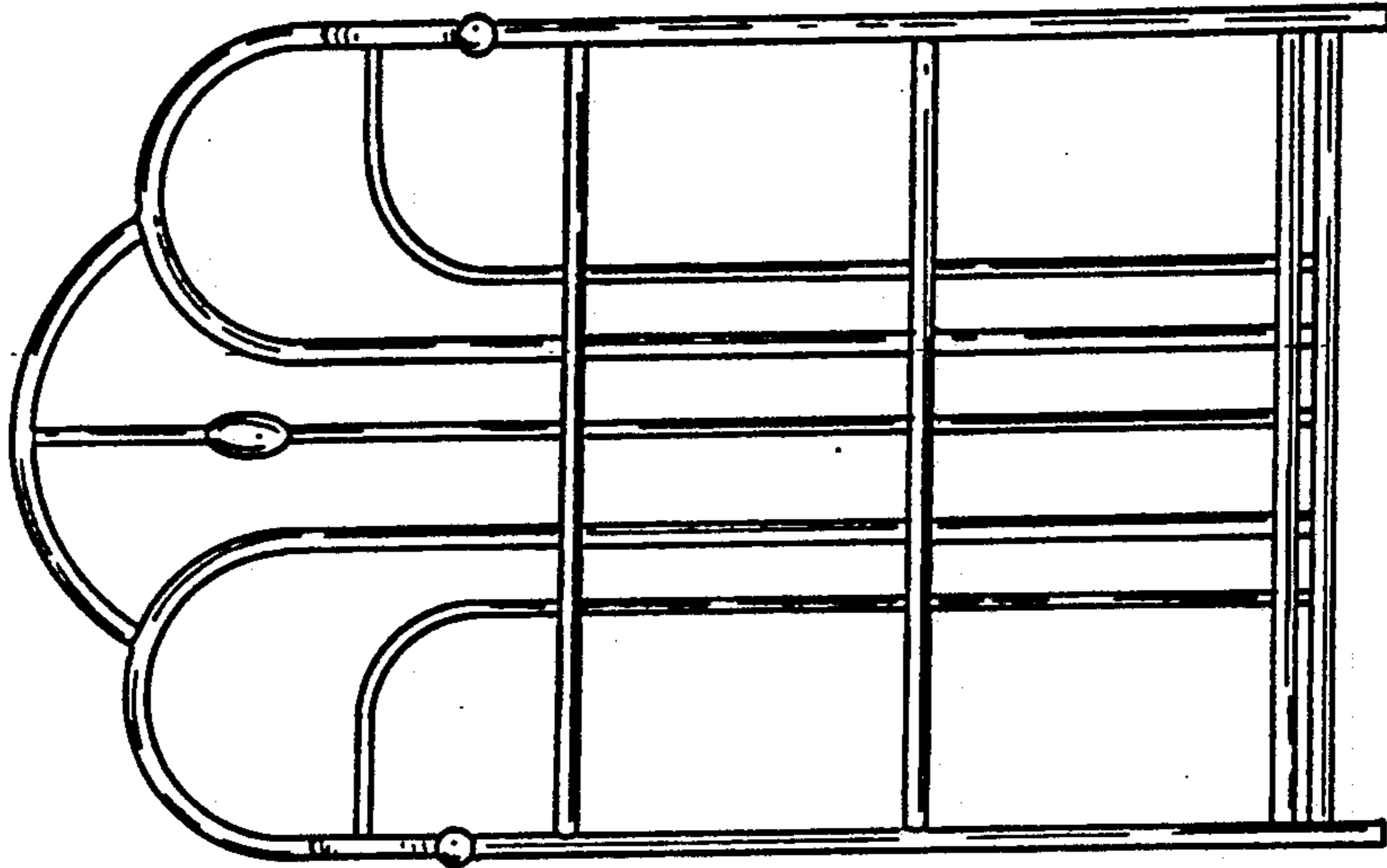

FIG. 6

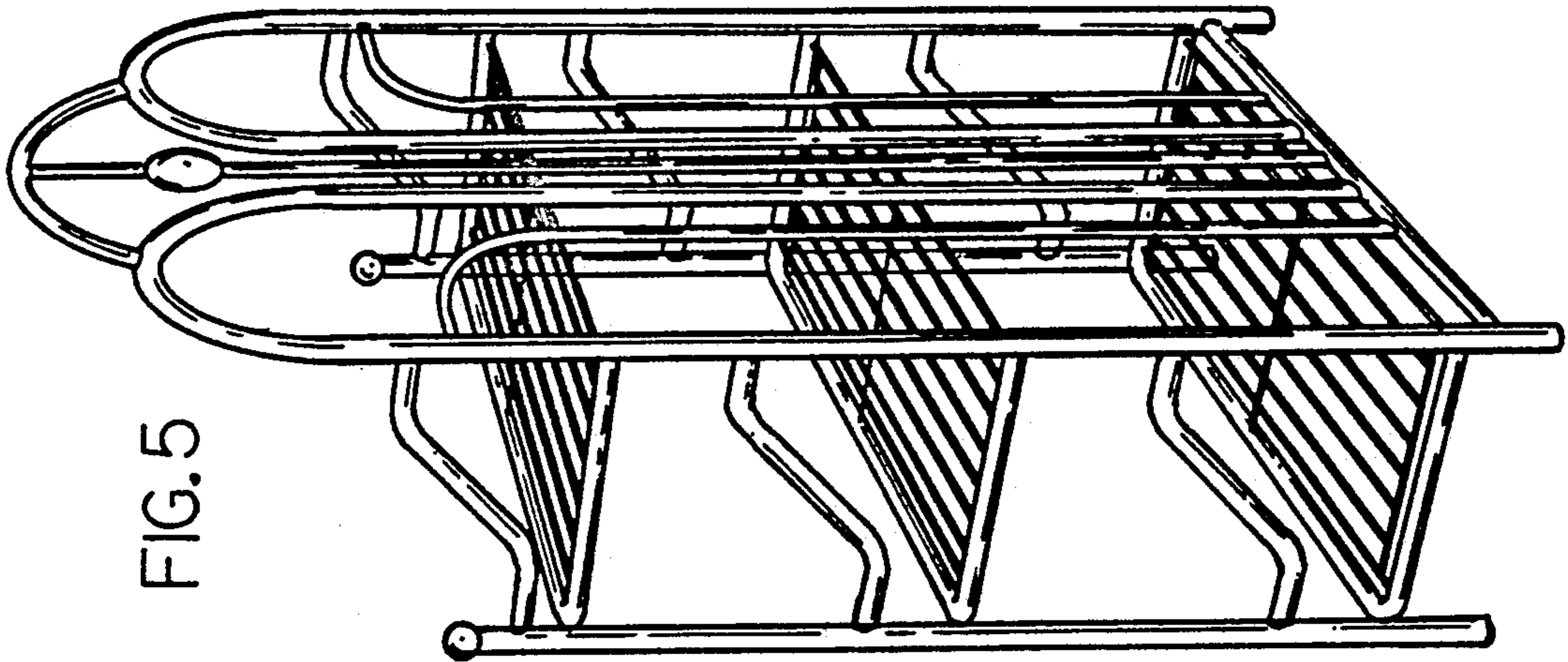

FIG. 5

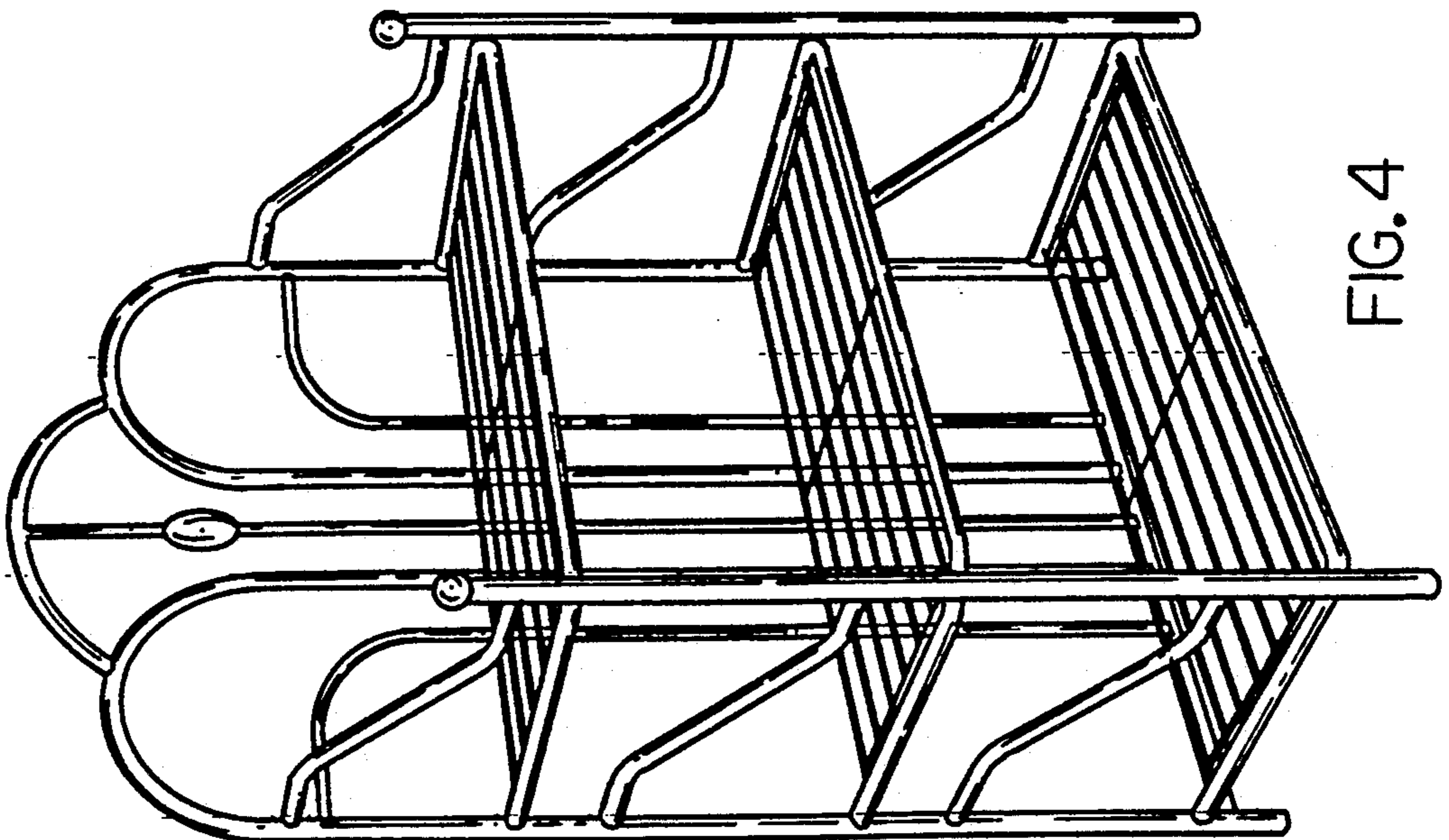

FIG. 4

FIG. 9

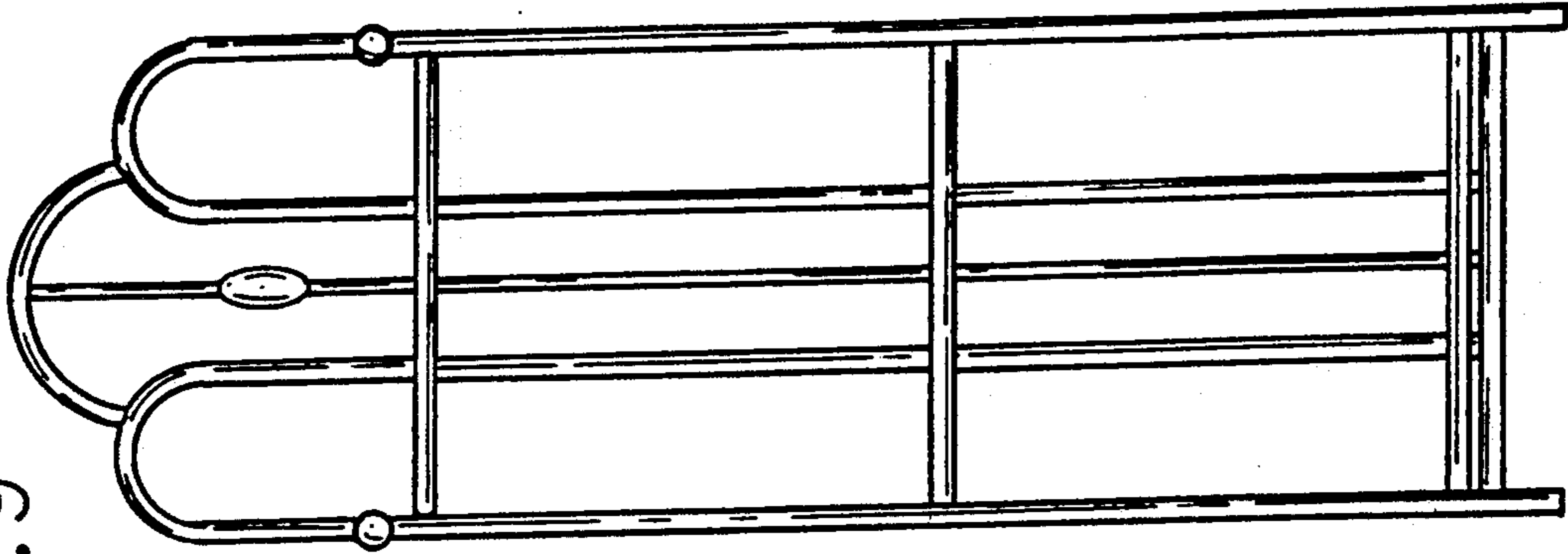

FIG. 8

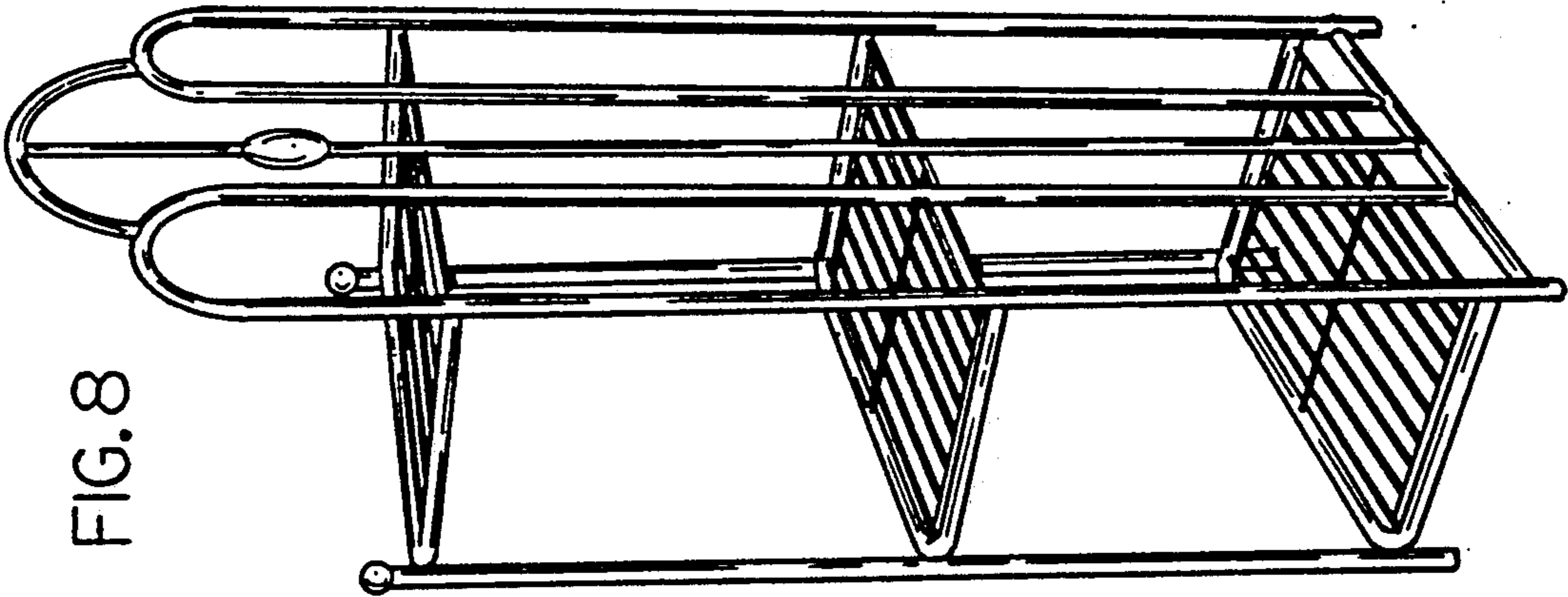

FIG. 7

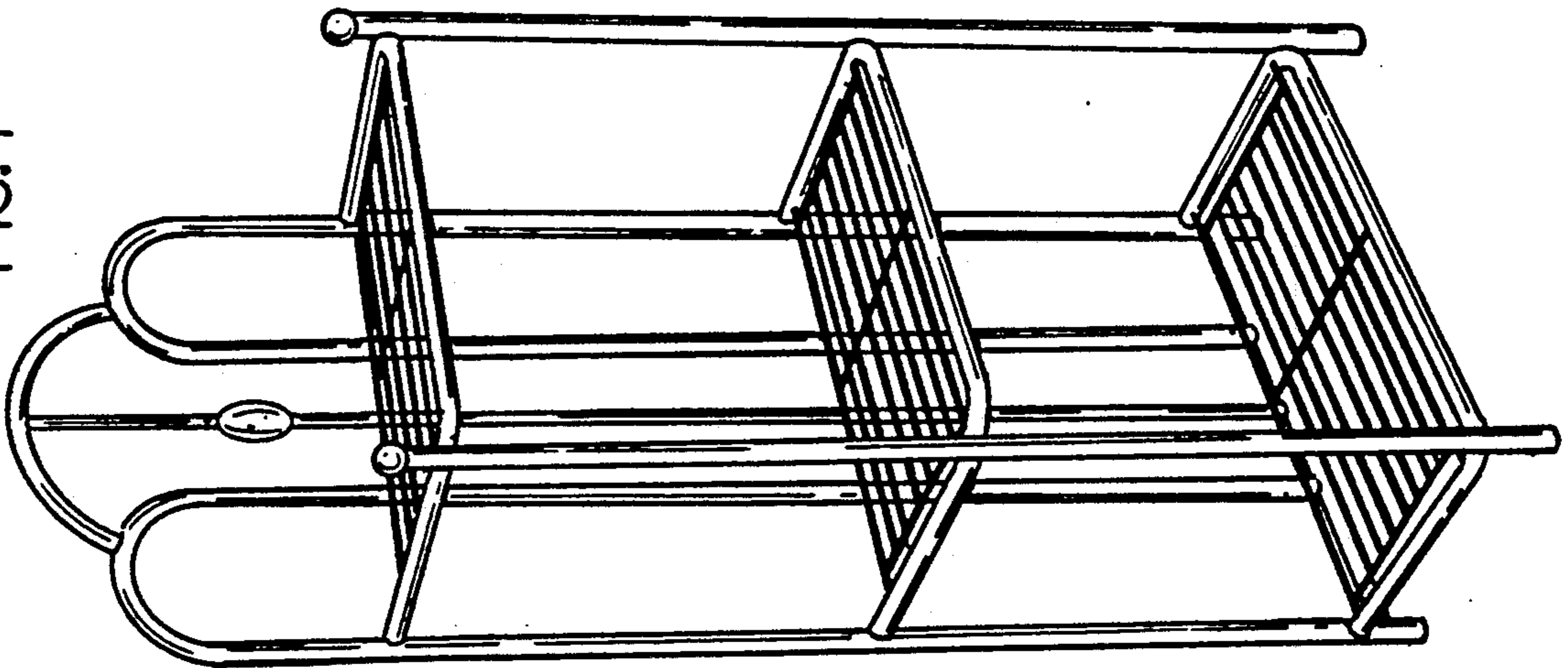

FIG. 12

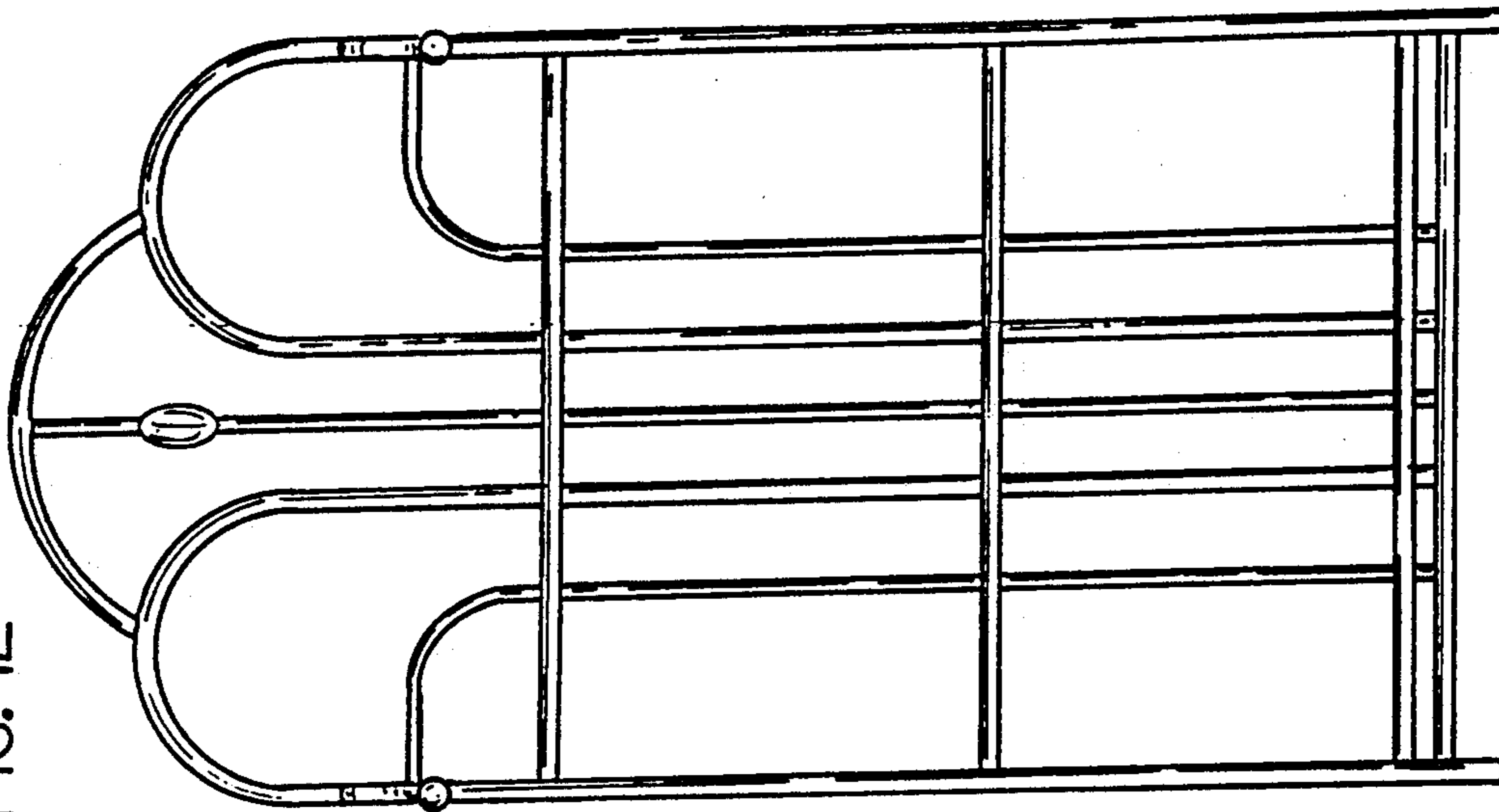

FIG. 11

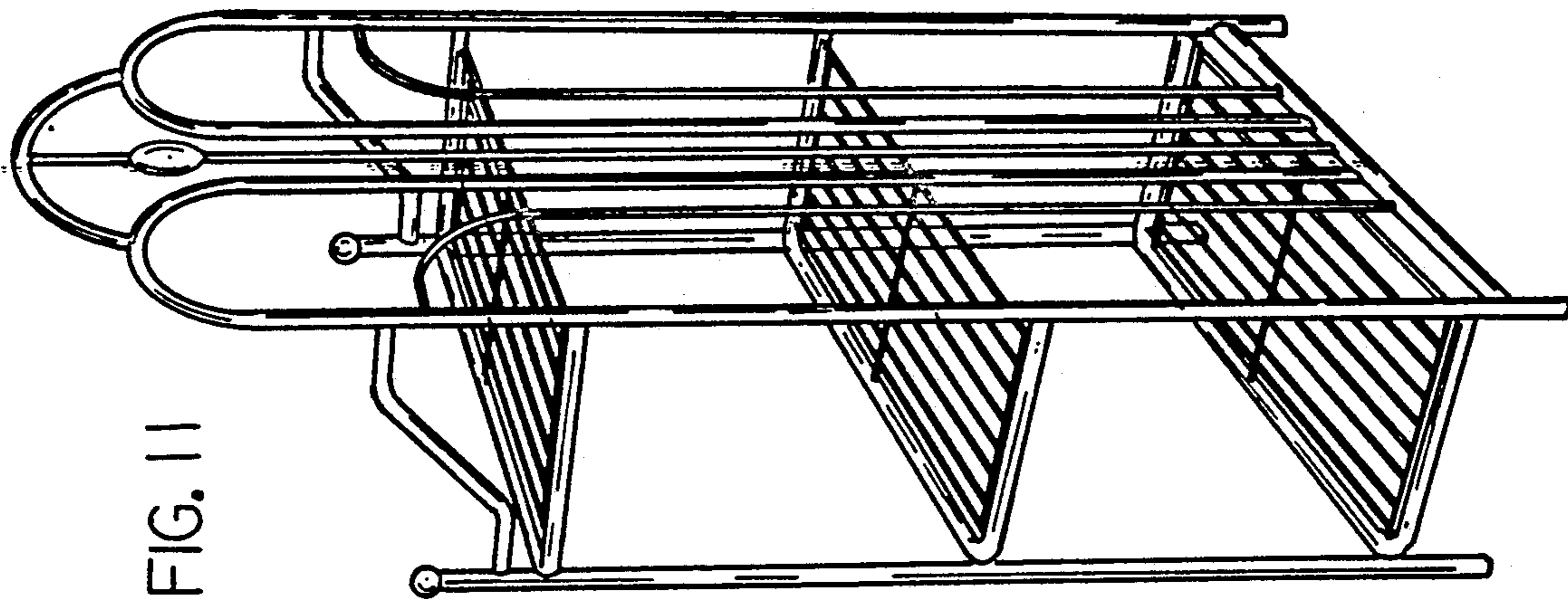

FIG. 10

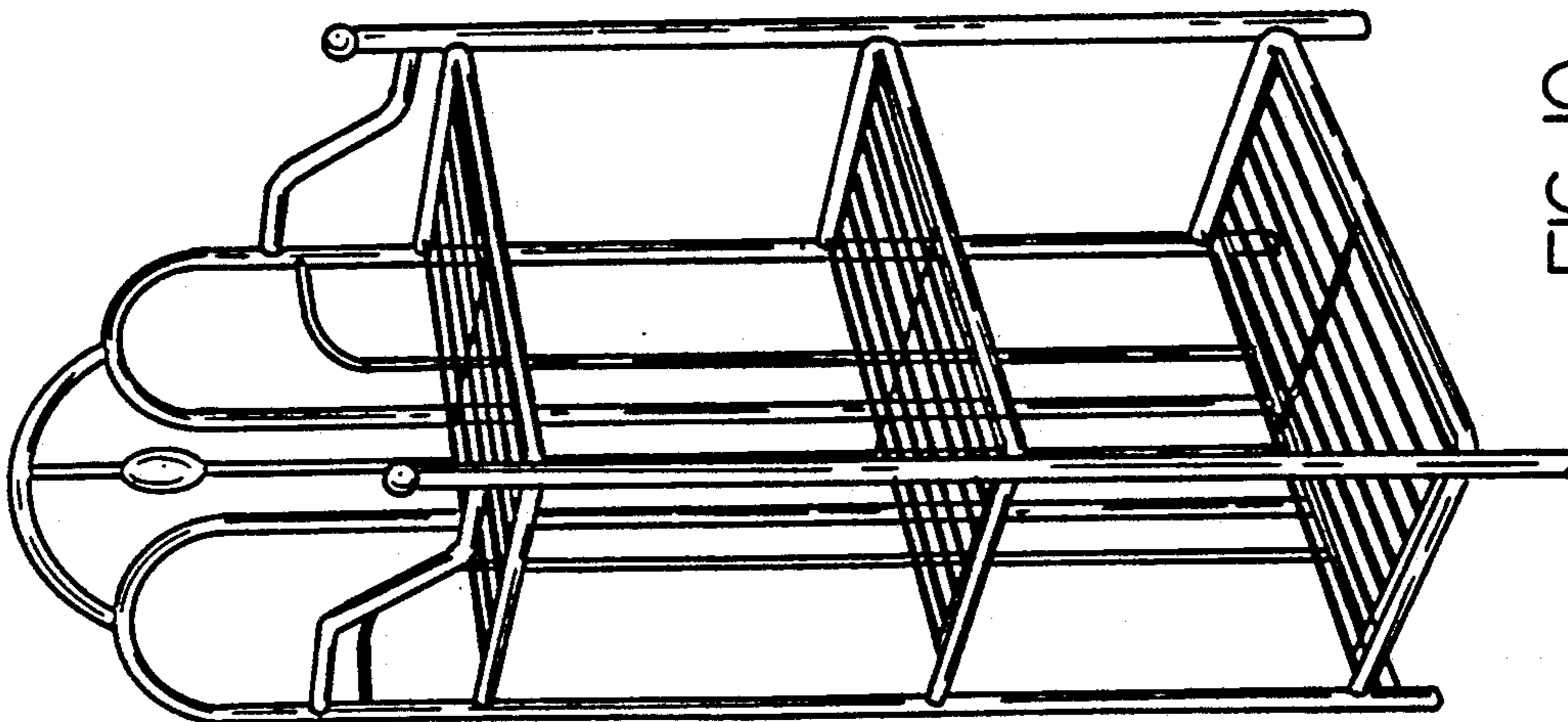

FIG. 15

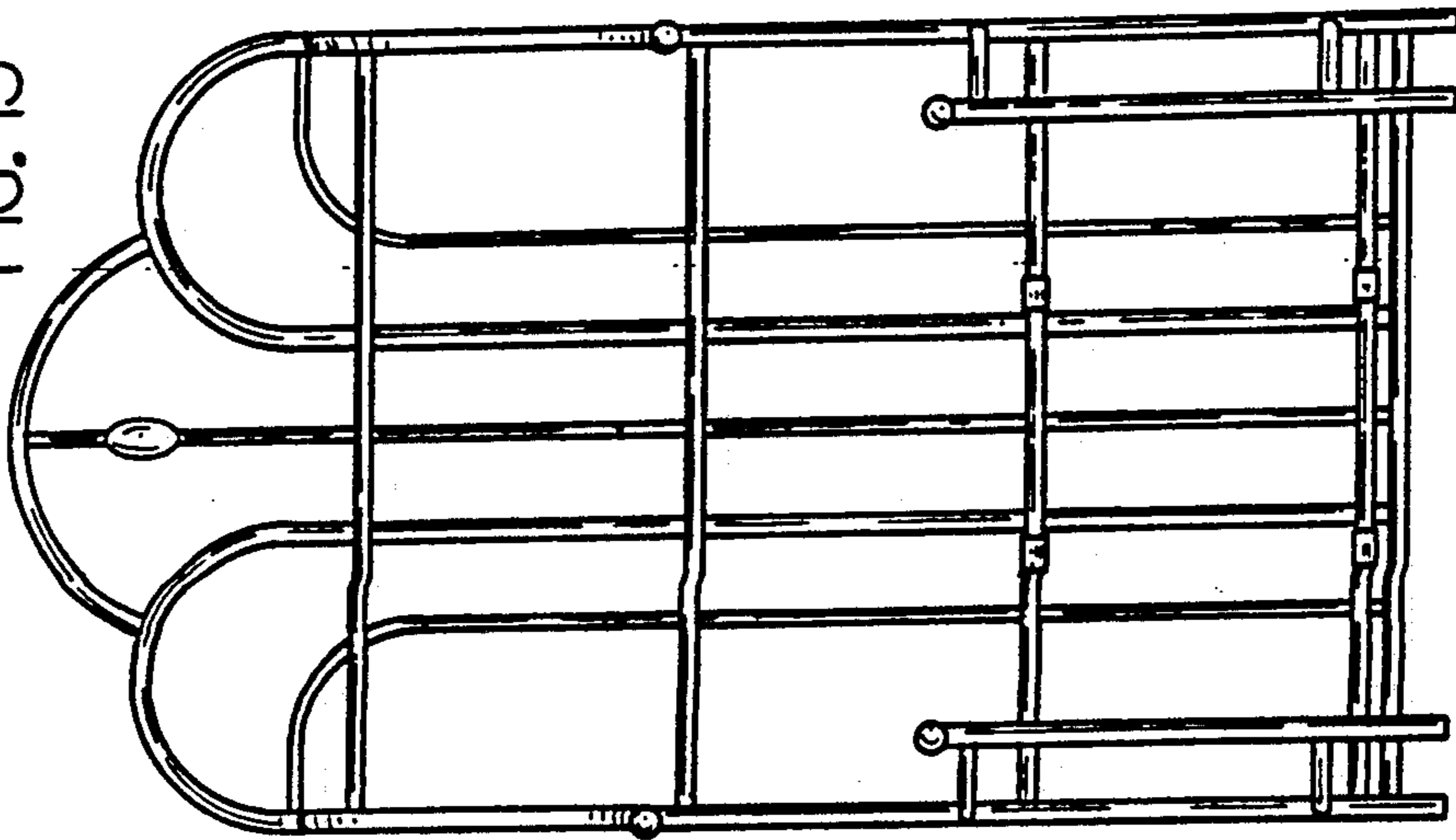

FIG. 14

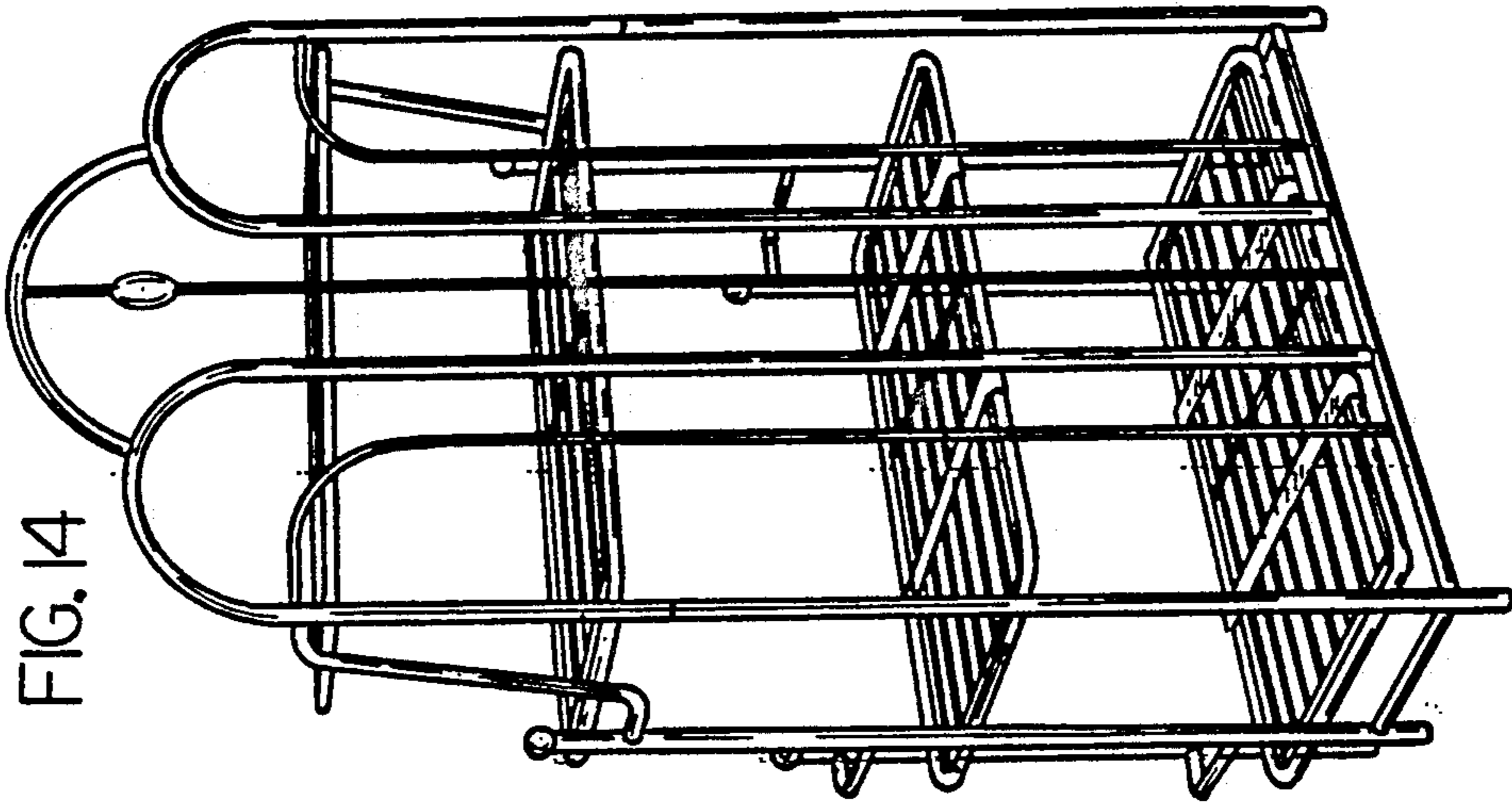

FIG. 13

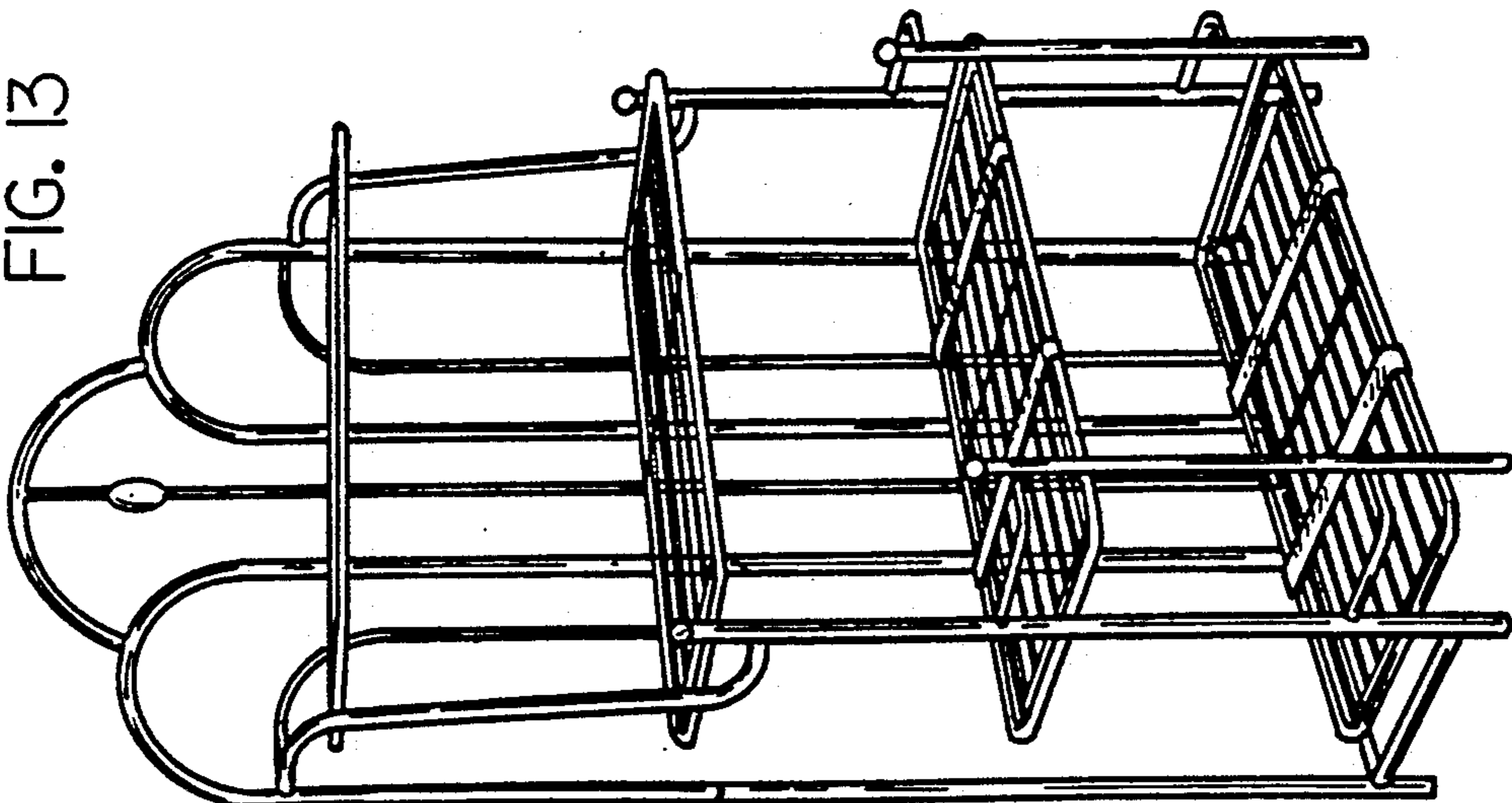

FIG. 18

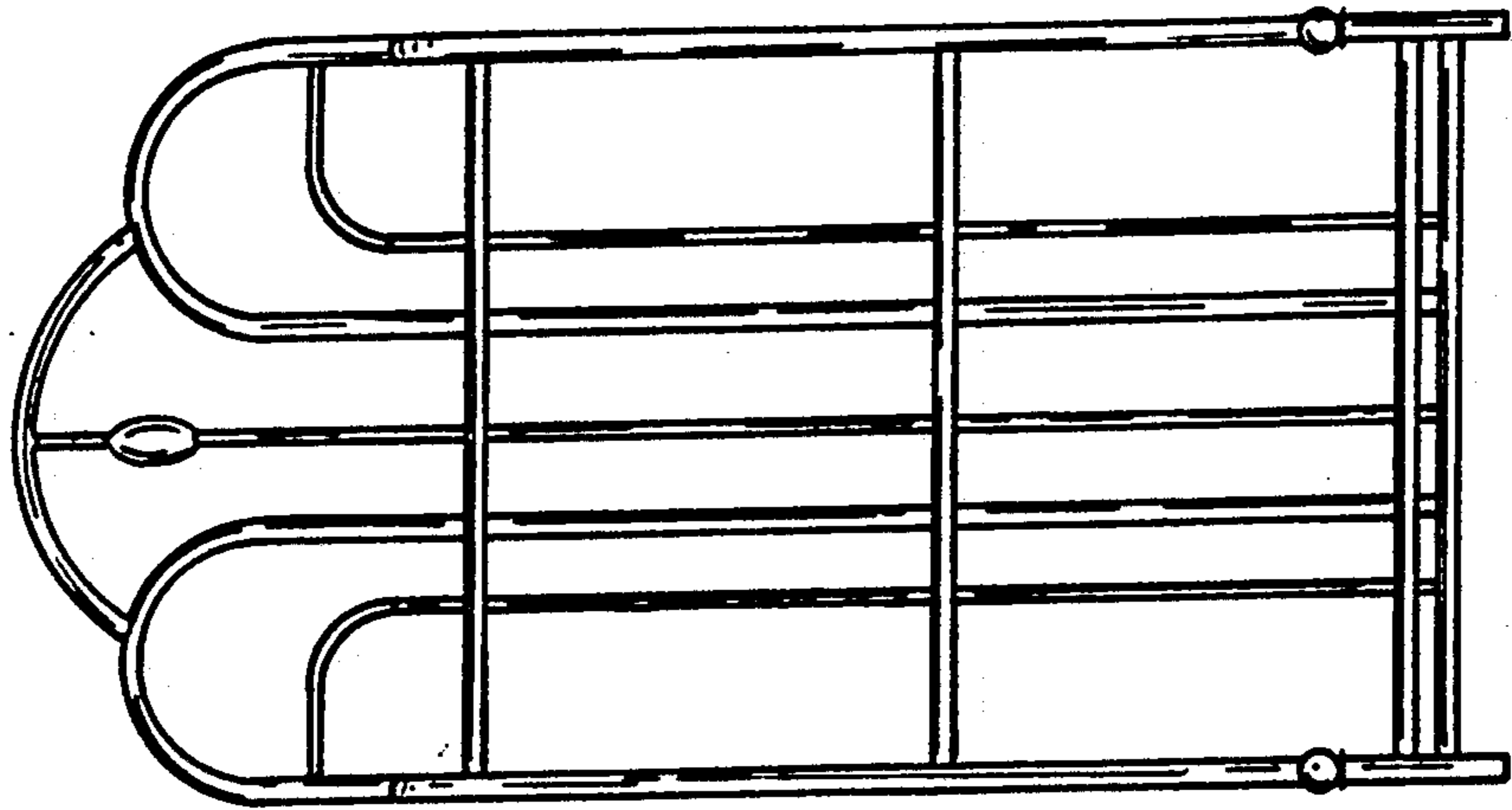

FIG. 17

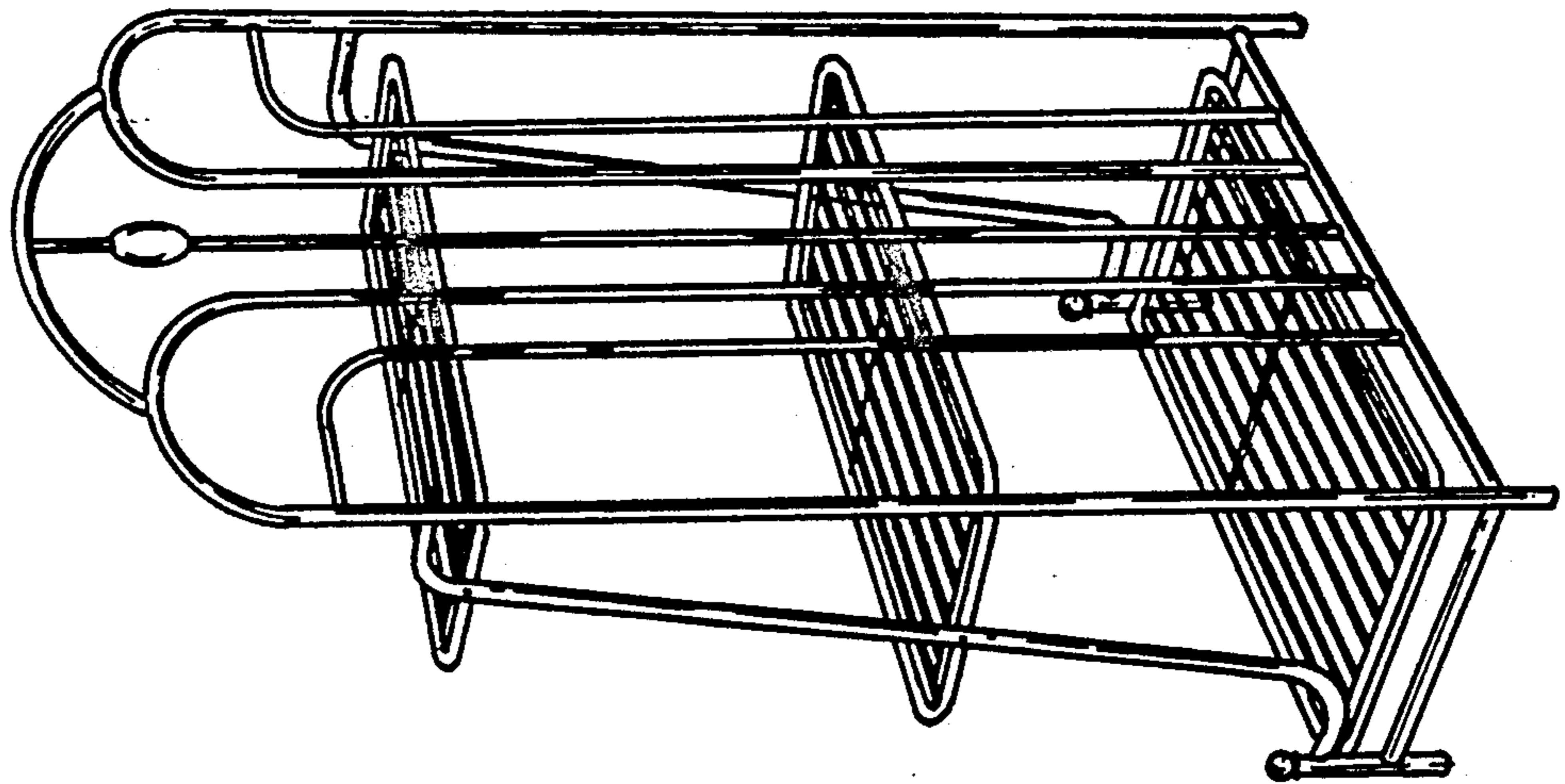
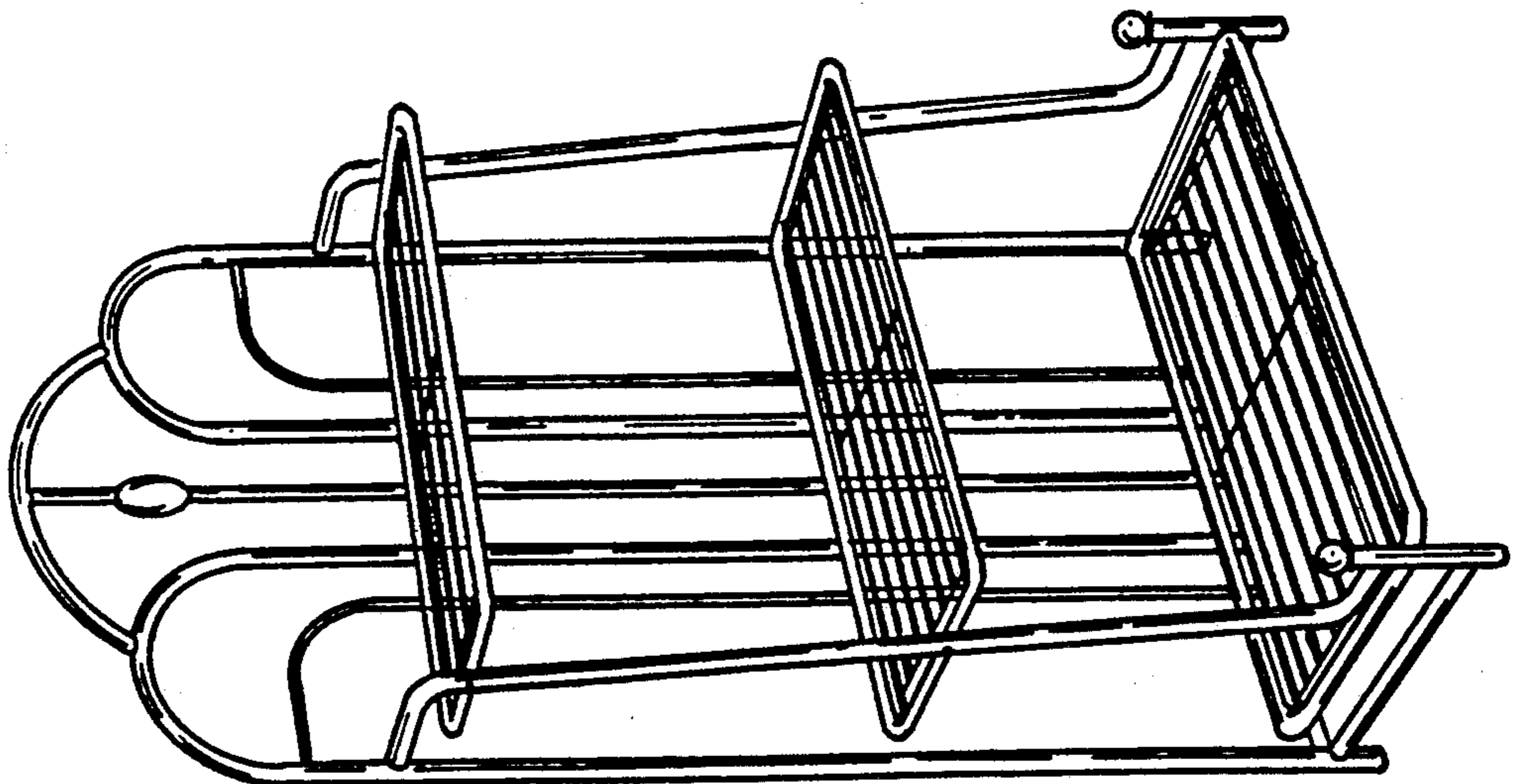

FIG. 16



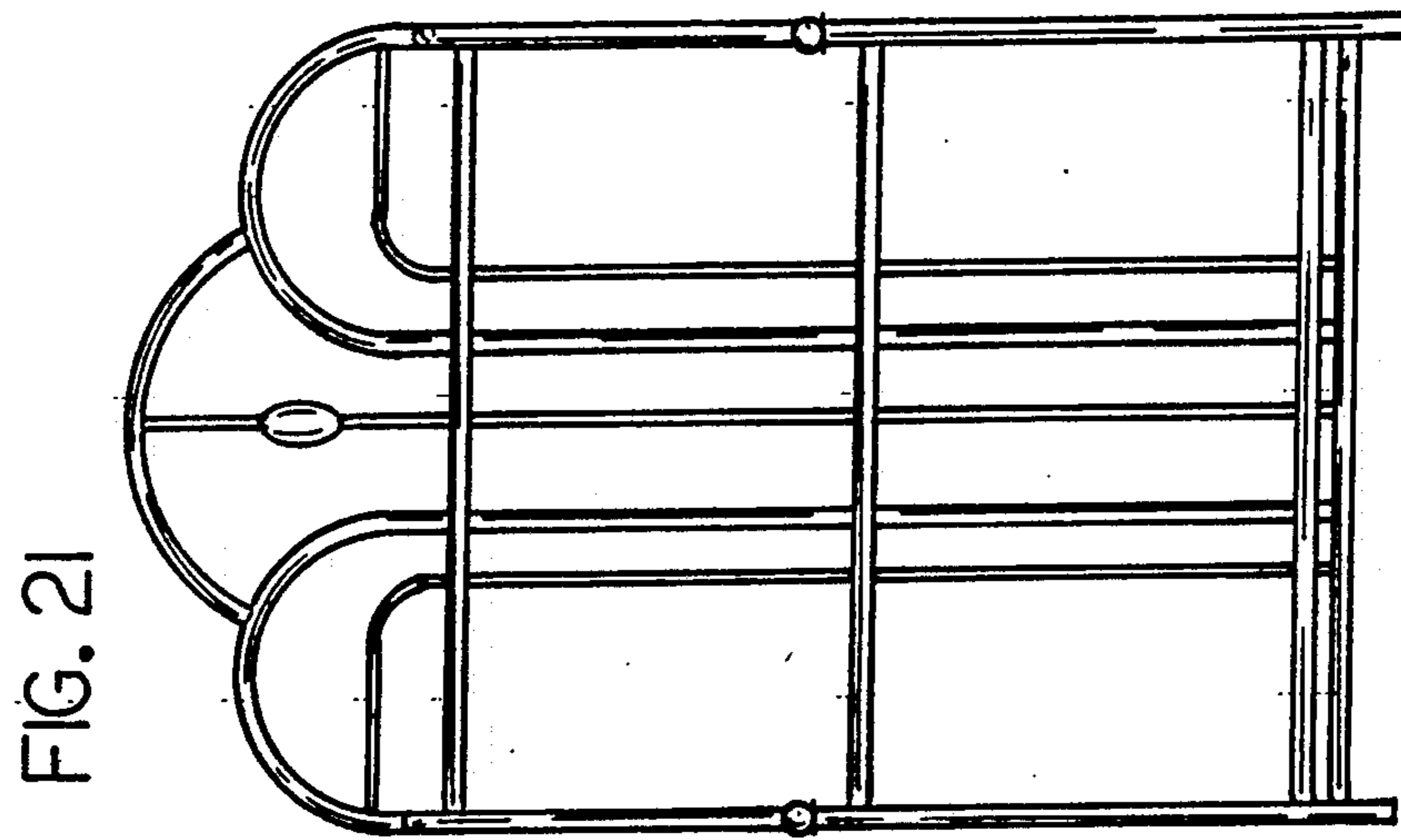

FIG. 21

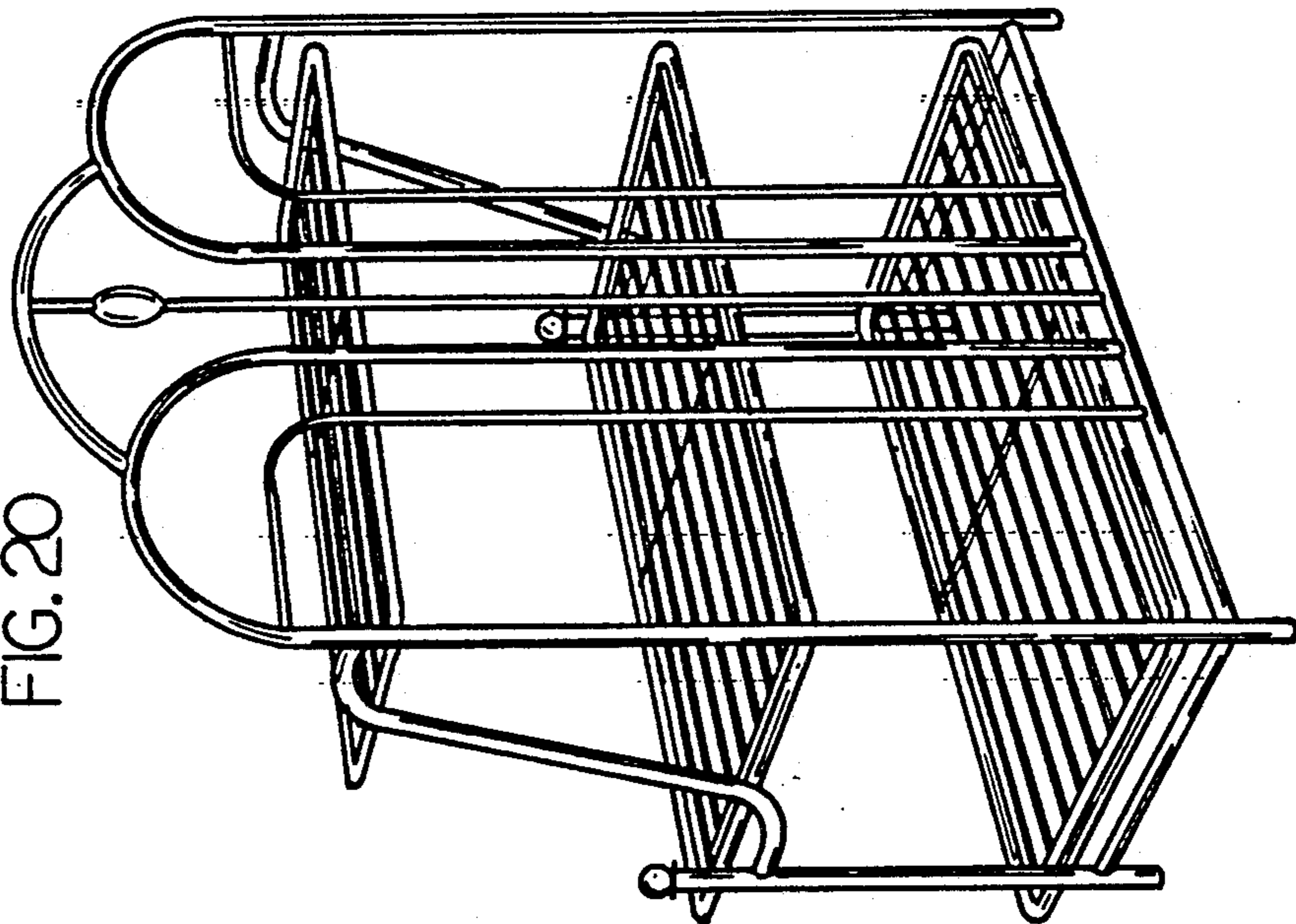

FIG. 20

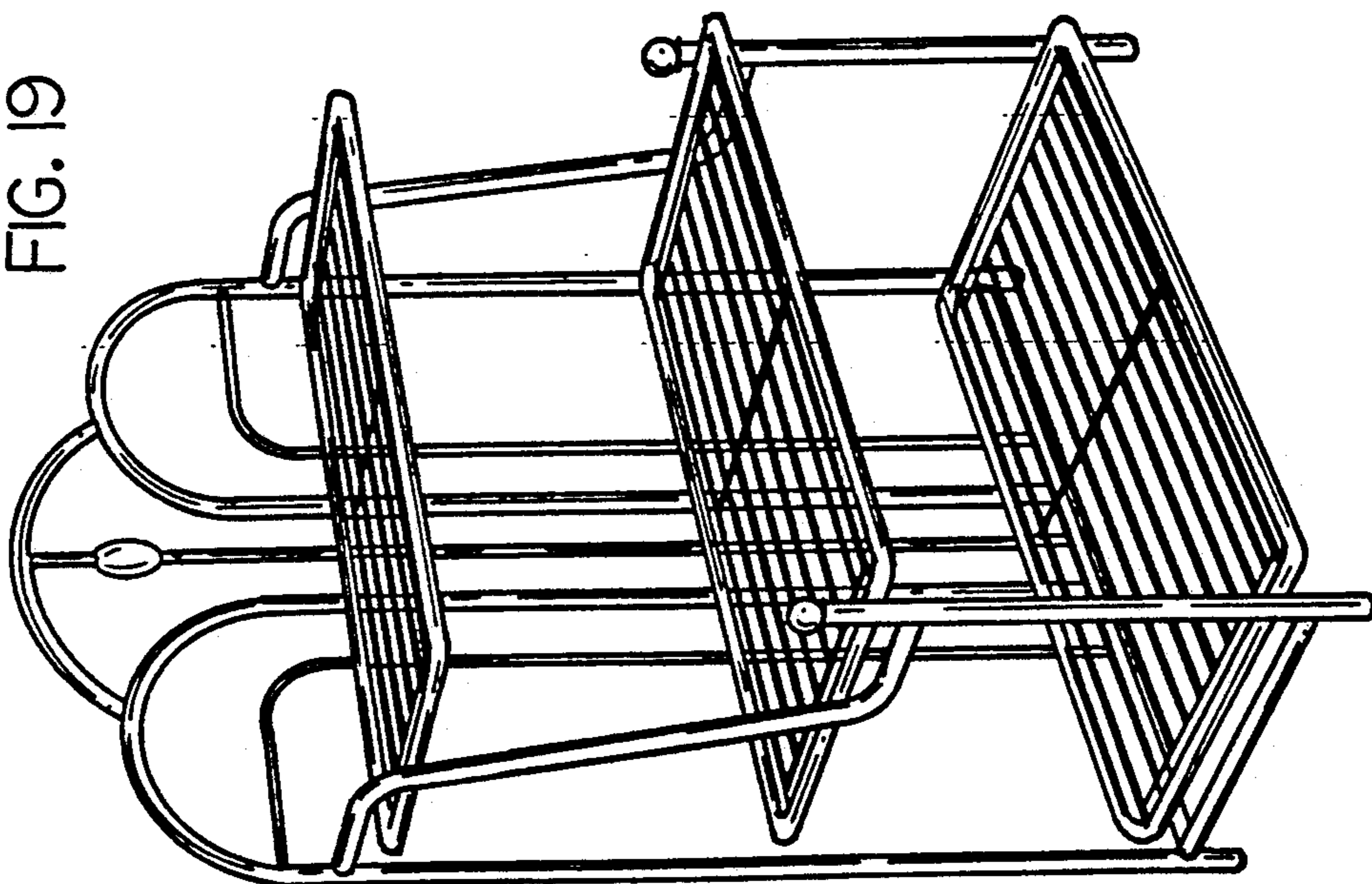

FIG. 19

