

[54] CLOCK

[75] Inventor: Kayoko Kato, Tokyo, Japan

[73] Assignee: Seikosha Co., Ltd., Japan

[**] Term: 14 Years

[21] Appl. No.: 155,630

[22] Filed: Feb. 12, 1988

[30] Foreign Application Priority Data

Sep. 3, 1987 [JP] Japan 62-36035

[52] U.S. Cl. D10/25

[58] Field of Search D10/1-39,
D10/122-132; 368/276-277, 280-282, 285

[56] References Cited

U.S. PATENT DOCUMENTS

- D. 89,168 2/1933 Carlson D10/26
- D. 204,775 5/1966 McLeod D10/26
- D. 228,791 10/1973 Stut D10/25

OTHER PUBLICATIONS

- Gift and Decorating Access* 2/1964-p. 32-Clocks.
- European Jeweler*-6/82-p. 47-Clocks at center-left.
- European Jeweler* 10/77 p. 101-Clocks.
- Home Furn. Daily* May 7-13, 1986 p. 183 Clock at center-left.
- Housewares* Jan. 1-7, 1980 p. 80 Clock at center-right.
- Primary Examiner*-Nelson C. Holtje
- Attorney, Agent, or Firm*-Bruce L. Adams; Van C. Wilks

[57] CLAIM

The ornamental design for a clock, as shown and described.

DESCRIPTION

- FIG. 1 is a front elevational view of a clock showing my new design;
- FIG. 2 is a rear elevational view thereof;
- FIG. 3 is a top plan view thereof;
- FIG. 4 is a bottom plan view thereof;
- FIG. 5 is a left side elevational view thereof;
- FIG. 6 is a right side elevational view thereof; and
- FIG. 7 is a front and top right perspective view thereof.

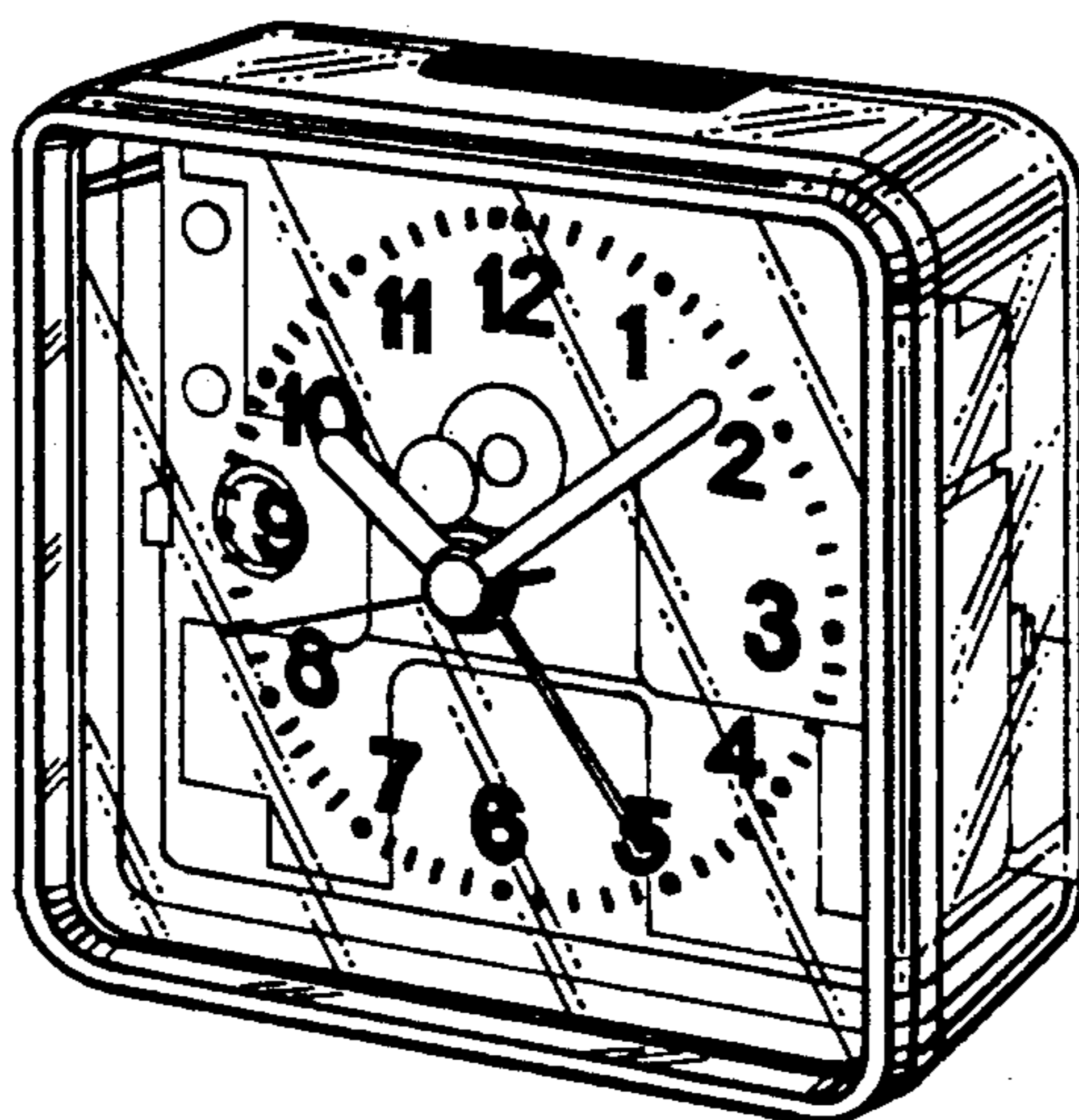

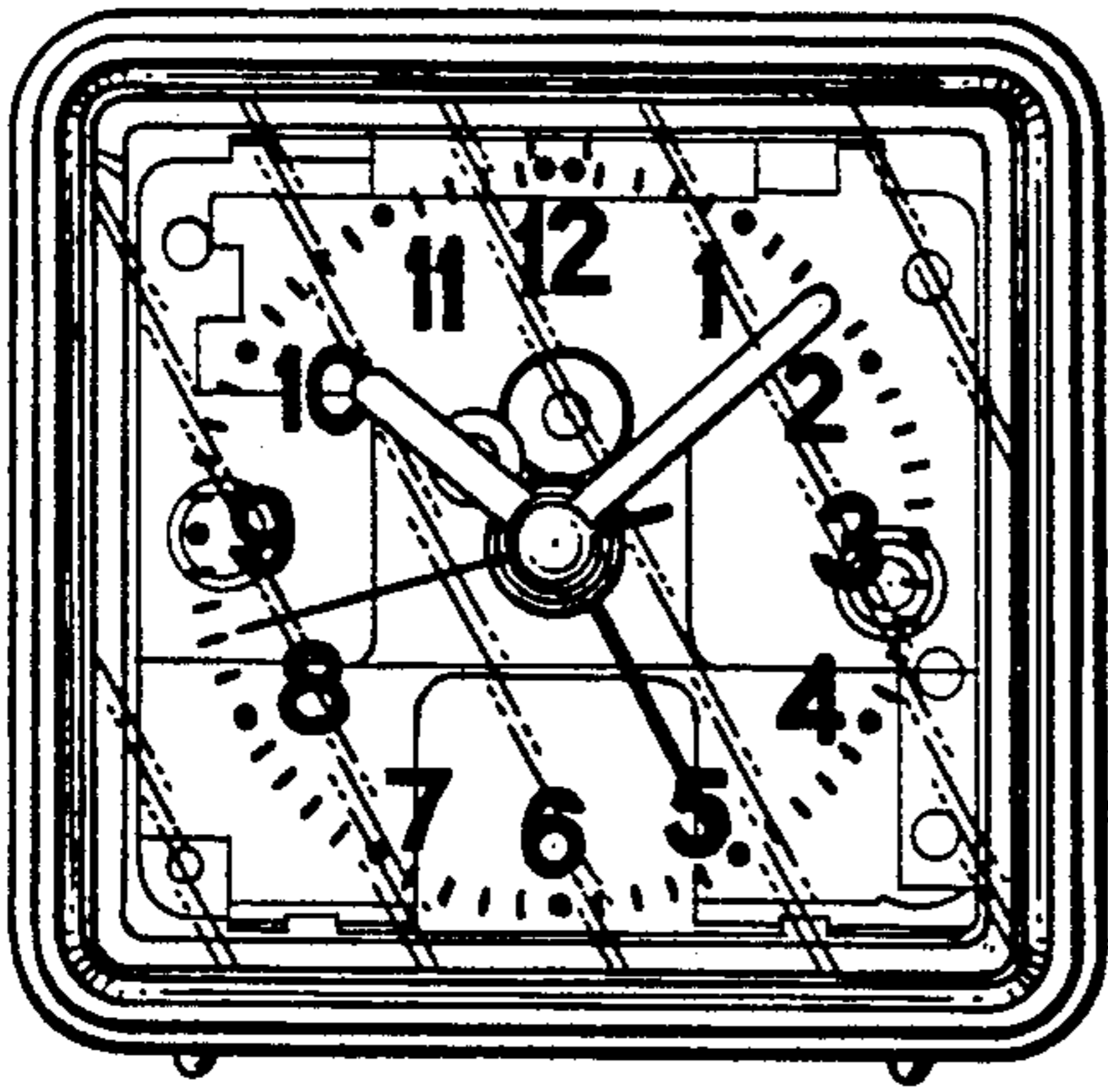

FIG. 1

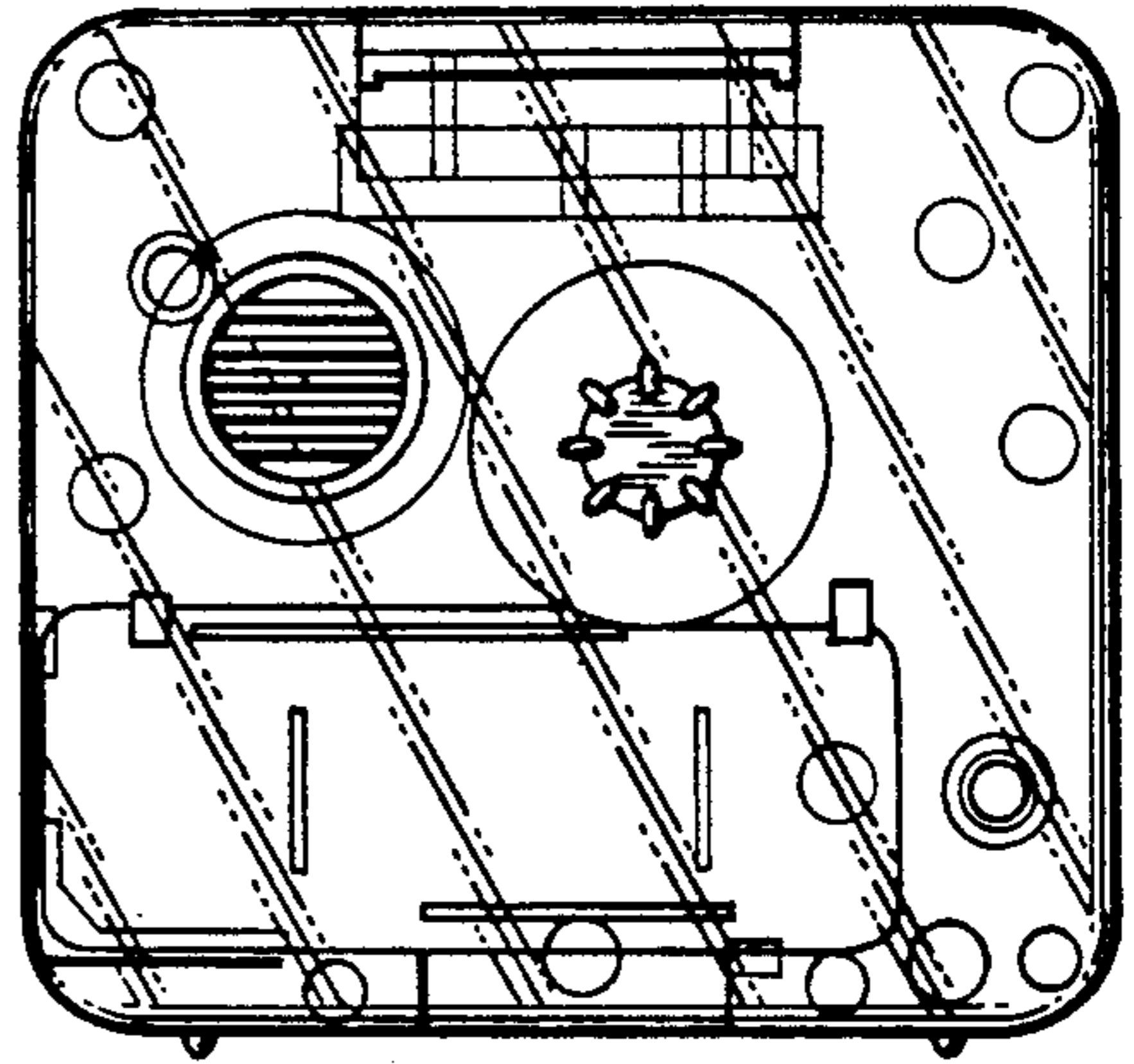

FIG. 2

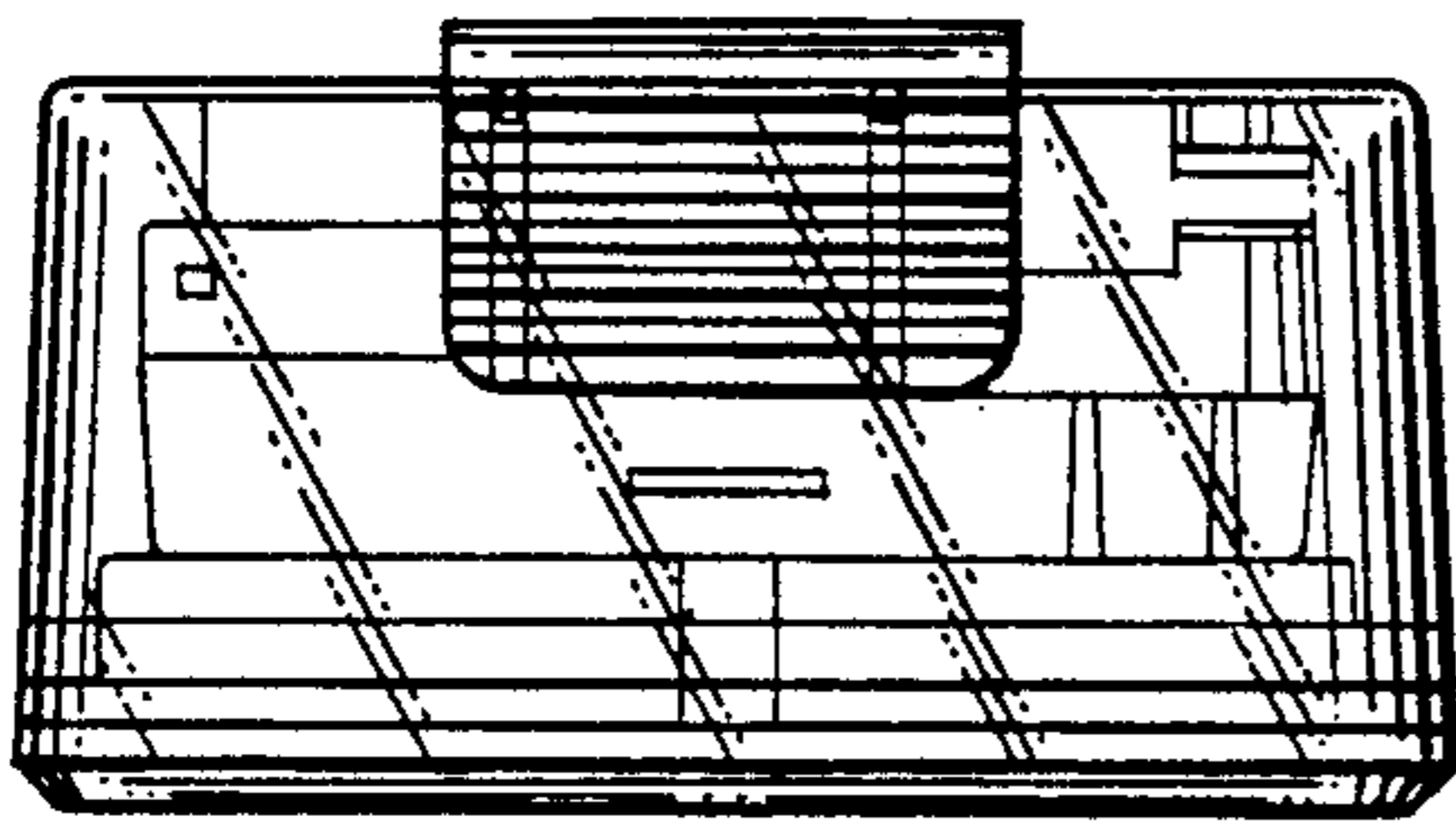

FIG. 3

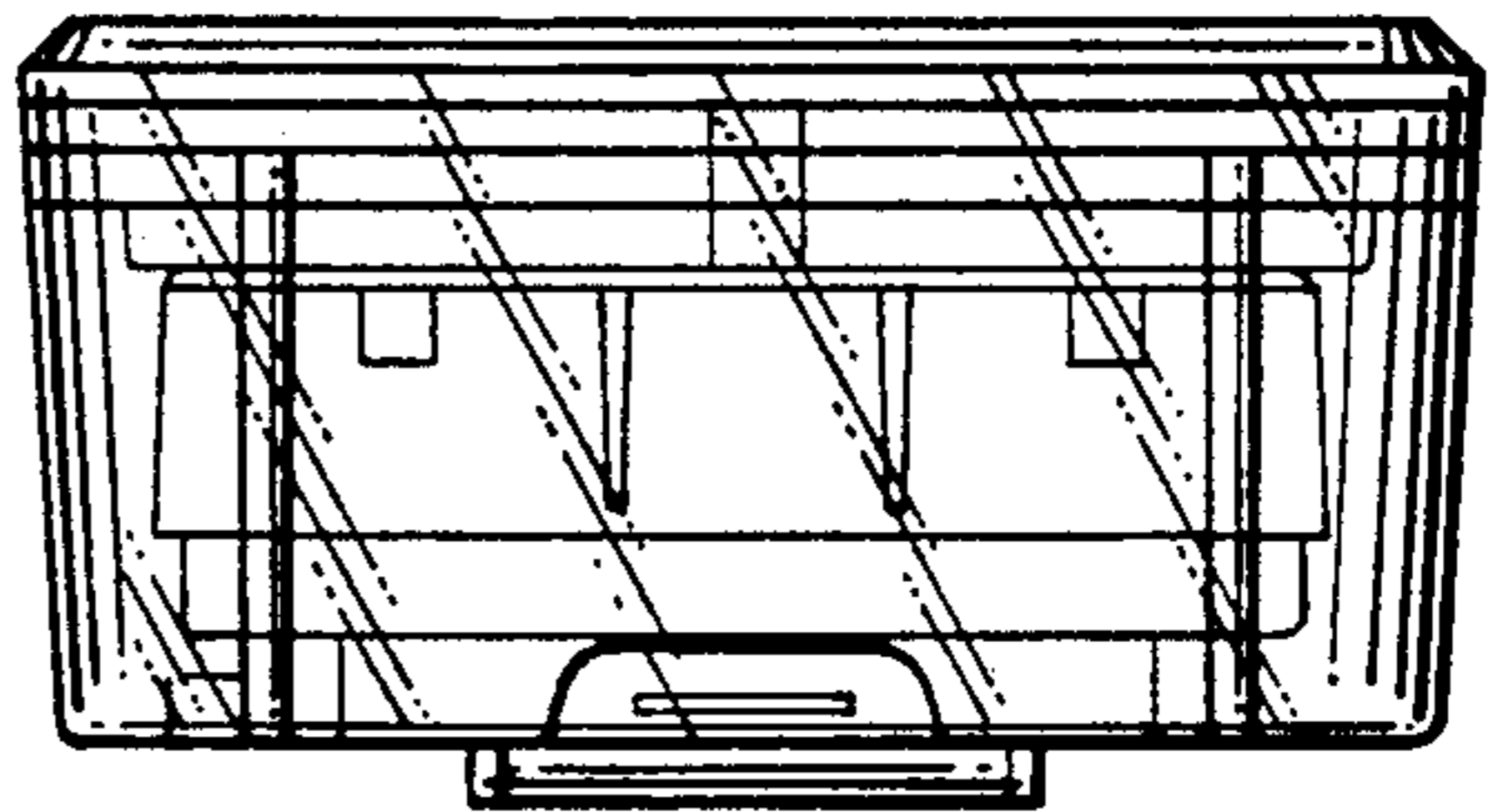

FIG. 4

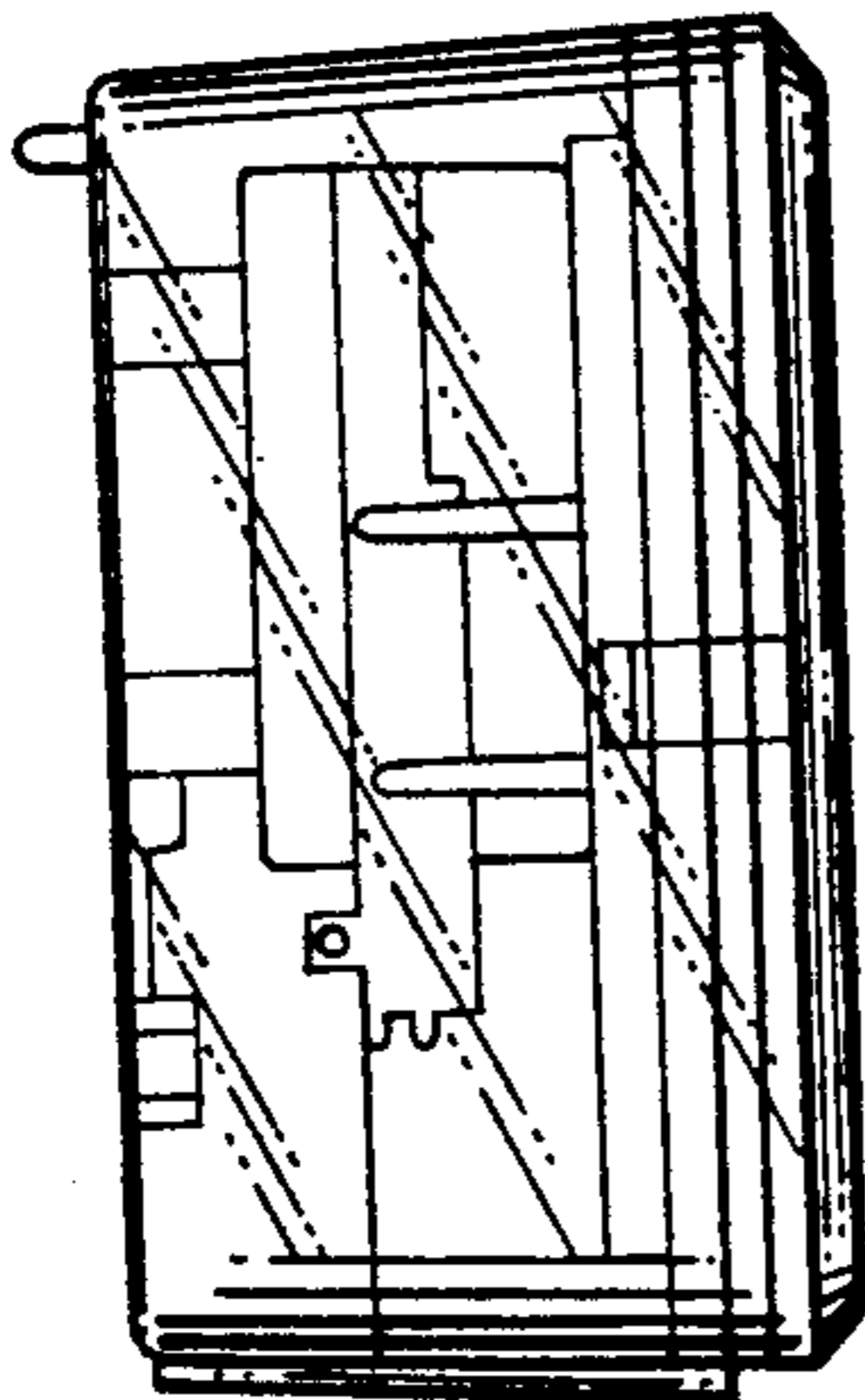

FIG. 5

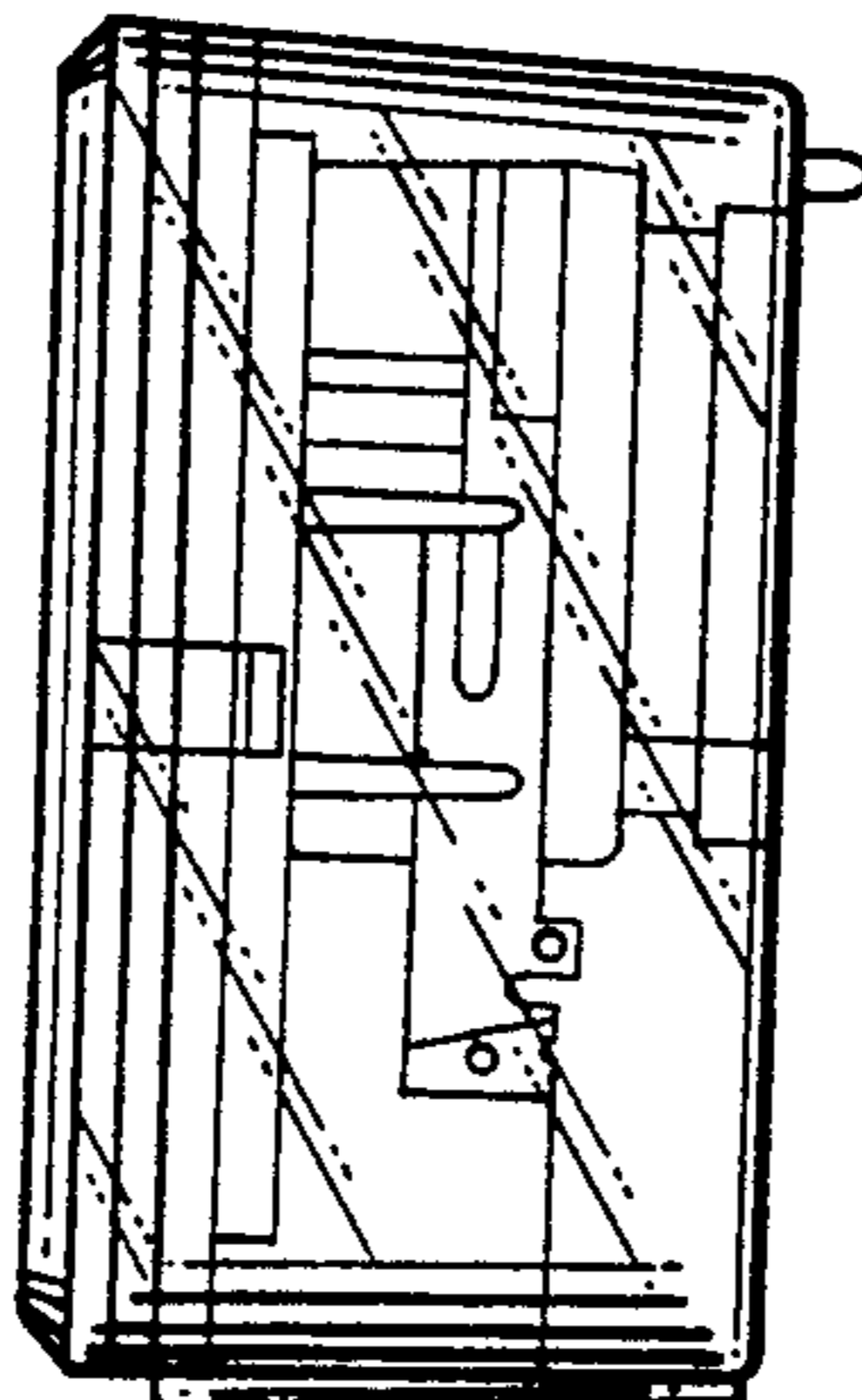

FIG. 6

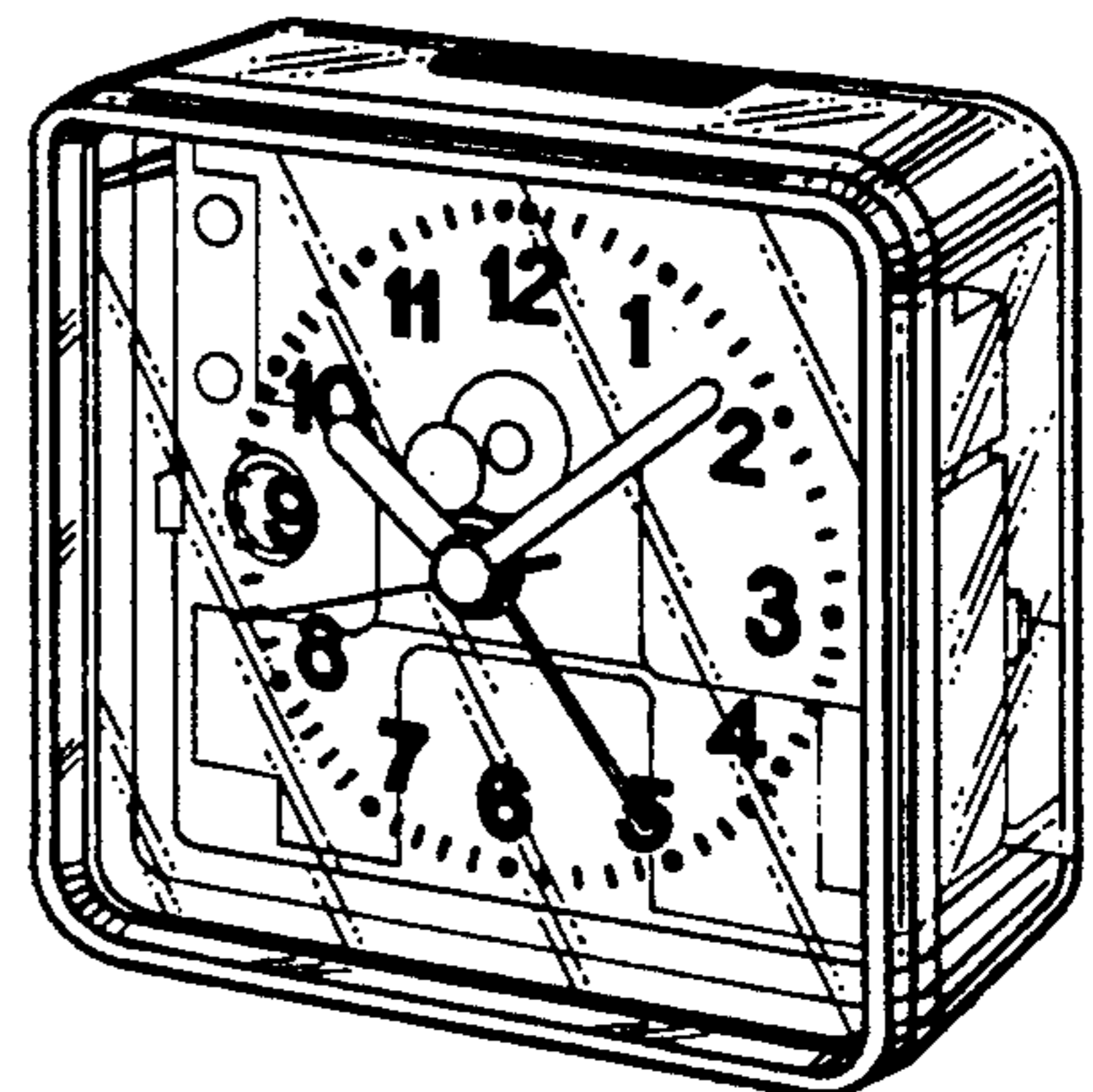

FIG. 7