

[54] **TOASTER**

[75] **Inventor: Lutz Gebhardt, Darmstadt, Fed. Rep. of Germany**

[73] **Assignee: Rowenta-Werke GmbH, Offenbach am Main, Fed. Rep. of Germany**

[**] **Term: 14 Years**

[21] **Appl. No.: 189,741**

[22] **Filed: May 3, 1988**

[30] **Foreign Application Priority Data**

Nov. 4, 1987 [DE] Fed. Rep. of Germany ... 5MR10799
[52] **U.S. Cl. D7/330**
[58] **Field of Search 99/388, 389, 391, 385, 99/327, 331; D7/328, 330, 329, 323, 331**

[56] **References Cited**

U.S. PATENT DOCUMENTS

D. 127,814 6/1941 Reinecke et al. D7/330
D. 220,809 5/1971 Krammes D7/330
2,339,183 1/1944 Myers 99/327
2,764,081 9/1956 Glasser 99/391

Primary Examiner—Winifred E. Herrmann
Attorney, Agent, or Firm—Toren, McGeady & Associates

[57] **CLAIM**

The ornamental design for a toaster, as shown.

DESCRIPTION

FIG. 1 is a front perspective view of a toaster showing my new design;
FIG. 2 is a rear perspective thereof;
FIG. 3 is a right side elevational view thereof;
FIG. 4 is a left side elevational view thereof;
FIG. 5 is a front elevational view thereof;
FIG. 6 is a rear perspective view thereof;
FIG. 7 is a top plan view thereof; and
FIG. 8 is a bottom plan view thereof.

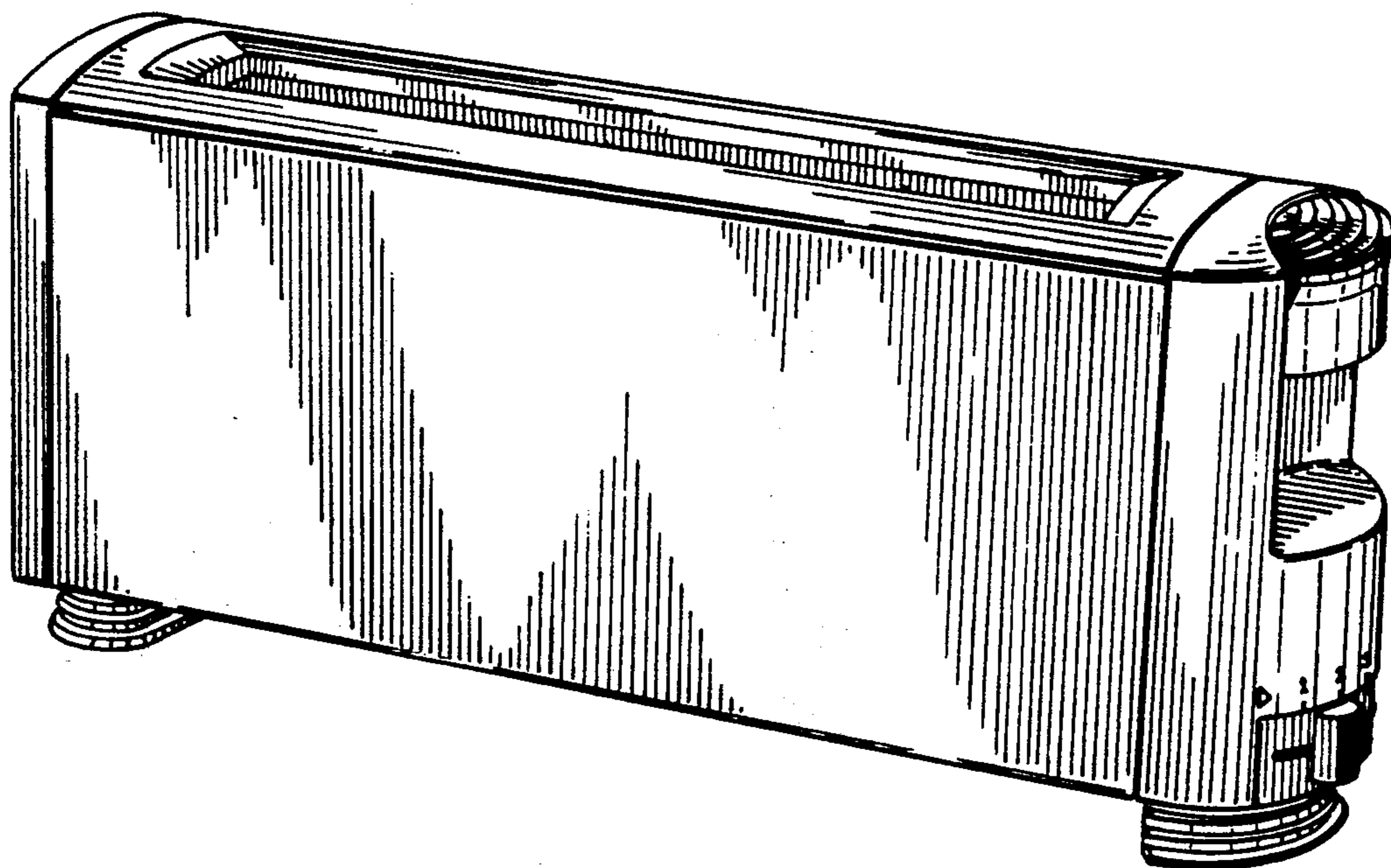

FIG.-1

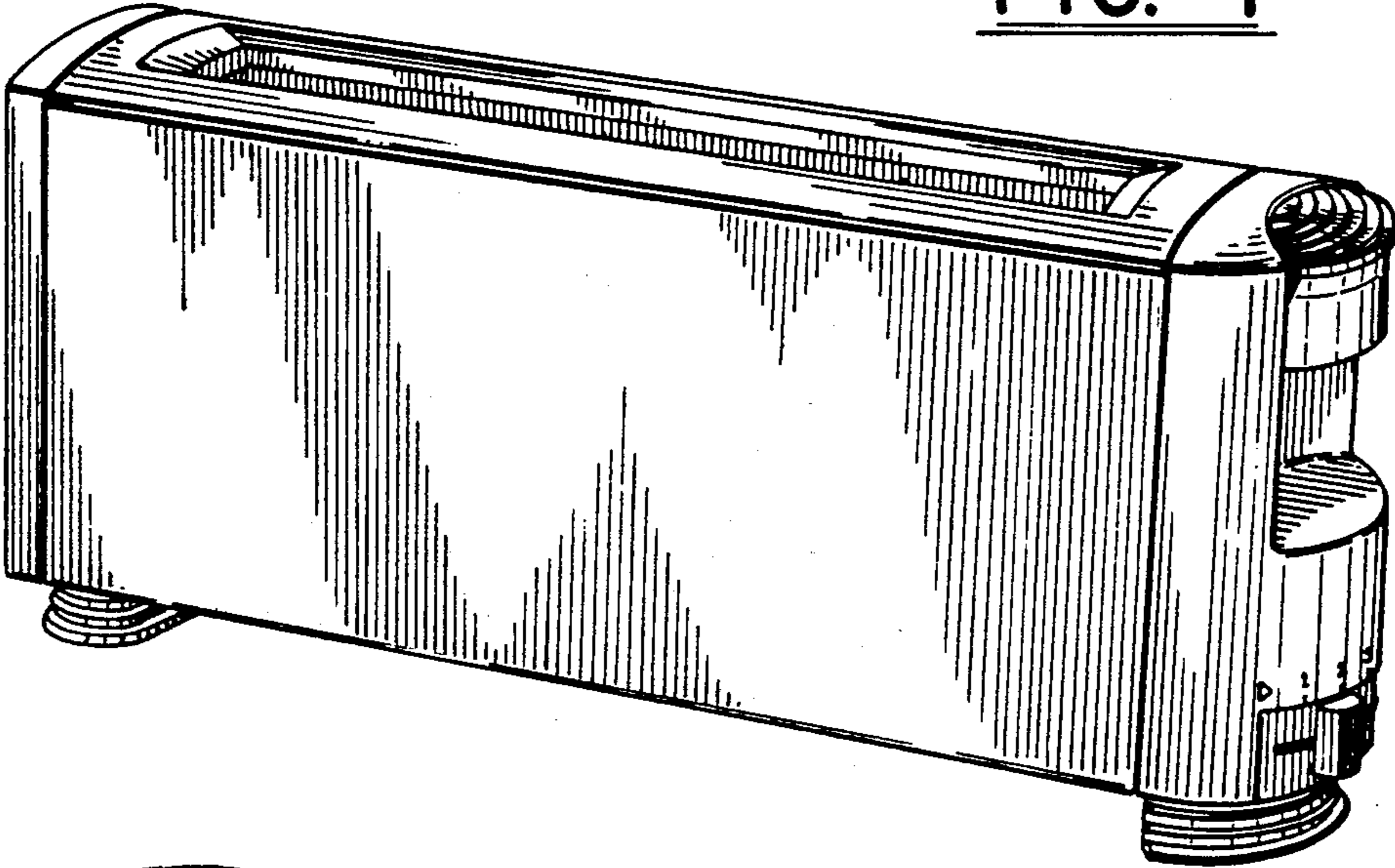

FIG.-2

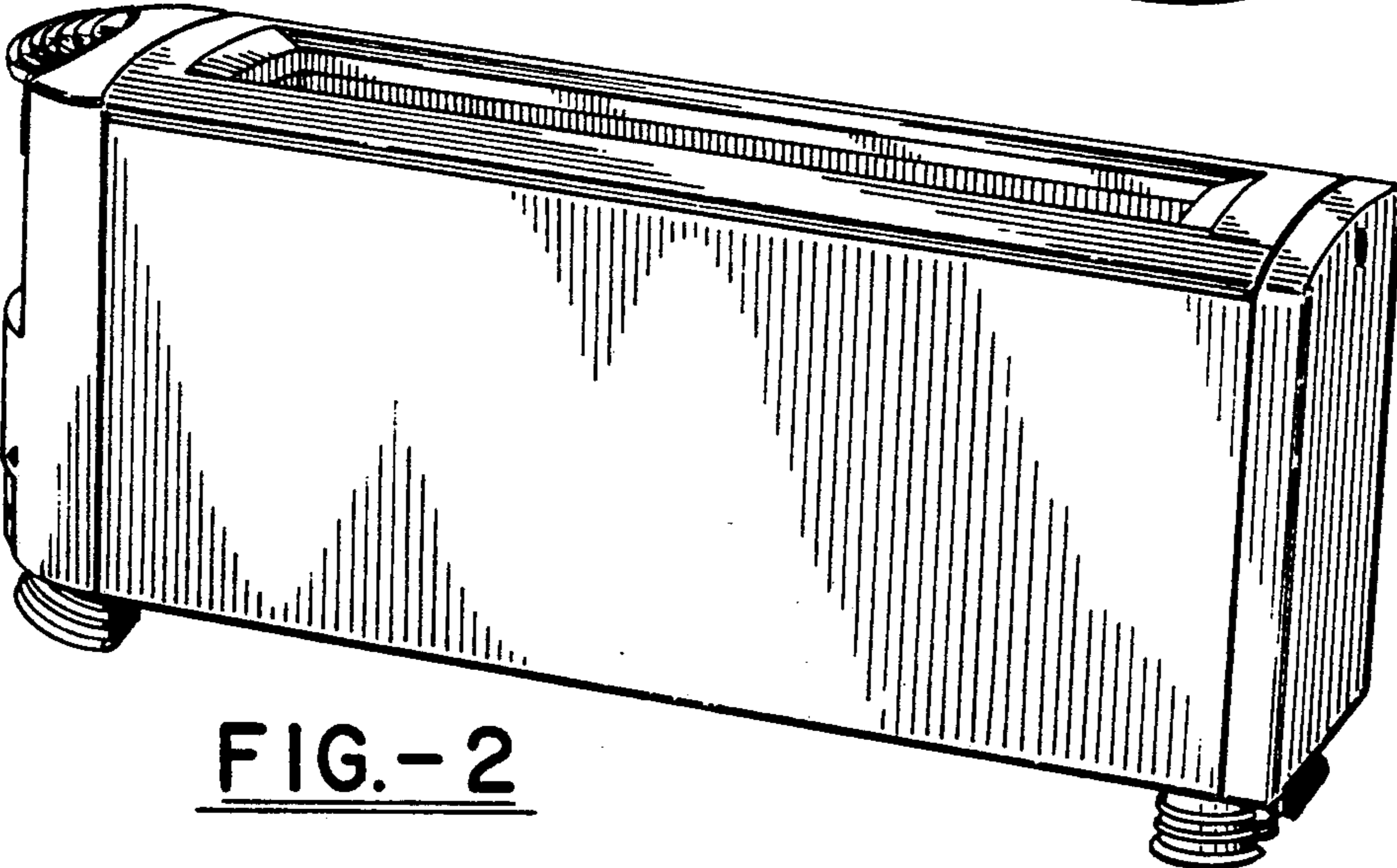

FIG.-3

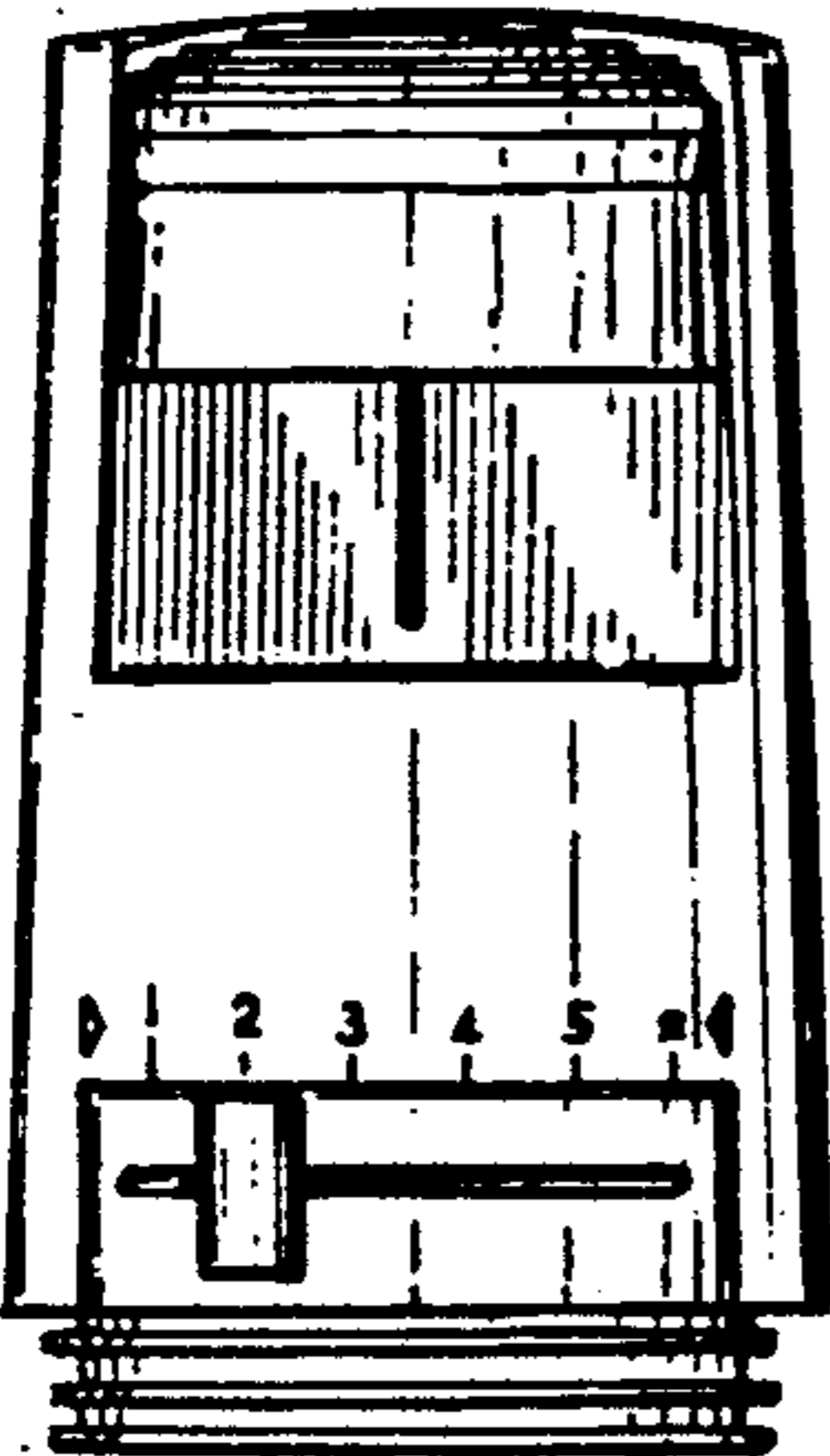
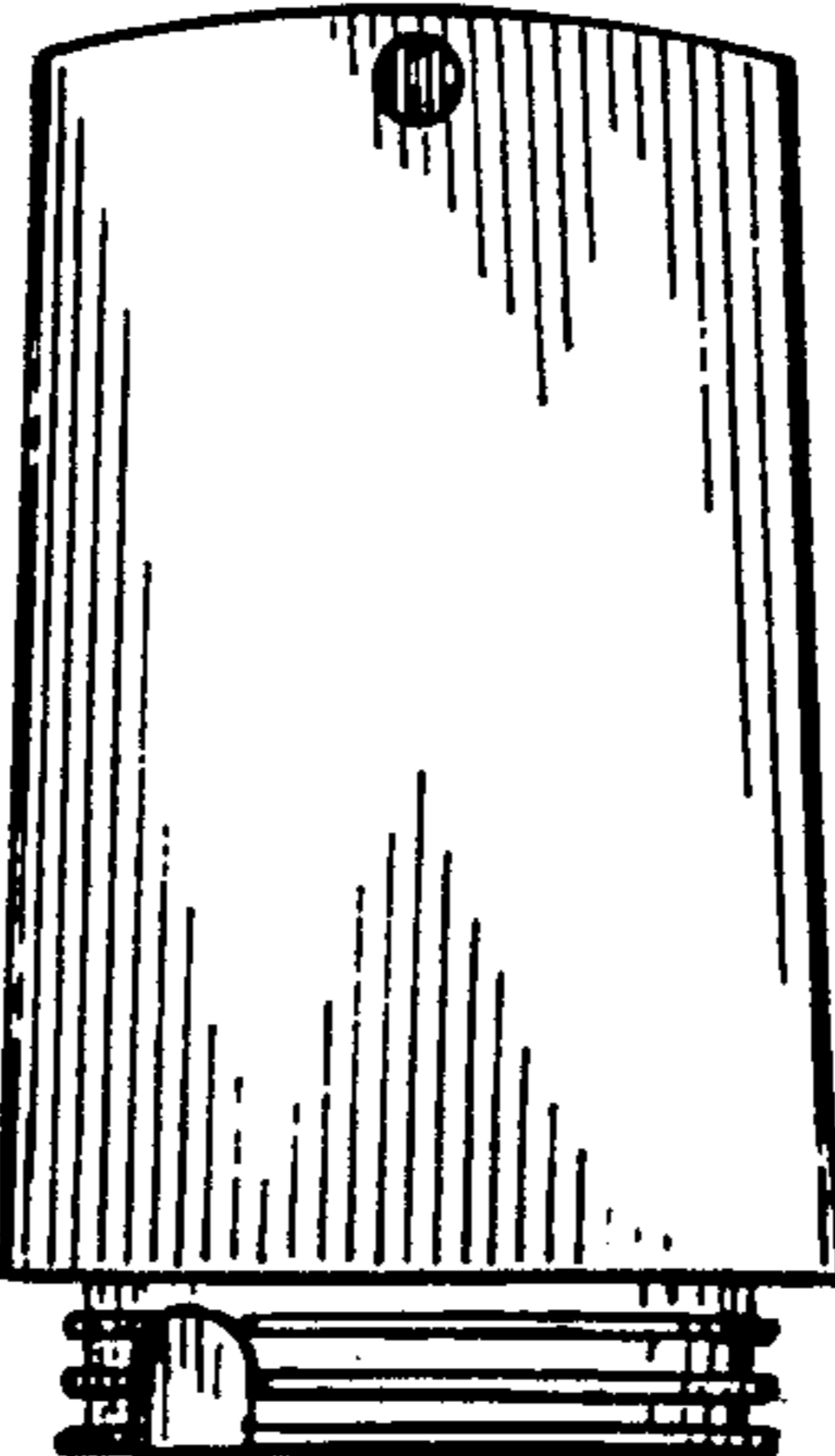

FIG.-4



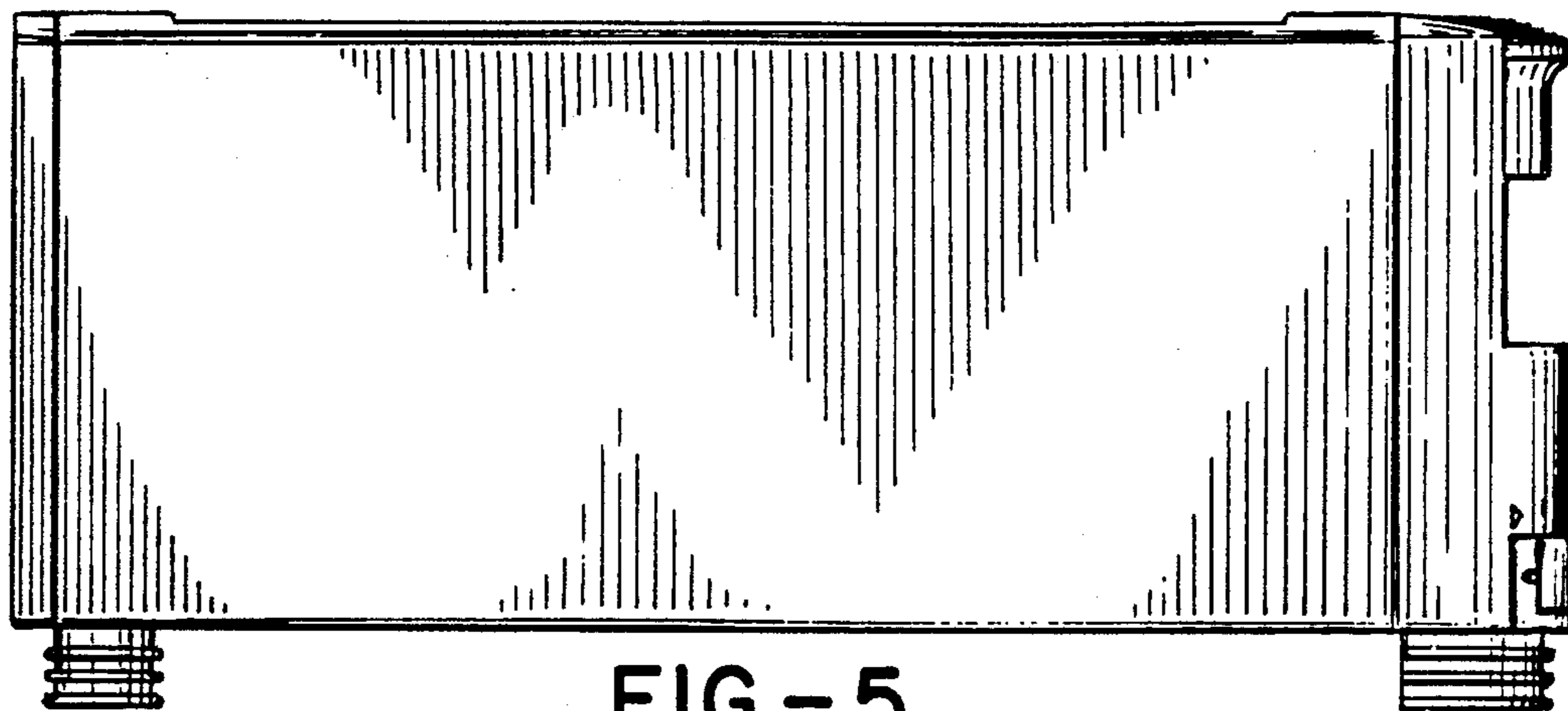

FIG.-5

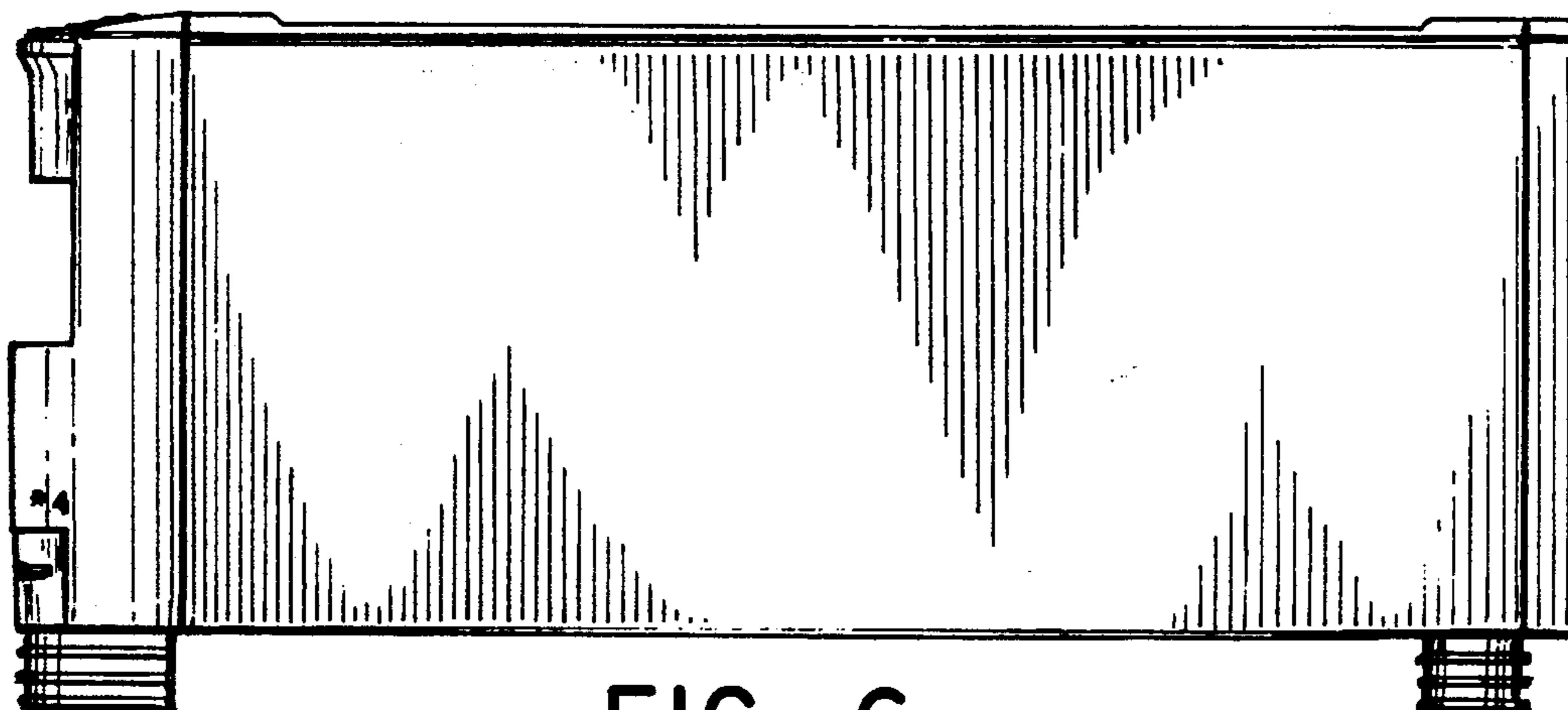

FIG.-6



FIG.-7

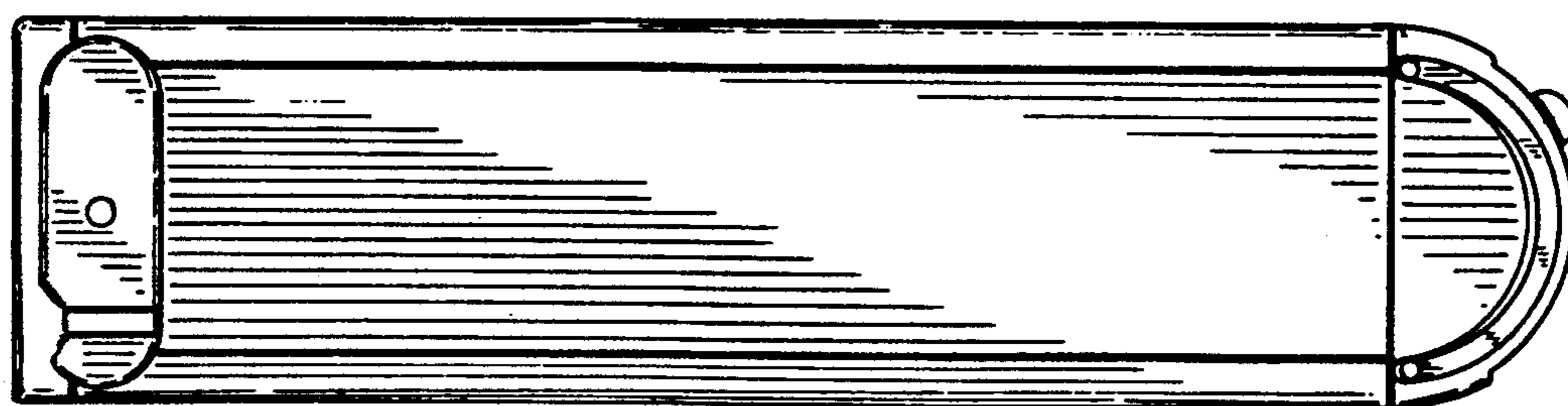

FIG.-8