

[54] WATER SPORTS BOARD

4,629,434 12/1986 Monreal 441/65
4,781,141 11/1988 Webb et al. 114/288

[75] Inventors: Ronald J. Olson; Robert B. Carlson,
both of Bloomington, Minn.

[73] Assignee: Wetsled Enterprises, Inc., Edina,
Minn.

[**] Term: 14 Years

[21] Appl. No.: 393,320

[22] Filed: Aug. 14, 1989

[52] U.S. Cl. D21/228; D21/236;
D12/307

[58] Field of Search D21/228, 236, 237;
114/288, 289, 290, 291, 56; 441/65-79;
D12/300, 307

[56] References Cited

U.S. PATENT DOCUMENTS

D. 265,116	6/1982	Churchill	D21/228
D. 276,359	11/1984	Churchill	D21/228
D. 290,151	6/1987	Cashmere	D21/228
D. 299,847	2/1989	Shanelec	D21/228
D. 300,841	4/1989	Minurri	D21/228
D. 301,029	5/1989	Duclo et al.	D12/300
3,952,354	4/1976	Turner	9/310 B
4,331,340	5/1982	Bolen	280/12 R
4,439,165	3/1984	Rothstein	441/74
4,619,619	10/1986	Muse, Jr.	441/65

OTHER PUBLICATIONS

HydroSlide, 1989, The Number One Kneeboard.

Primary Examiner—Kay H. Chin

Attorney, Agent, or Firm—R. Lawrence Buckley

[57] CLAIM

The ornamental design for a water sports board, as shown and described.

DESCRIPTION

FIG. 1 is a front and top perspective view of a water sports board showing our new design;
 FIG. 2 is a front elevational view thereof;
 FIG. 3 is a rear elevational view thereof;
 FIG. 4 is a top plan view thereof;
 FIG. 5 is a bottom plan view thereof;
 FIG. 6 is a right side elevational view thereof, the left side thereof being a mirror image of the right side;
 FIG. 7 is a cross sectional view thereof, taken along line 7—7 of FIG. 2;
 FIG. 8 is a cross sectional view thereof, taken along line 8—8 of FIG. 4;
 FIG. 9 is a cross sectional view thereof, taken along line 9—9 of FIG. 4; and
 FIG. 10 is a cross sectional view thereof, taken along line 10—10 of FIG. 4.

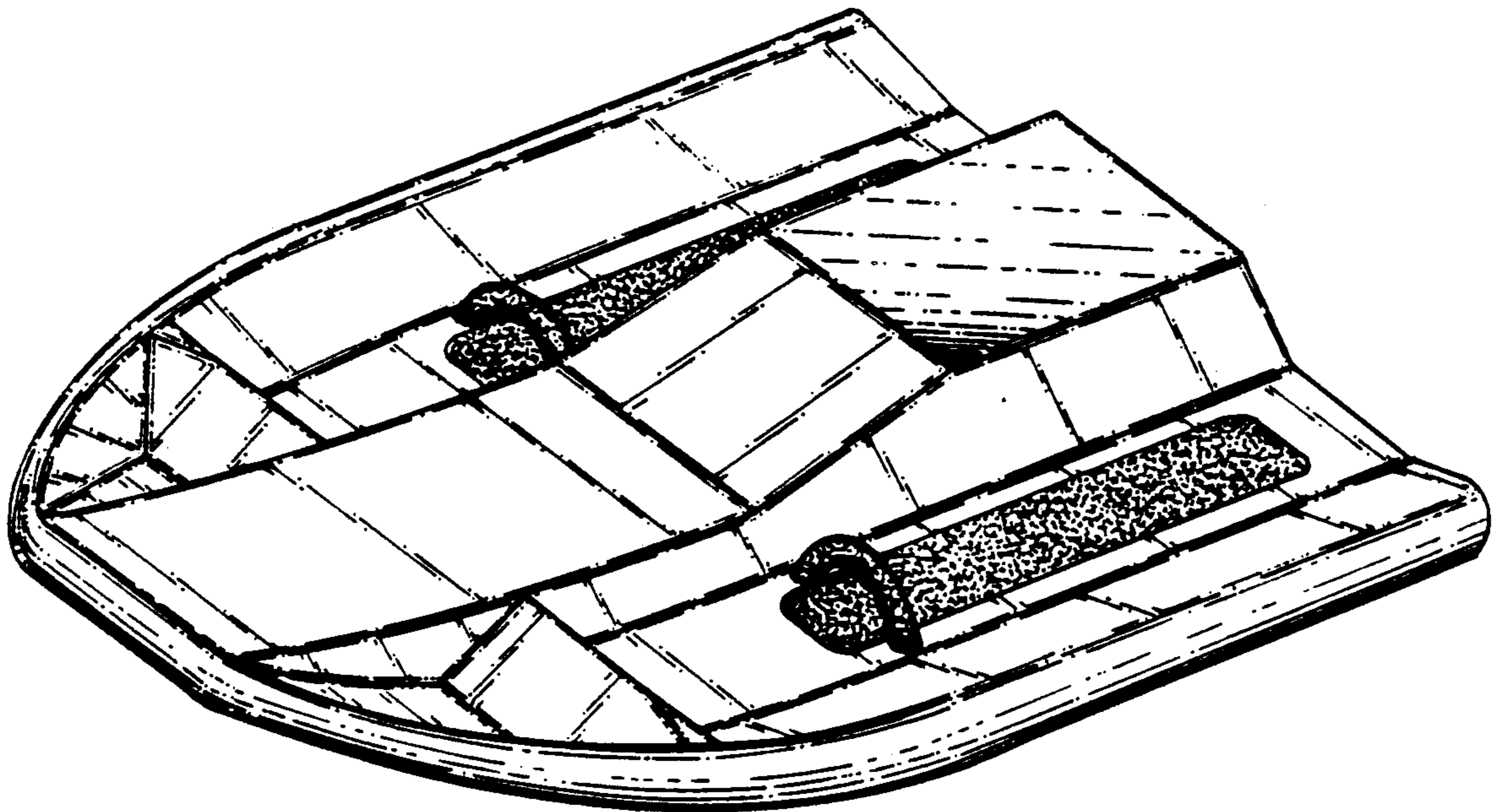

FIG. 1

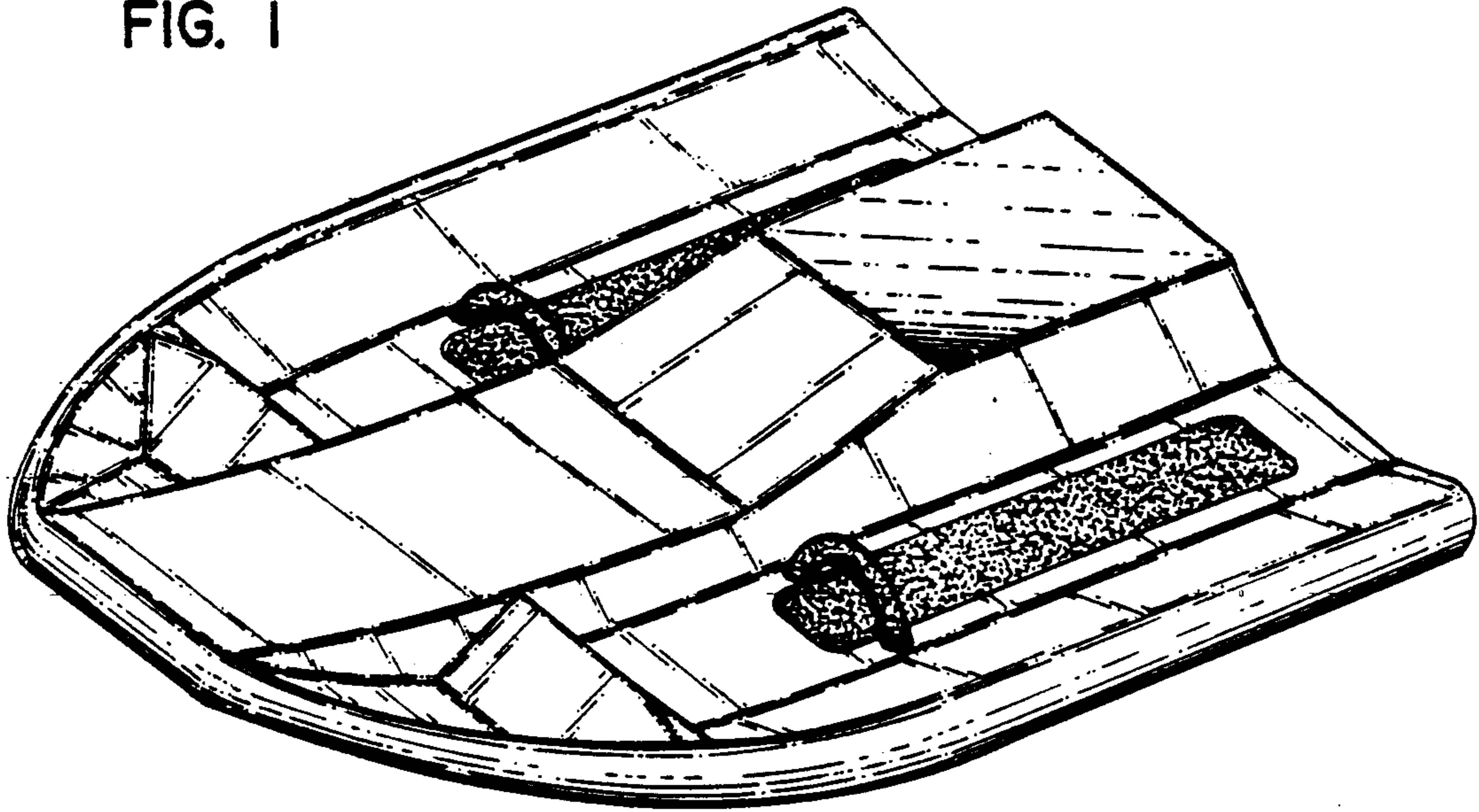

FIG. 3

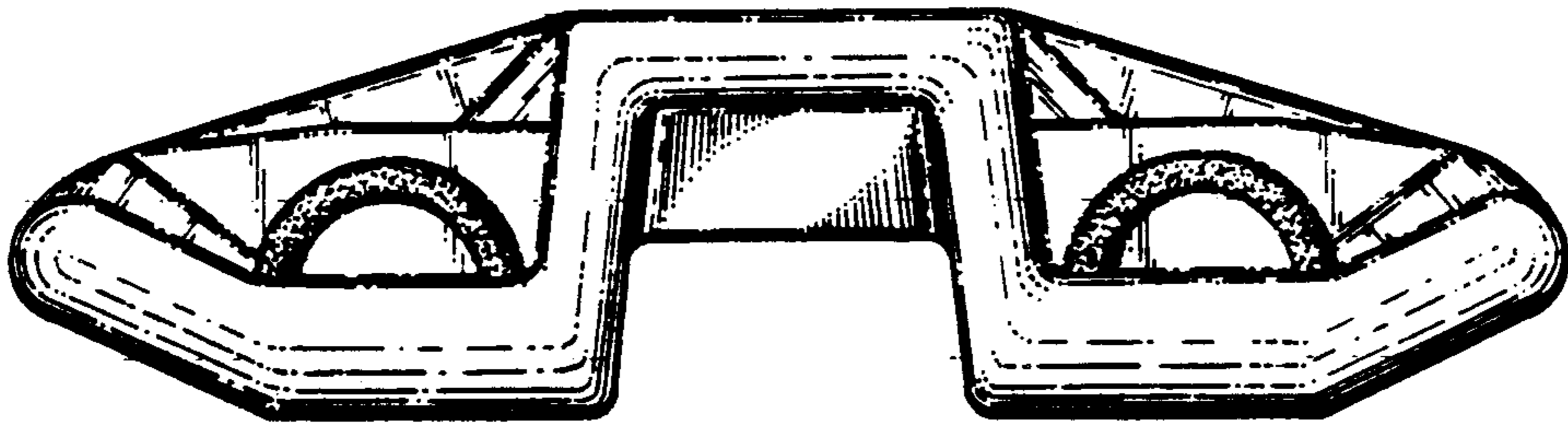
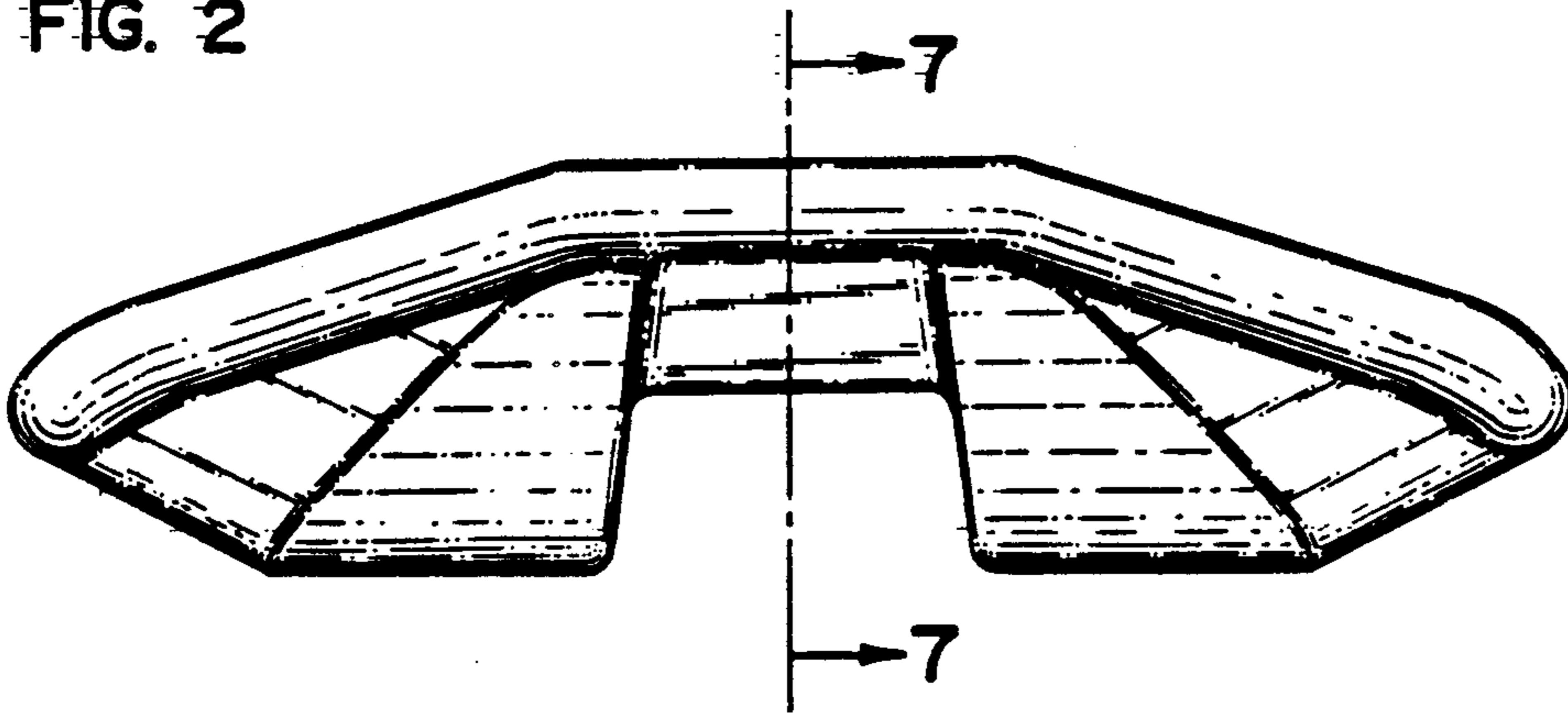

FIG. 2



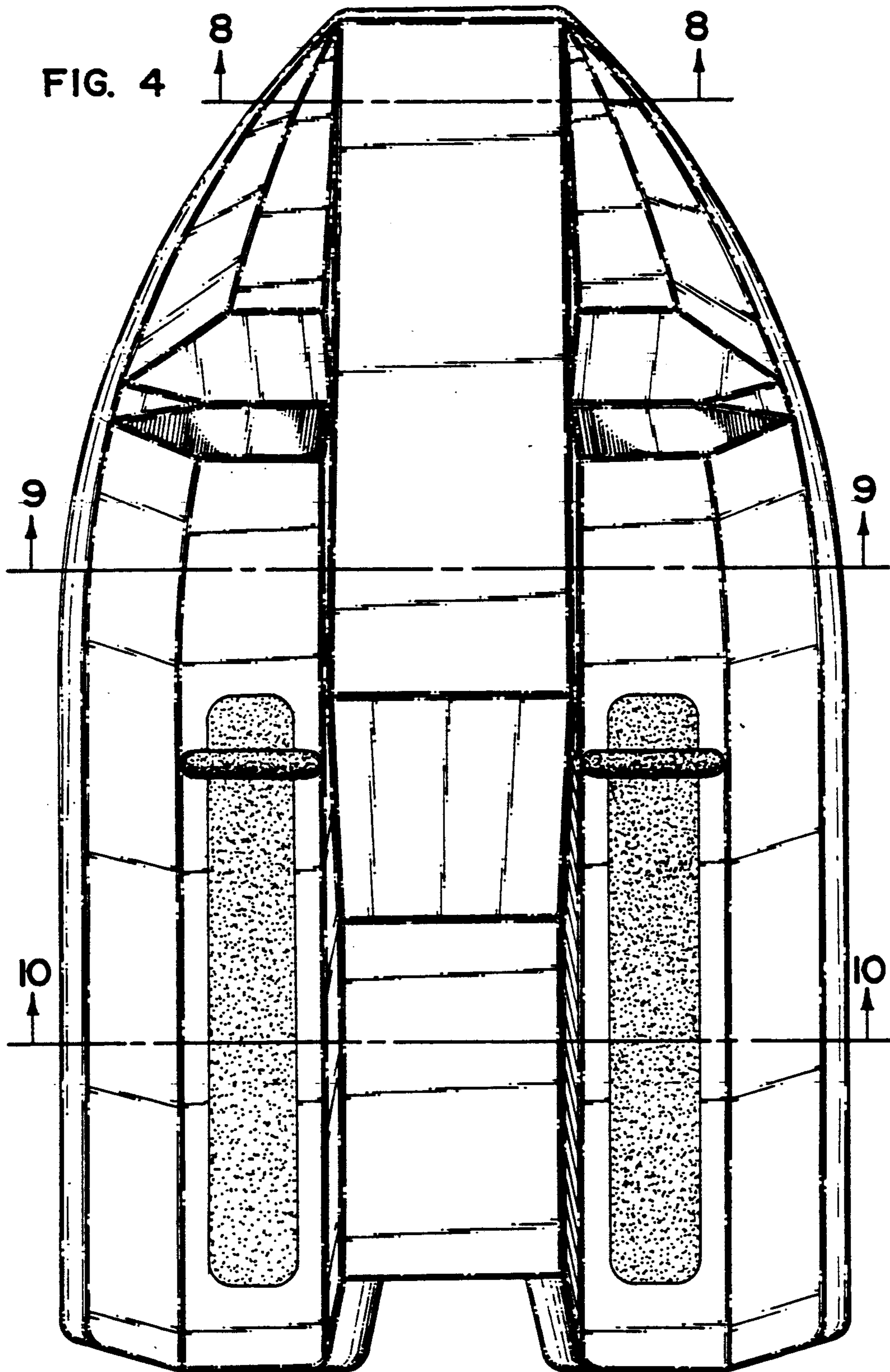

FIG. 5

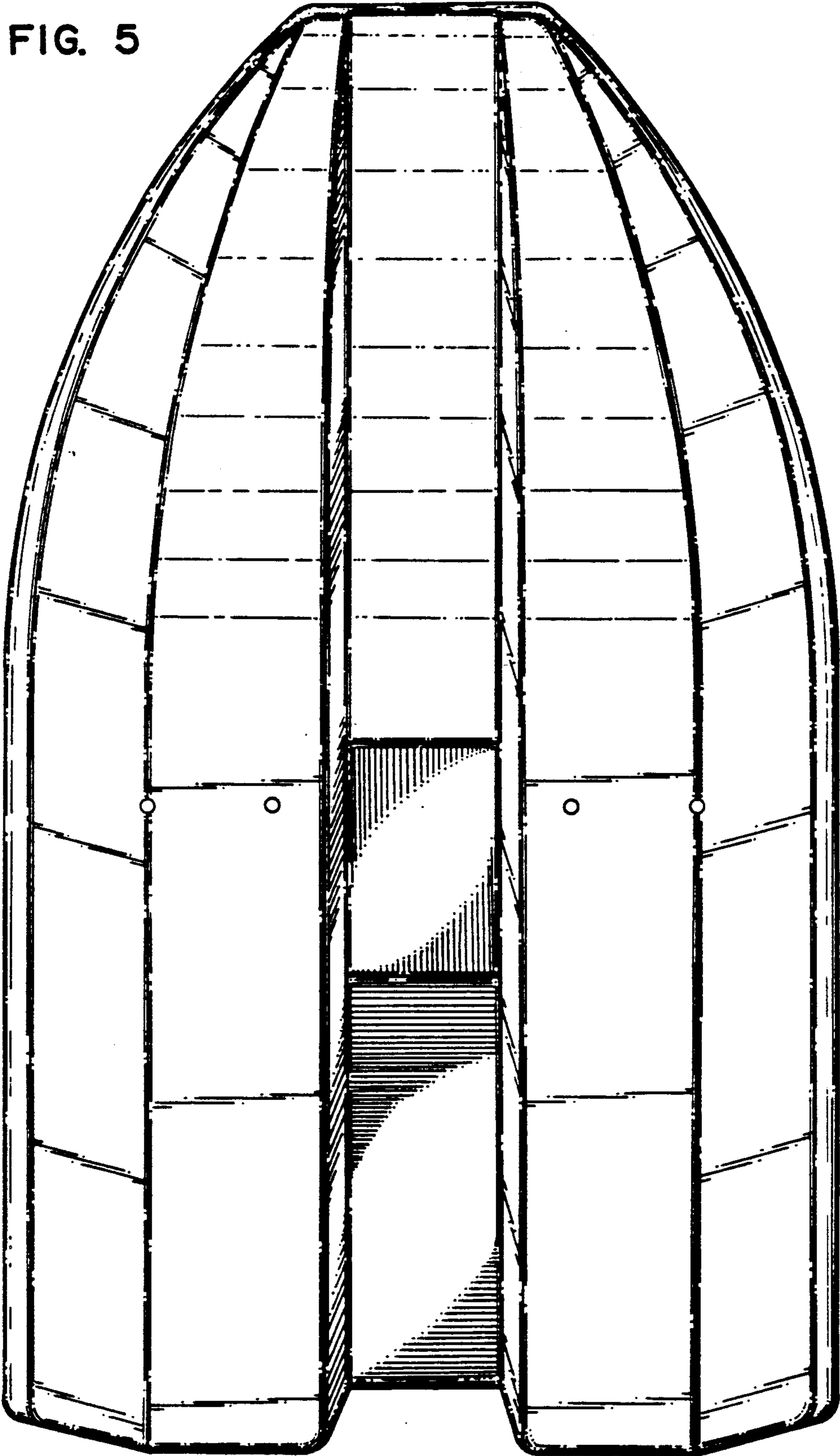

FIG. 6

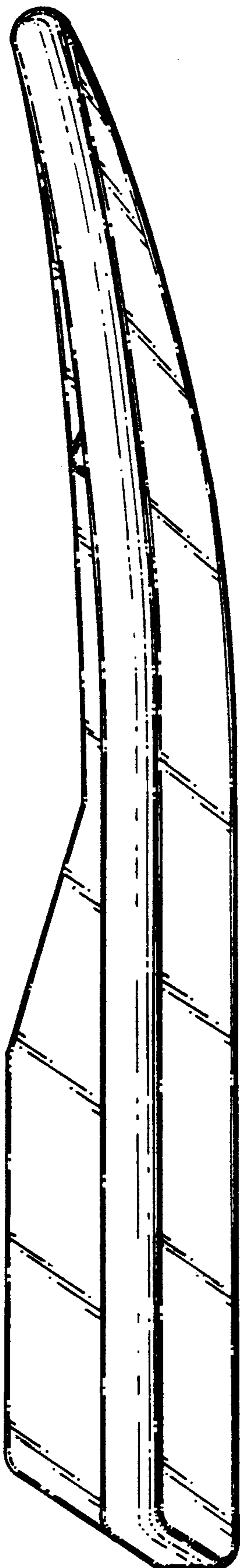

FIG. 7

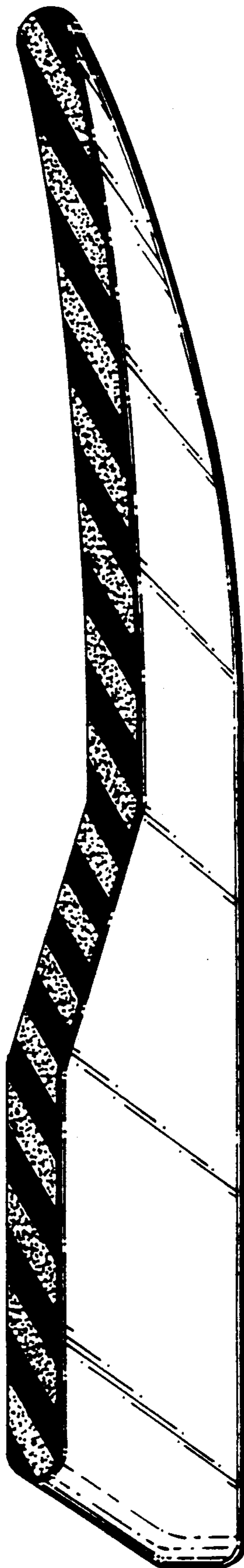

FIG. 8



FIG. 9



FIG. 10

