

[54] BONING KNIFE

[76] Inventor: Edwin L. Scheuerman, Rte. #1, Box 367, Exeter, Mo. 65647

[**] Term: 14 Years

[21] Appl. No.: 144,075

[22] Filed: Jan. 15, 1988

[52] U.S. Cl. D7/693; D7/649; D8/98

[58] Field of Search D7/642-646, D7/649-652, 664, 395, 693; D22/118; D8/98, 107; 30/331, 149, 125, 123, 136, 143, 151, 344, 123.7; 17/46

[56] References Cited

U.S. PATENT DOCUMENTS

D. 141,315	5/1945	Simeone	D22/118
D. 296,657	7/1988	Le Feber	D8/98
1,147,853	7/1915	Enzler	D7/649 X
2,606,364	8/1952	Gustafson	30/149
3,290,720	12/1966	Gordon	30/149 X

OTHER PUBLICATIONS

Gun World, Nov. 1985, p. 61, Bottom Row-Knife Shown; "Hitler Youth Knife".

Primary Examiner—Winifred E. Herrmann
Attorney, Agent, or Firm—Jerry T. Kearns

[57] CLAIM

The ornamental design for a boning knife, as shown and described.

DESCRIPTION

FIG. 1 is a side elevational view of a boning knife showing my new design;
 FIG. 2 is a side elevational view from the opposite side thereof;
 FIG. 3 is a top plan view thereof;
 FIG. 4 is a bottom plan view thereof;
 FIG. 5 is a front elevational view thereof;
 FIG. 6 is a rear elevational view thereof;
 FIG. 7 is a bottom, front, and right side perspective view thereof; and
 FIG. 8 is a top, front, and right side perspective view thereof.

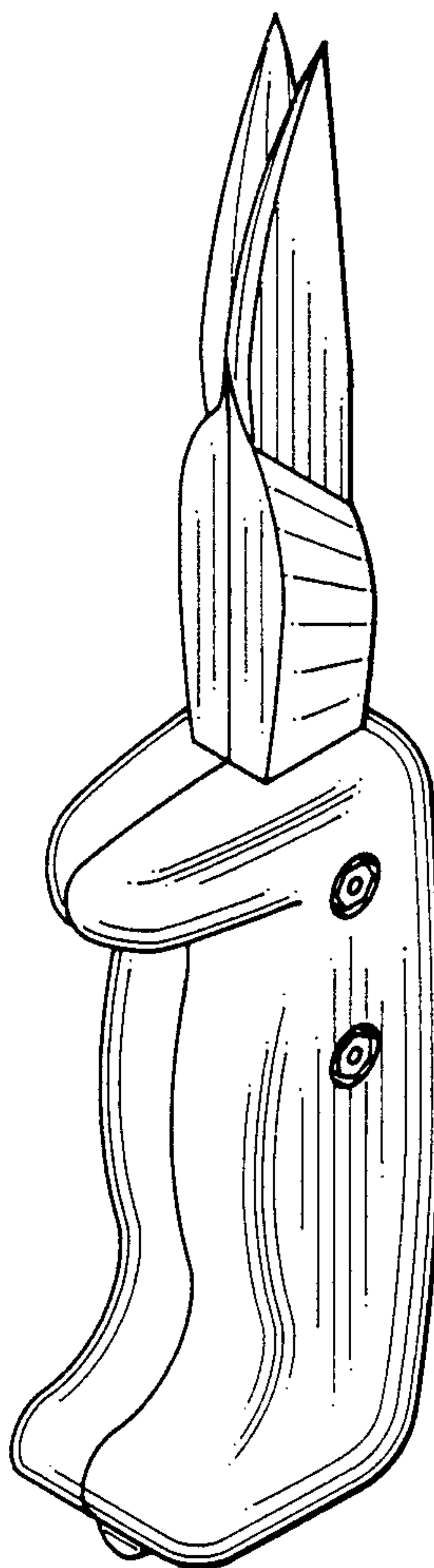
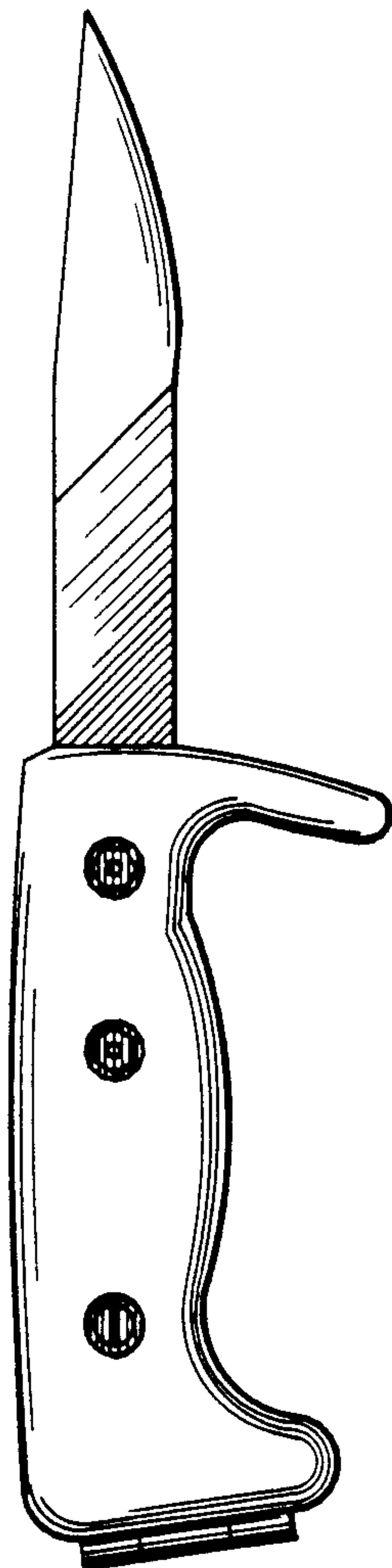

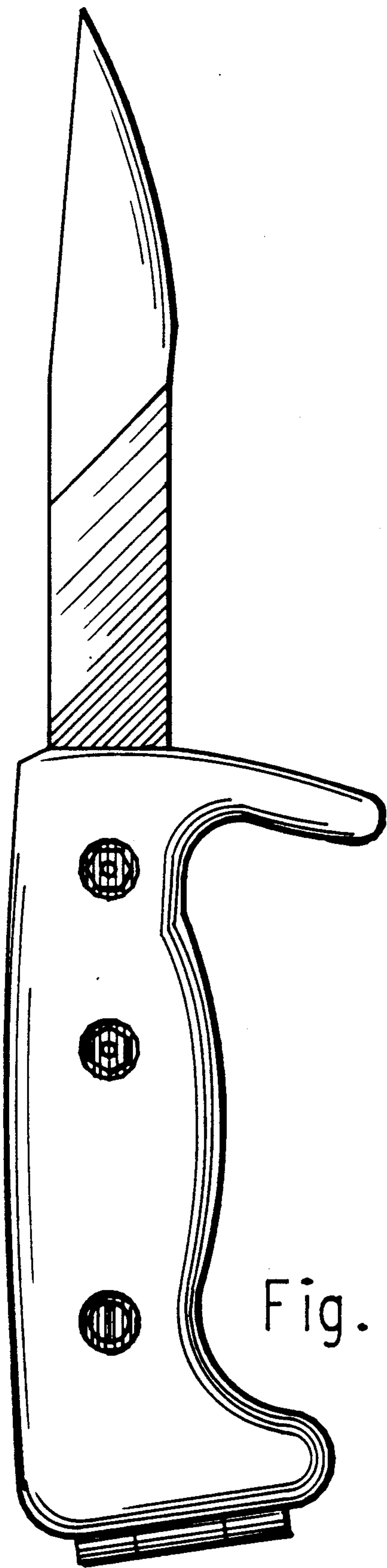

Fig. 1

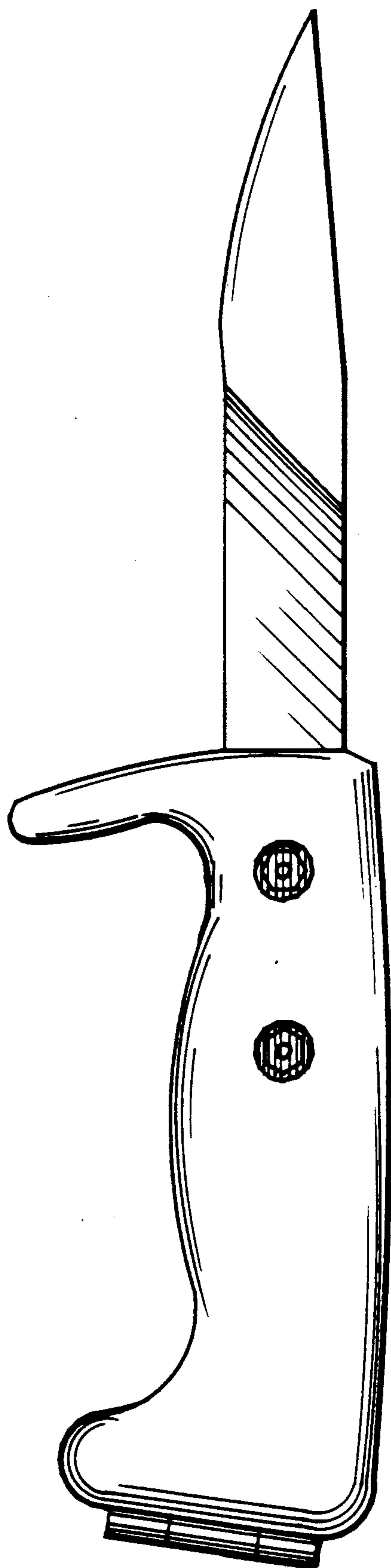

Fig. 2

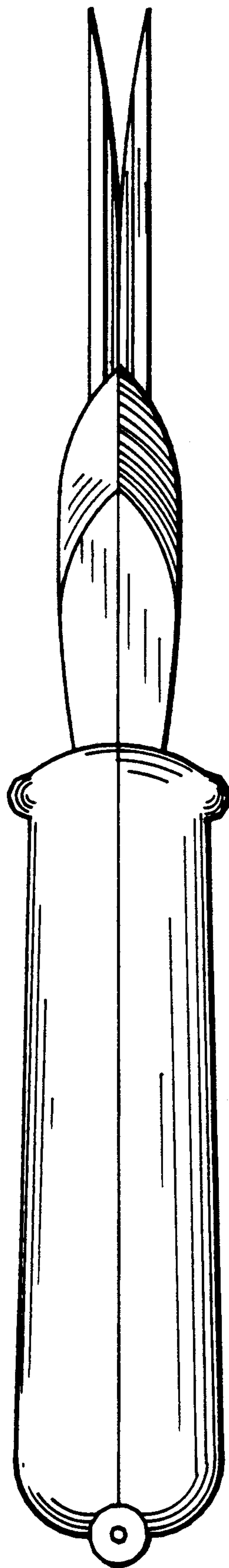

Fig. 3

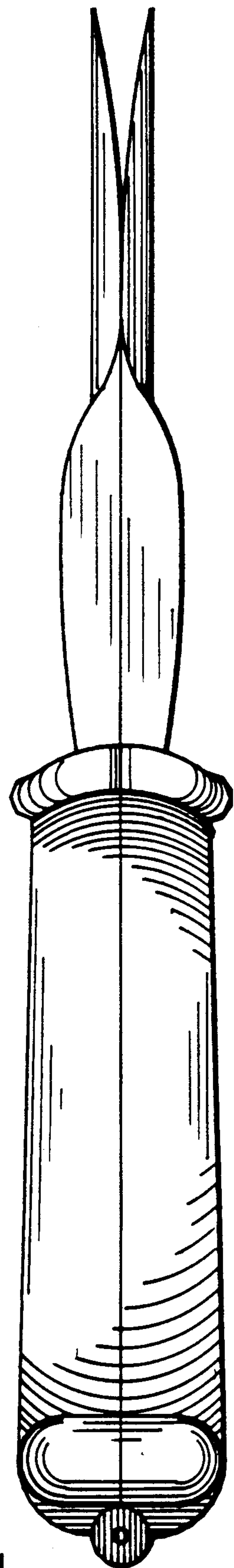

Fig. 4

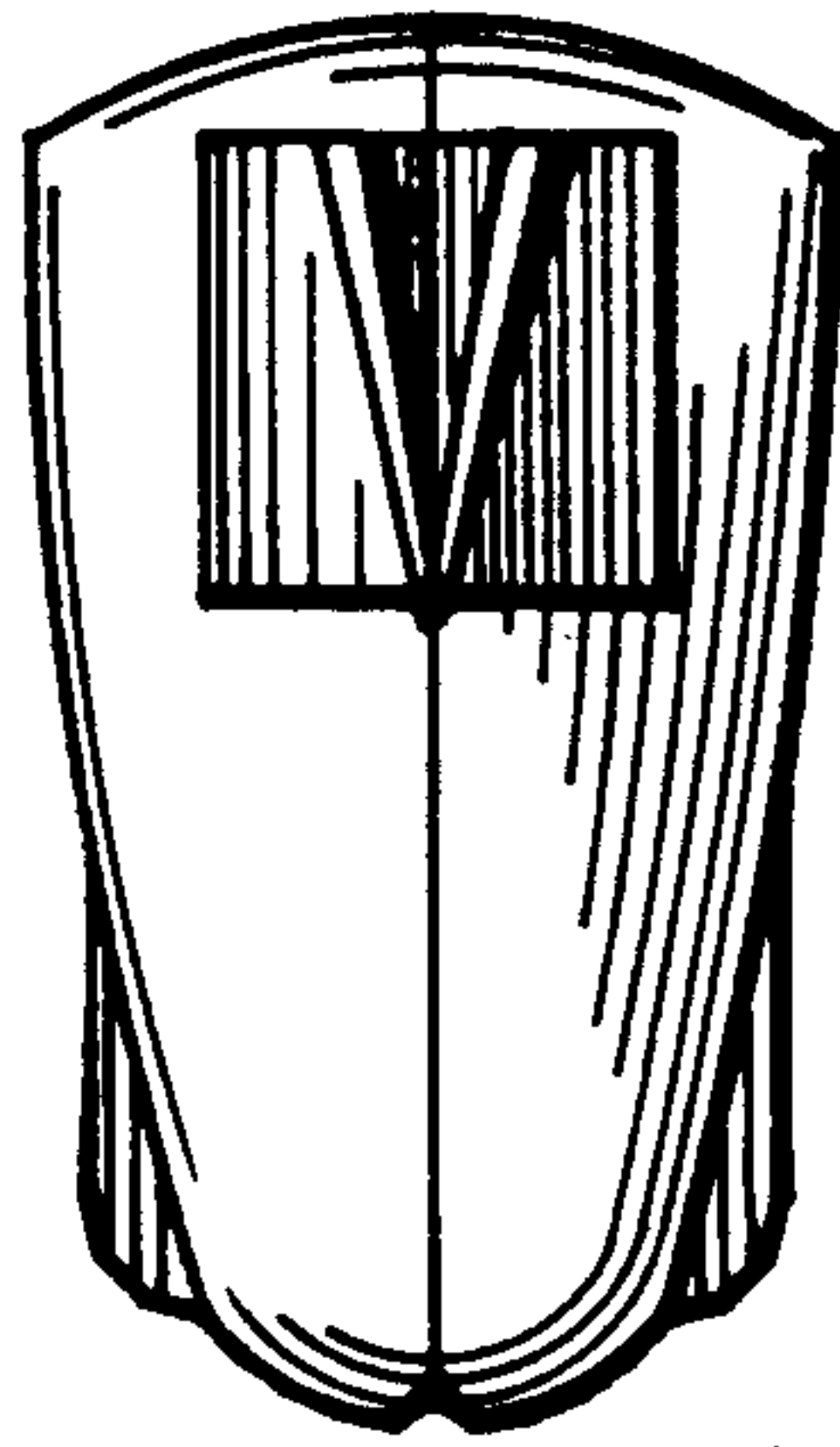

Fig. 5

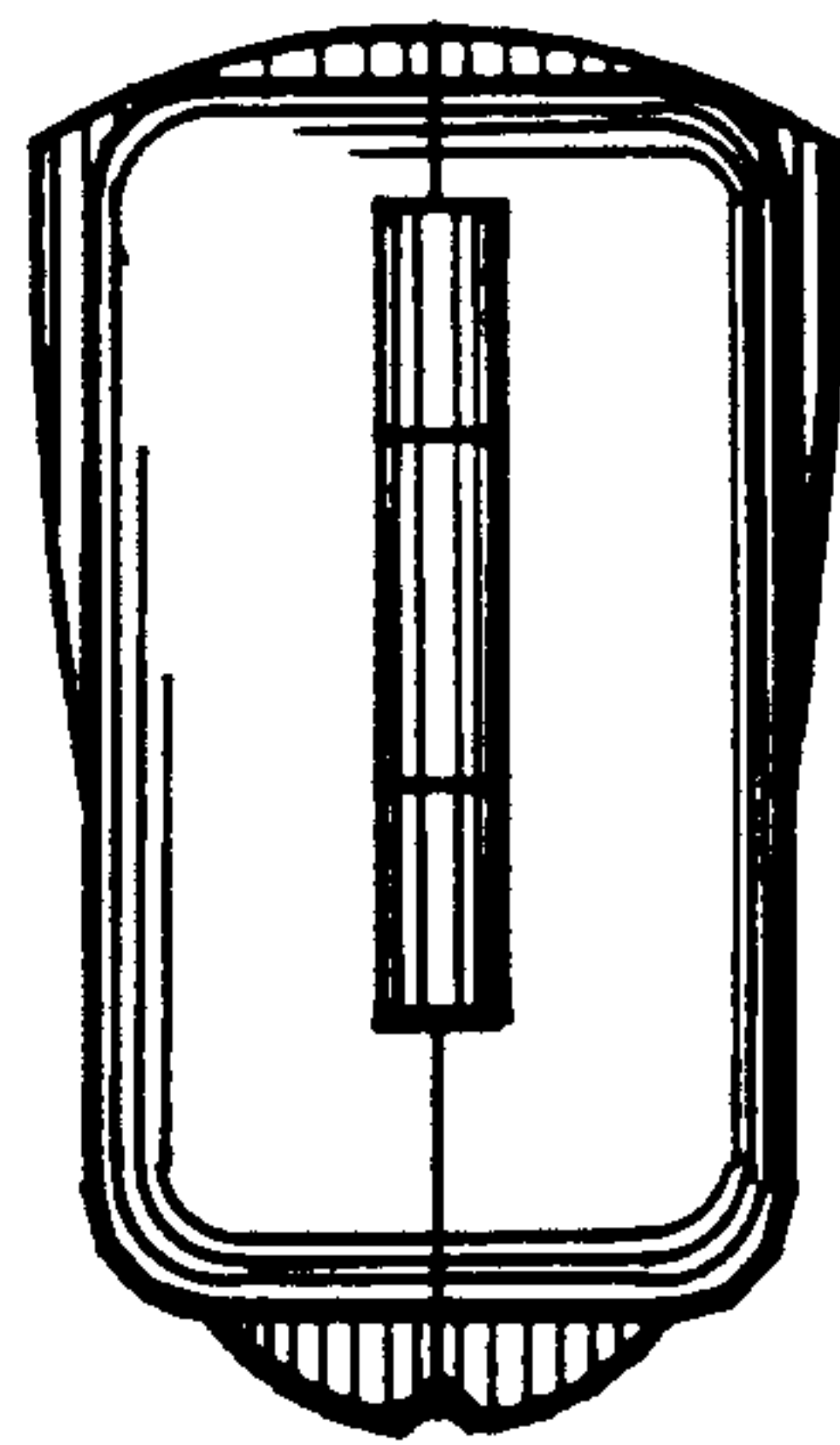

Fig. 6

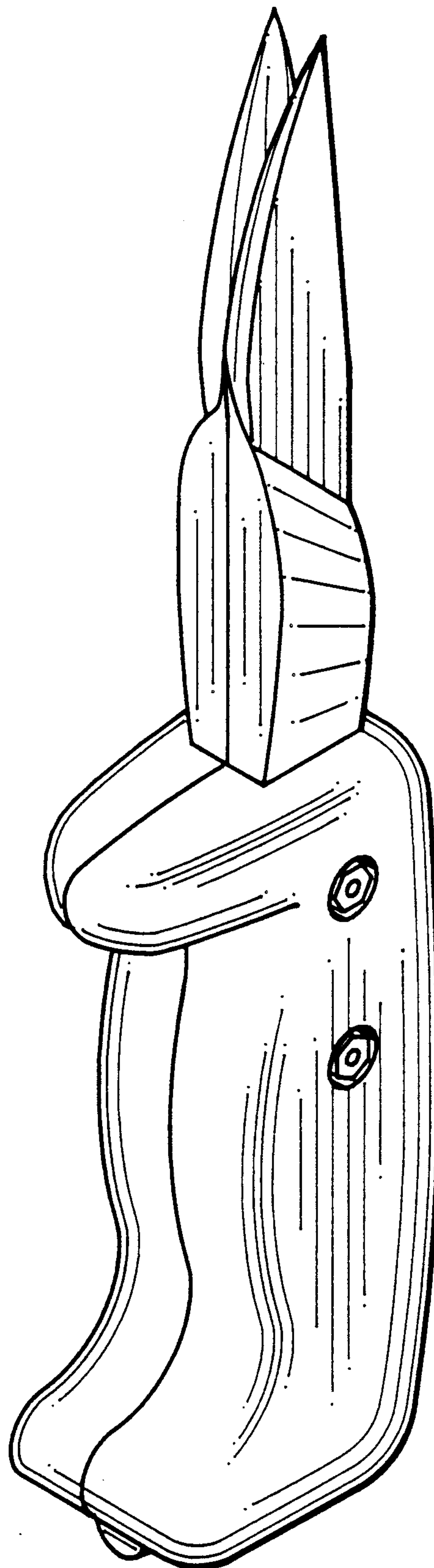

Fig. 7

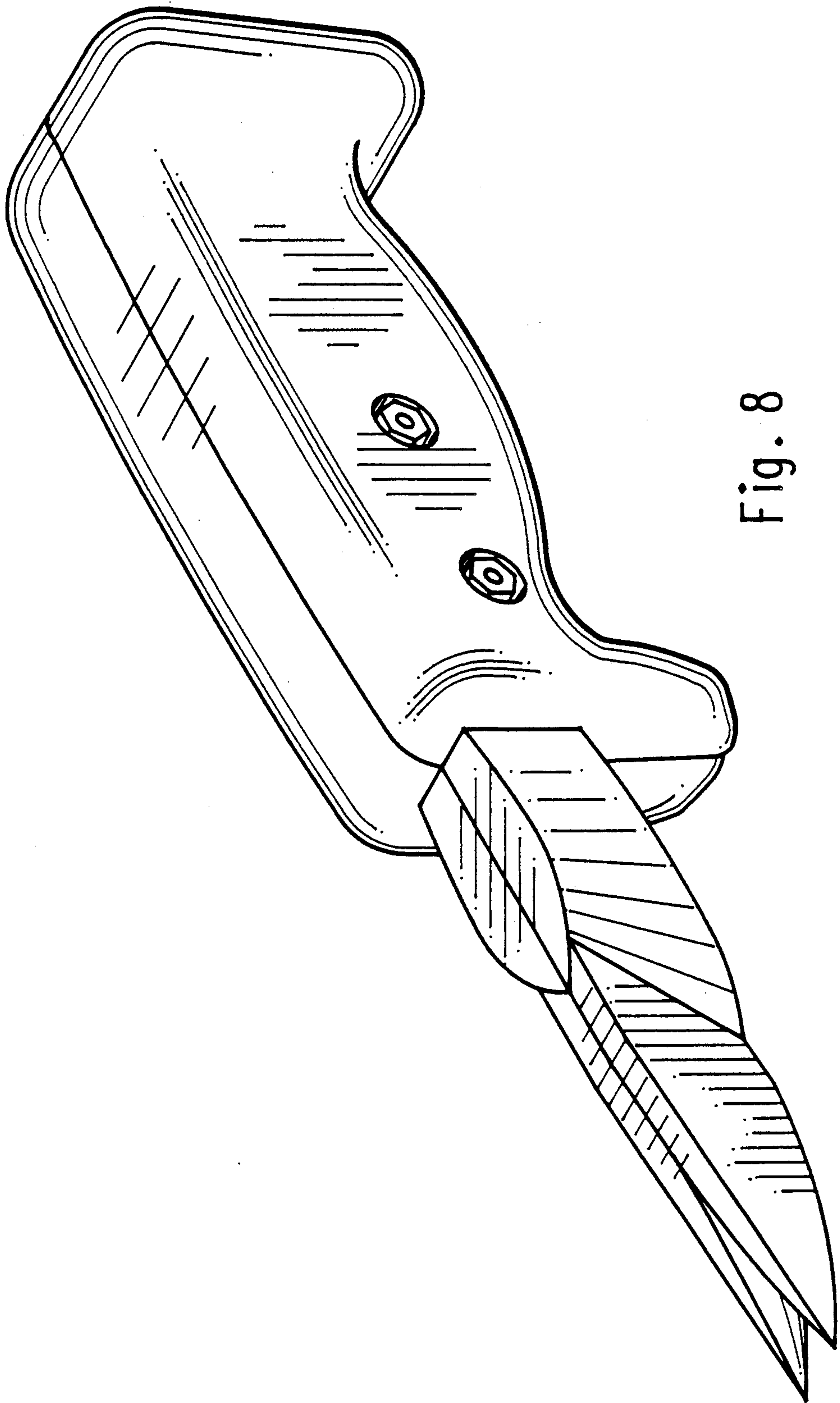

Fig. 8