

United States Patent [19]

Komada et al.

[11] Patent Number: **Des. 315,574**

[45] Date of Patent: **** Mar. 19, 1991**

[54] **COPYING MACHINE**

[75] Inventors: **Takeshi Komada, Tsurumi; Minoru Aoyama, Tokyo; Tomohiko Hirata, Kawasaki, all of Japan**

[73] Assignee: **Canon Kabushiki Kaisha, Japan**

[**] Term: **14 Years**

[21] Appl. No.: **180,795**

[22] Filed: **Apr. 12, 1988**

[30] **Foreign Application Priority Data**

Oct. 15, 1987 [JP] Japan 62-42291
[52] U.S. Cl. **D18/37; D18/39**
[58] Field of Search **D18/13, 36-40;**
D14/107, 111, 114; 355/200, 210, 233, 234

[56] **References Cited**

U.S. PATENT DOCUMENTS

D. 280,634 9/1985 Imada et al. D18/37
D. 285,800 9/1986 Kadota D18/37
D. 299,927 2/1989 Aoyama D18/37
4,490,035 12/1984 Sugiura 355/234

Primary Examiner—Nelson C. Holtje
Assistant Examiner—Caron D. Veynar

[57] **CLAIM**

The ornamental design for a copying machine, as shown and described.

DESCRIPTION

FIG. 1 is a front elevational view of a copying machine showing our new design;
FIG. 2 is a rear elevational view thereof;
FIG. 3 is a top plan view thereof;
FIG. 4 is a bottom plan view thereof;
FIG. 5 is a left side elevational view thereof;
FIG. 6 is a right side elevational view thereof; and
FIG. 7 is a perspective view thereof.

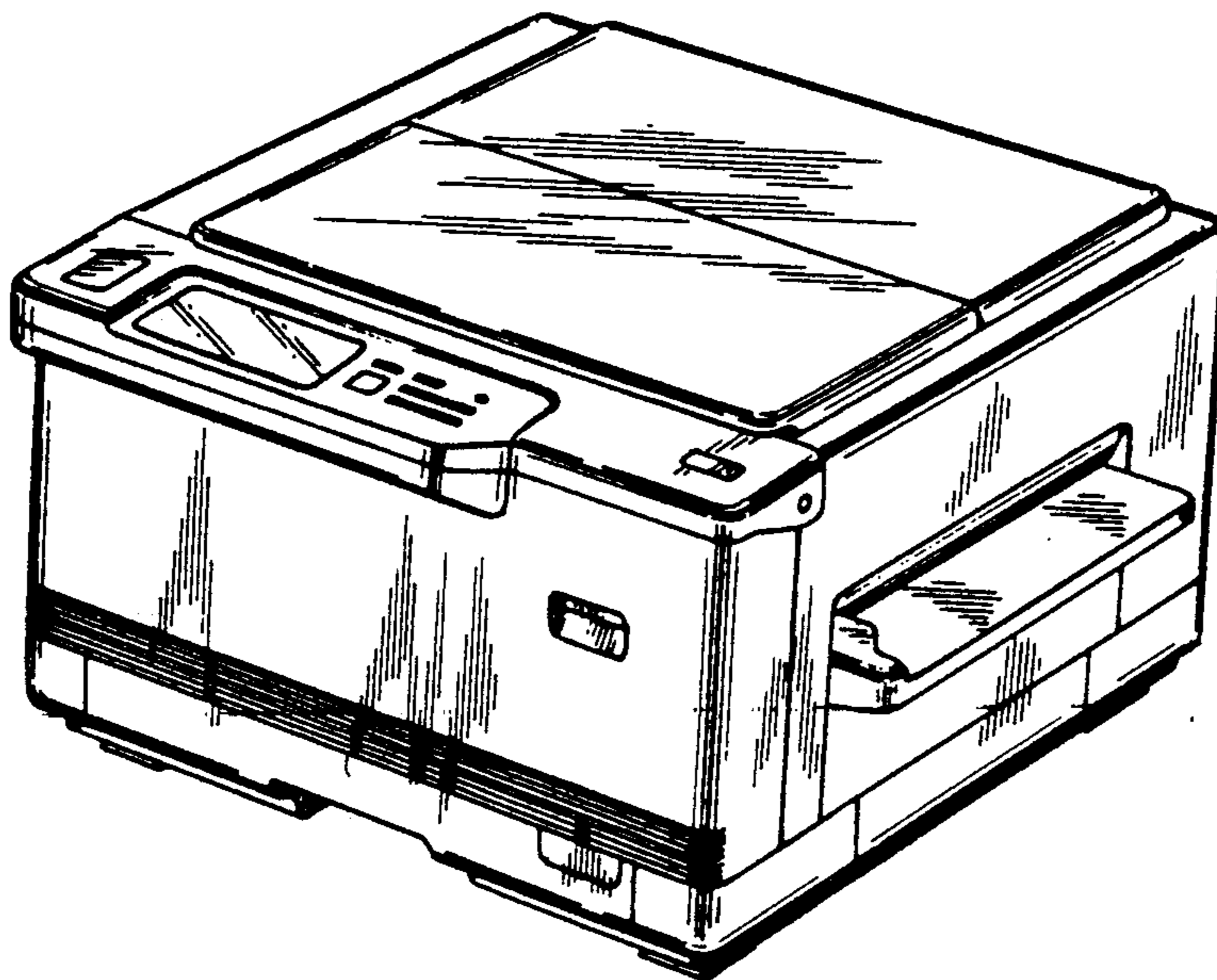

FIG. 1

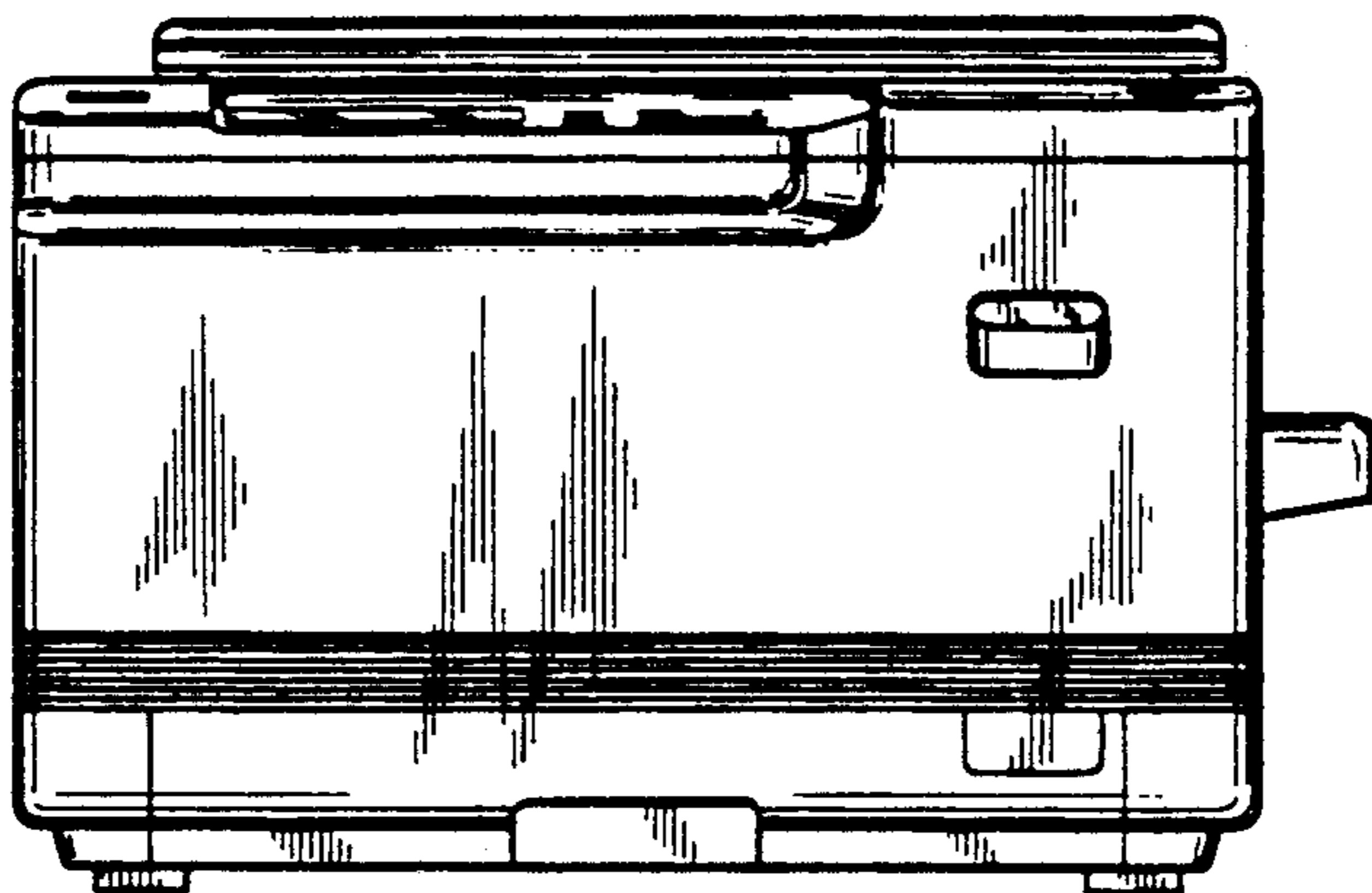

FIG. 2

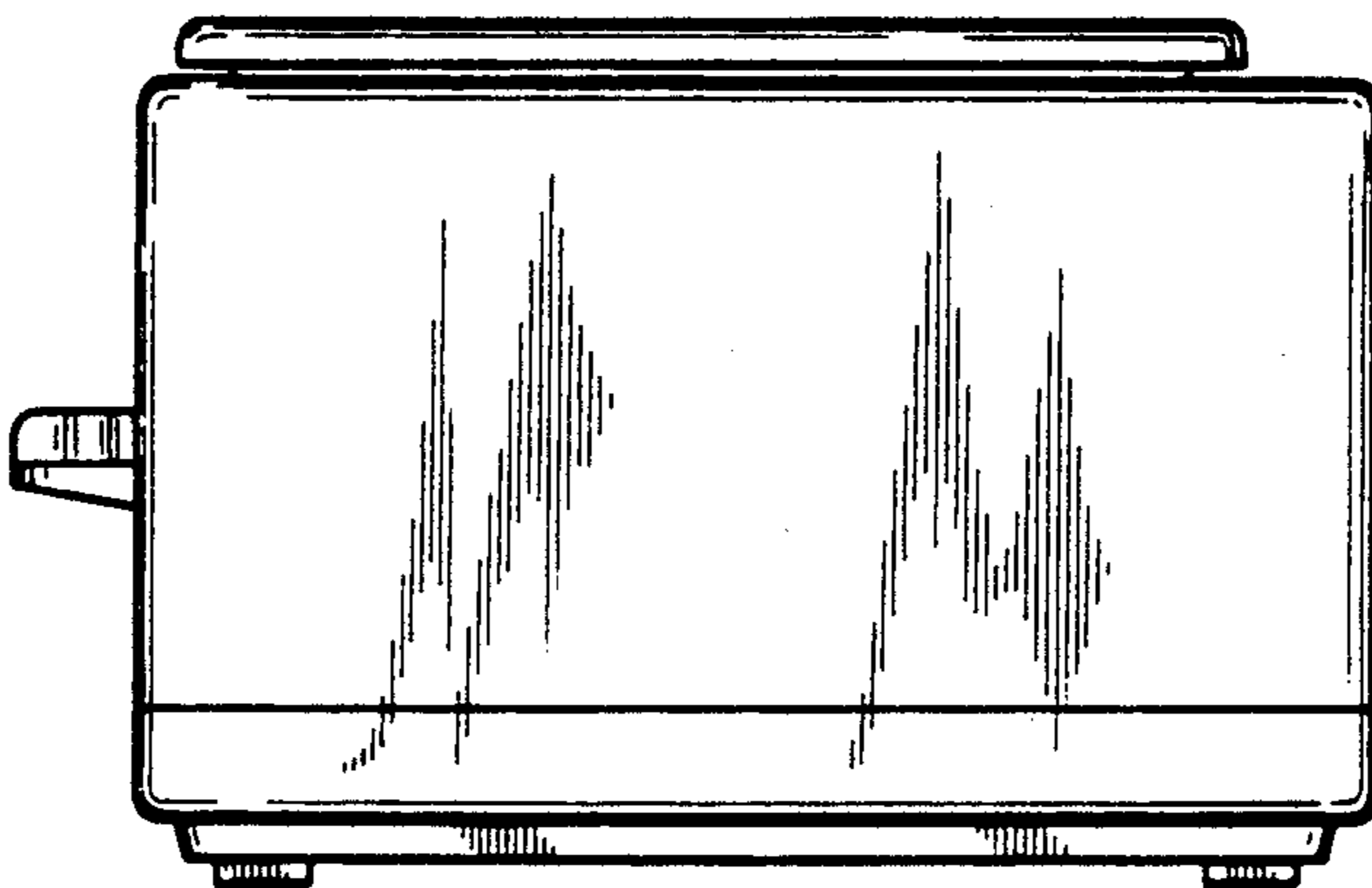

FIG. 3

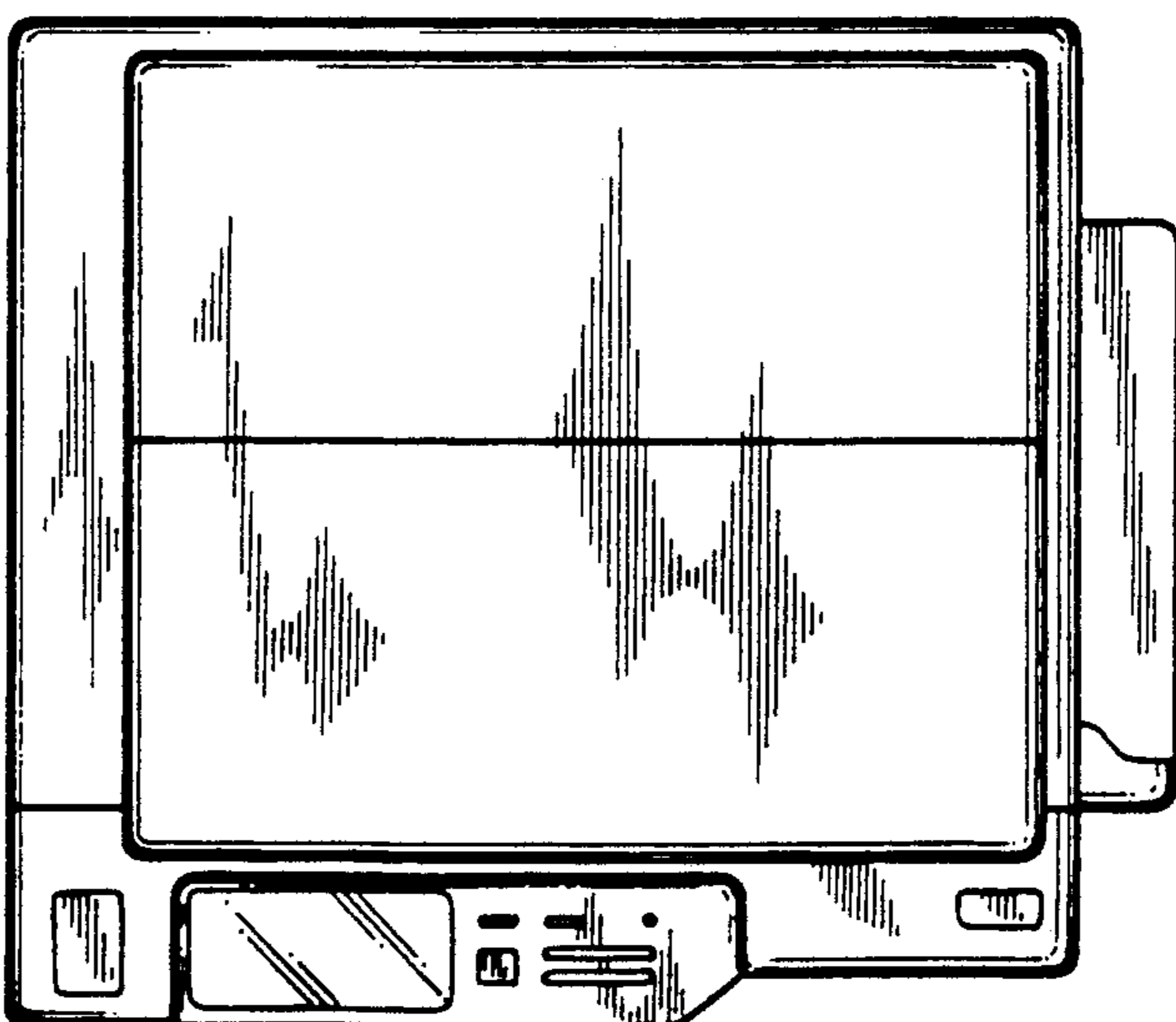

FIG. 4

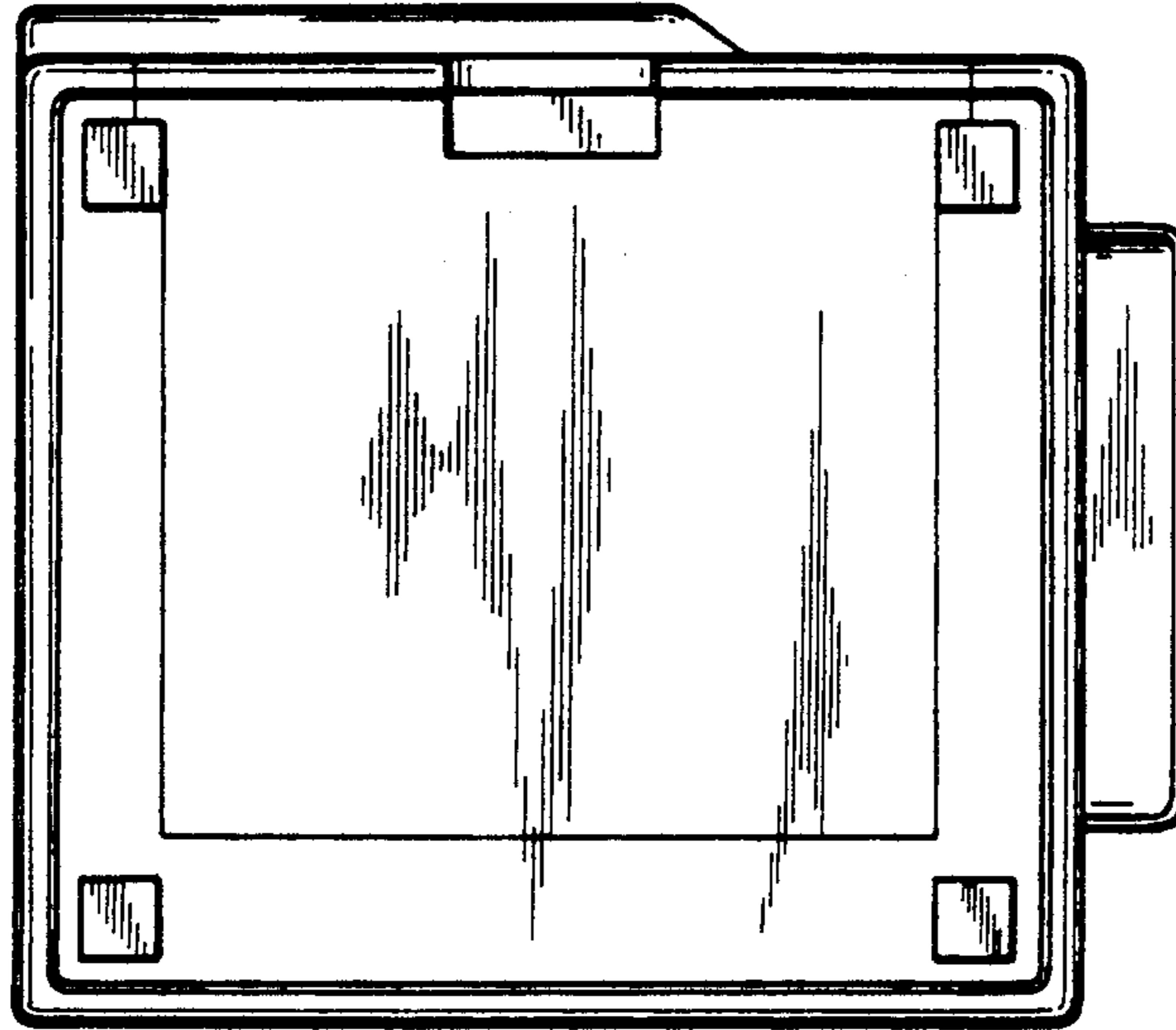

FIG. 5

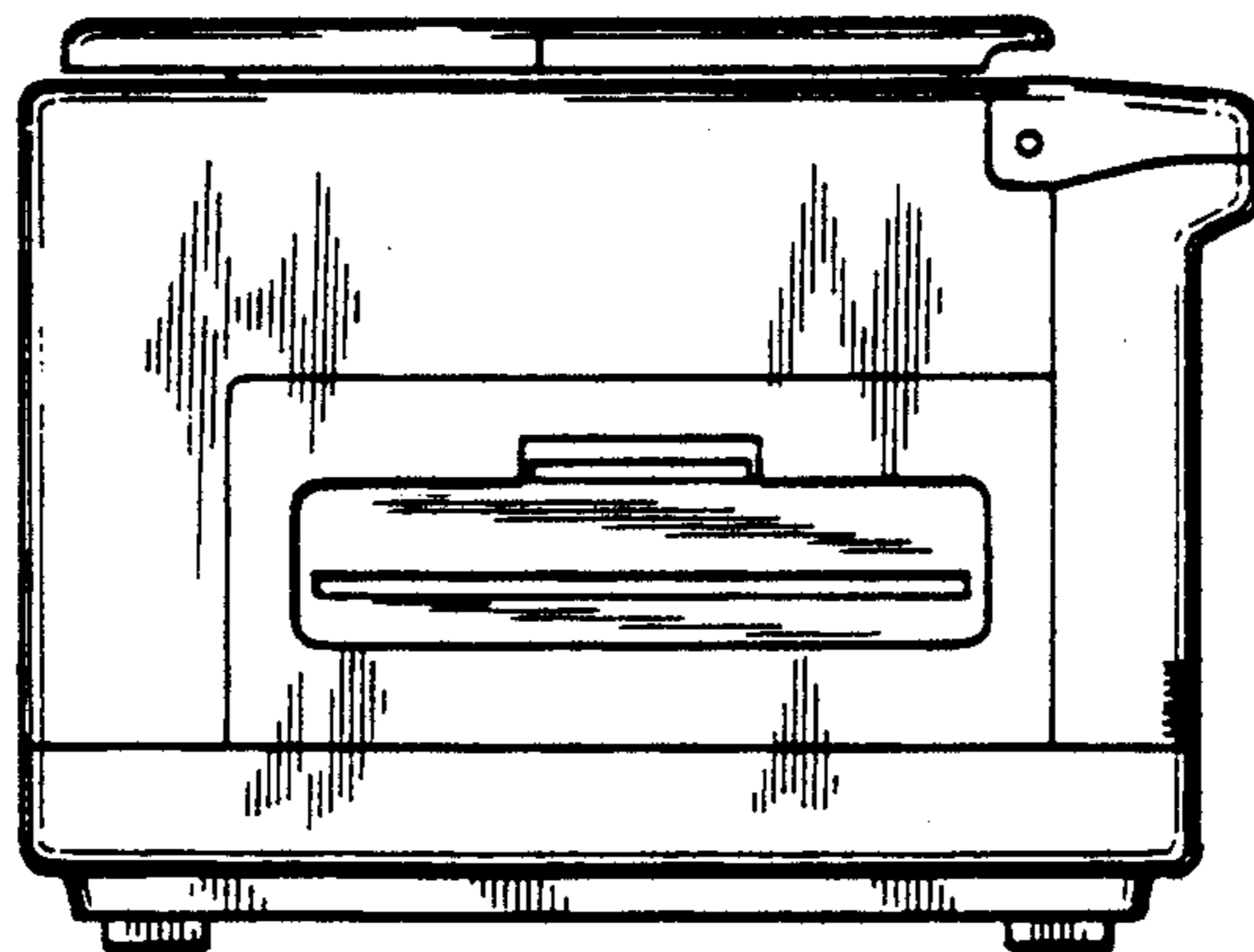

FIG. 6

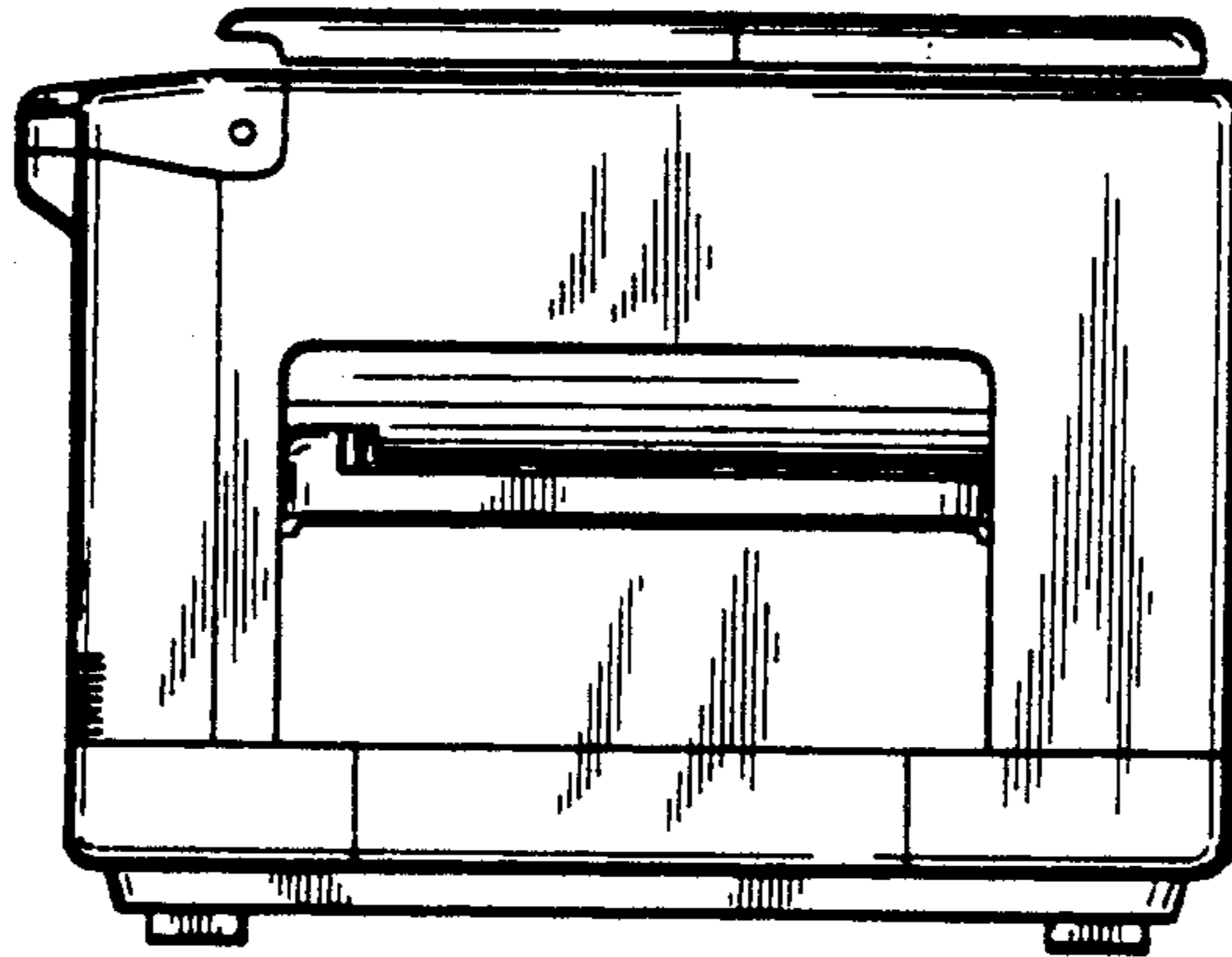

FIG. 7

