

[54] PORTABLE COMPUTER

[75] Inventors: Myron F. Davis; Ted F. Kelley, Jr.; Randall W. Martin, all of Boca Raton, Fla.; Tomoyuki Takahashi, Fujisawa, Japan; Ernest Wittner, Boca Raton, Fla.

[73] Assignee: International Business Machines Corporation, Armonk, N.Y.

[**] Term: 14 Years

[21] Appl. No.: 241,376

[22] Filed: Sep. 9, 1988

[52] U.S. Cl. D14/106

[58] Field of Search D14/100, 101, 106, 113, D14/115, 124-125; D18/1, 7, 11, 12; 235/145 A, 145 R; 340/700, 706, 711, 712; 341/22, 23; 358/249, 254; 364/706-710; 312/208, 7.2; 248/917-925

[56] References Cited

U.S. PATENT DOCUMENTS

D. 289,292	4/1987	Ansell et al.	D14/106
D. 293,793	1/1988	Watanabe et al.	D14/106
D. 294,578	3/1988	Yubisui	D14/106
4,769,764	9/1988	Levanon	364/708
4,837,590	6/1989	Sprague	D14/106 X
4,864,523	9/1989	Sasaki	364/708

Primary Examiner—Wallace R. Burke
Assistant Examiner—Freda S. Nunn
Attorney, Agent, or Firm—Mark P. Kahler

[57] CLAIM

The ornamental design for a portable computer, as shown and described.

DESCRIPTION

FIG. 1 is a top, front, right side perspective view of the portable computer showing our new design.

FIG. 2 is a top, front, right side perspective view thereof, the keyboard being detached.

FIG. 3 is a bottom, rear, left side perspective view thereof.

FIG. 4 is a front elevational view thereof.

FIG. 5 is a front elevational view thereof with the computer in the closed position and the handle extended.

FIG. 6 is a rear elevational view thereof.

FIG. 7 is a right side elevational view thereof.

FIG. 8 is a left side elevational view thereof.

FIG. 9 is a top plan view thereof.

FIG. 10 is a bottom plan view thereof.

FIG. 11 is a top, front, right side perspective view thereof in the closed position and with the handle in the extended position;

FIG. 12 is a bottom, rear, left side perspective view thereof.

FIG. 13 is a right side elevational view thereof.

FIG. 14 is a left side elevational view thereof.

FIG. 15 is a top plan view thereof.

FIG. 16 is a bottom plan view thereof.

FIGS. 17 and 18 are respectively left and right side elevational views thereof with the keyboard's supports angled in the downward position.

The computer is shown in the open position in FIGS. 1, 2, 3, 4, 7, 8, 9, 10, 17 and 18. The computer is shown in closed position in the remaining views.

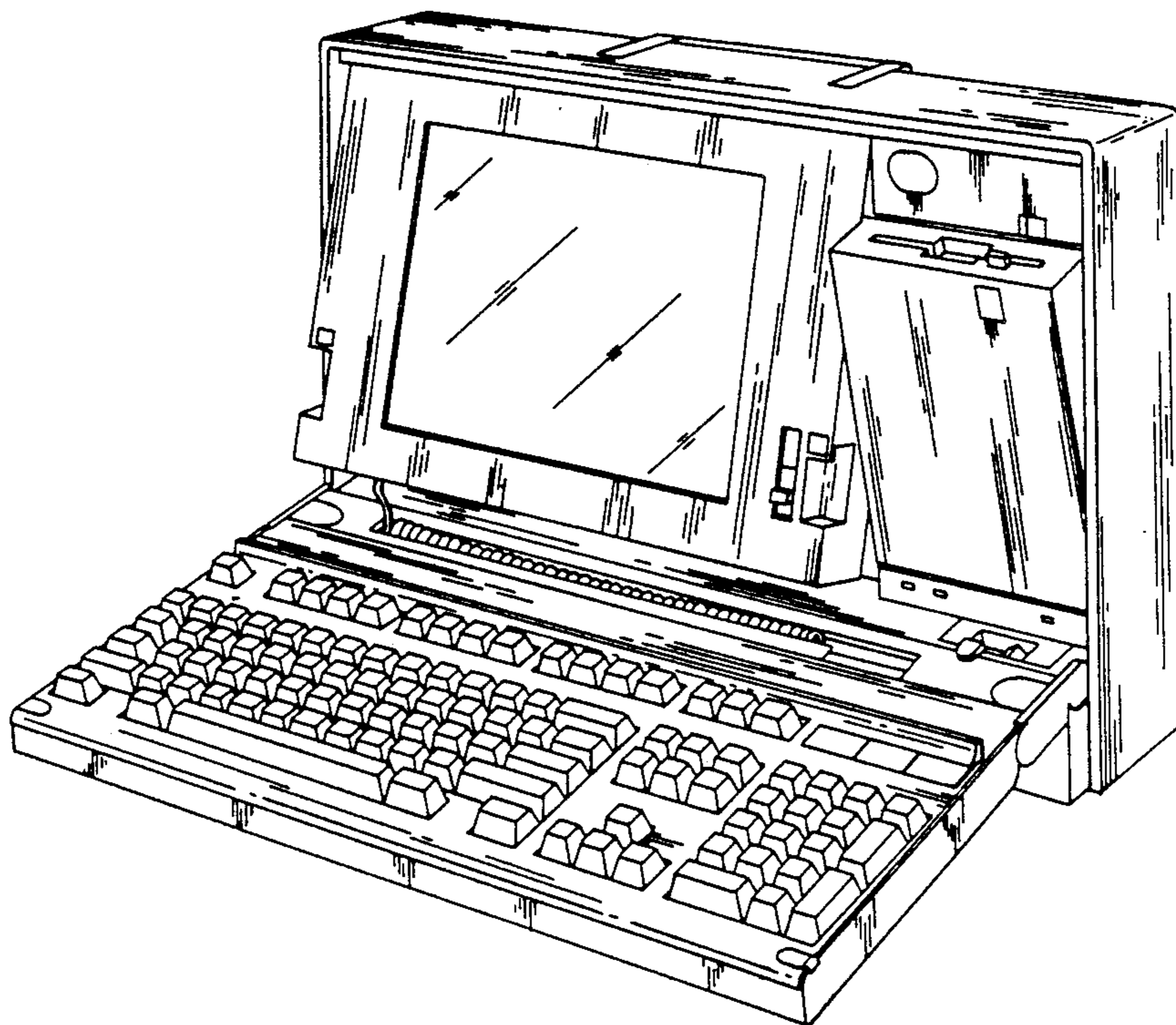

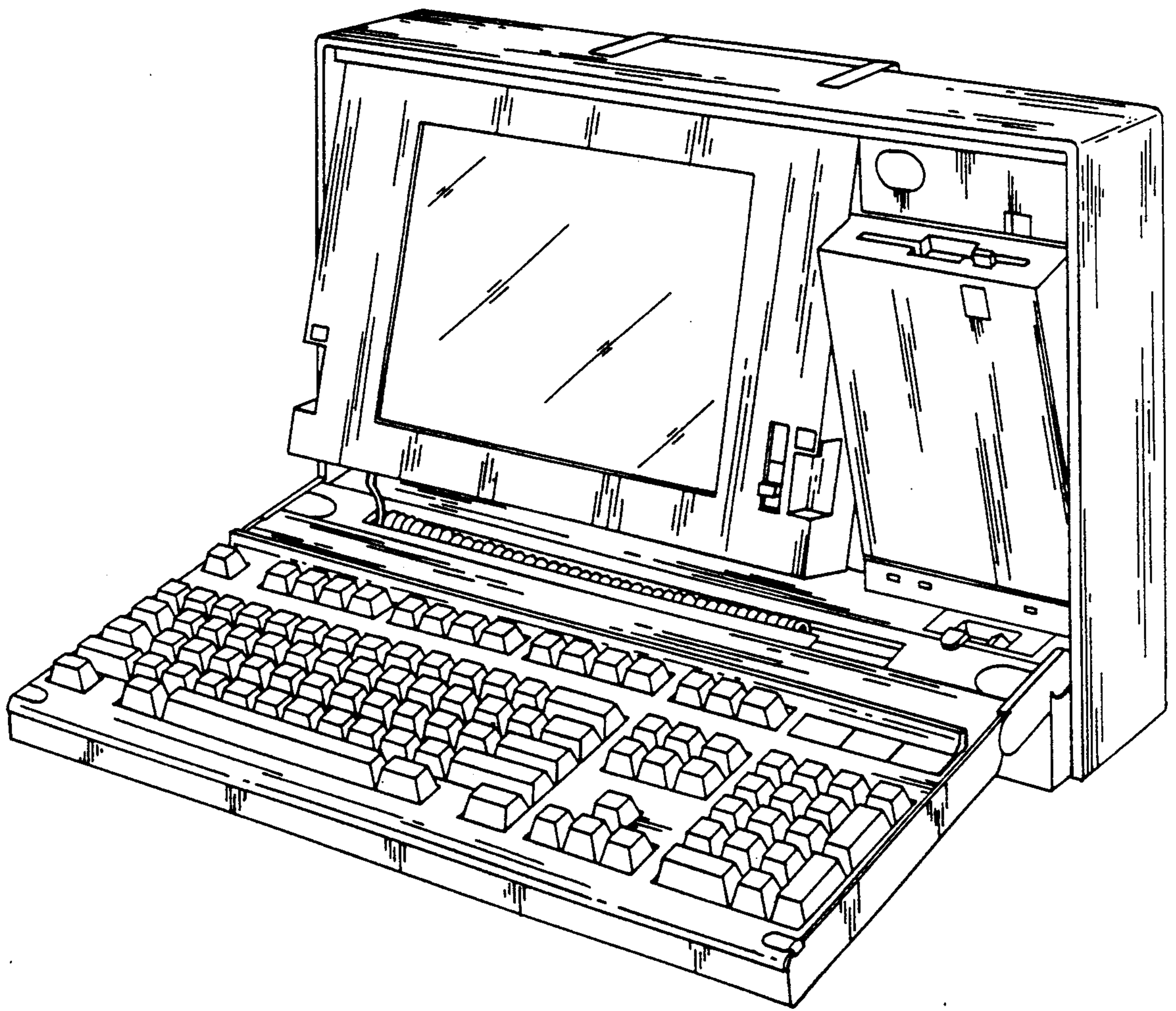

FIG. 1

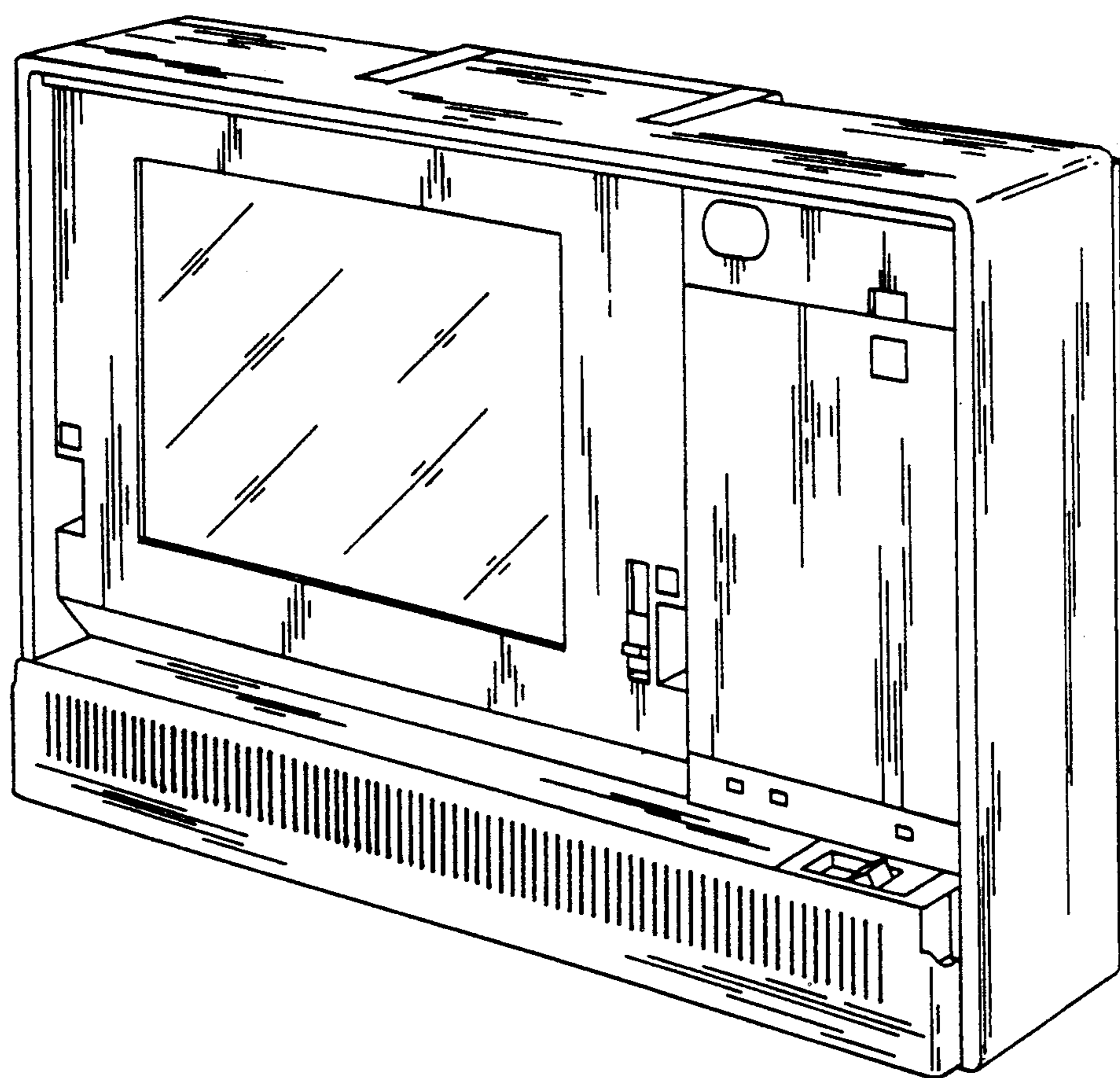

FIG. 2

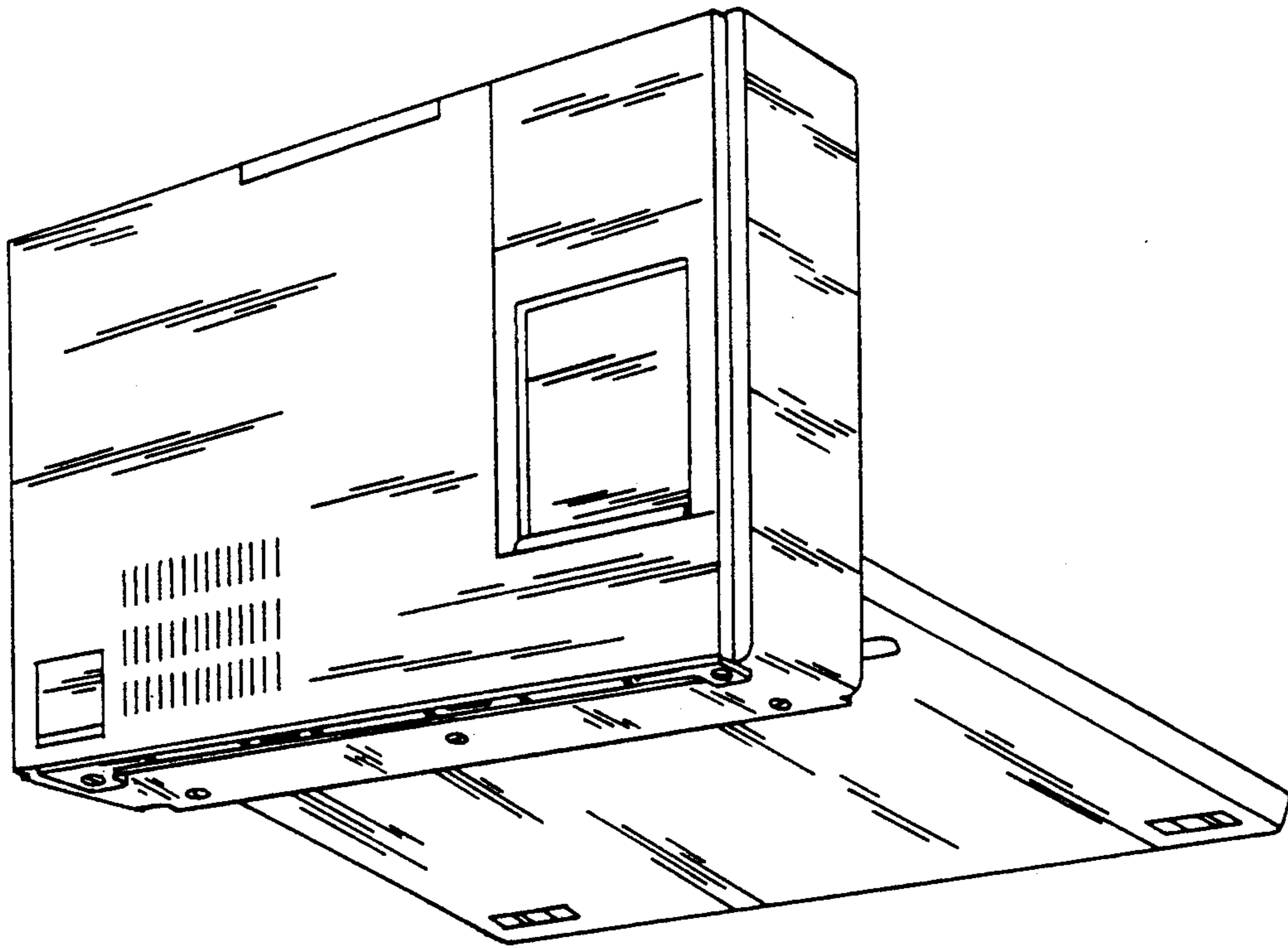

FIG. 3

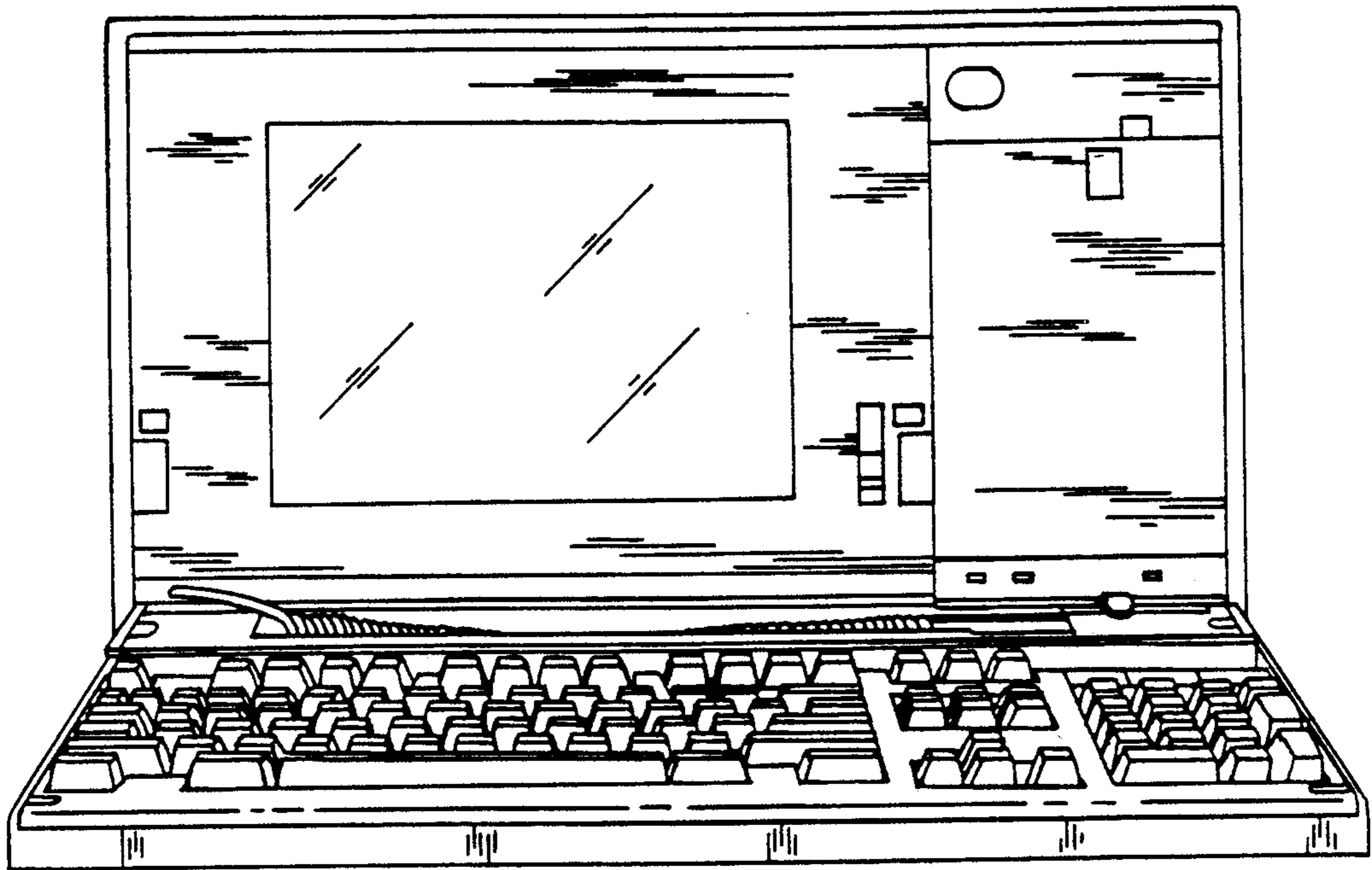

FIG. 4

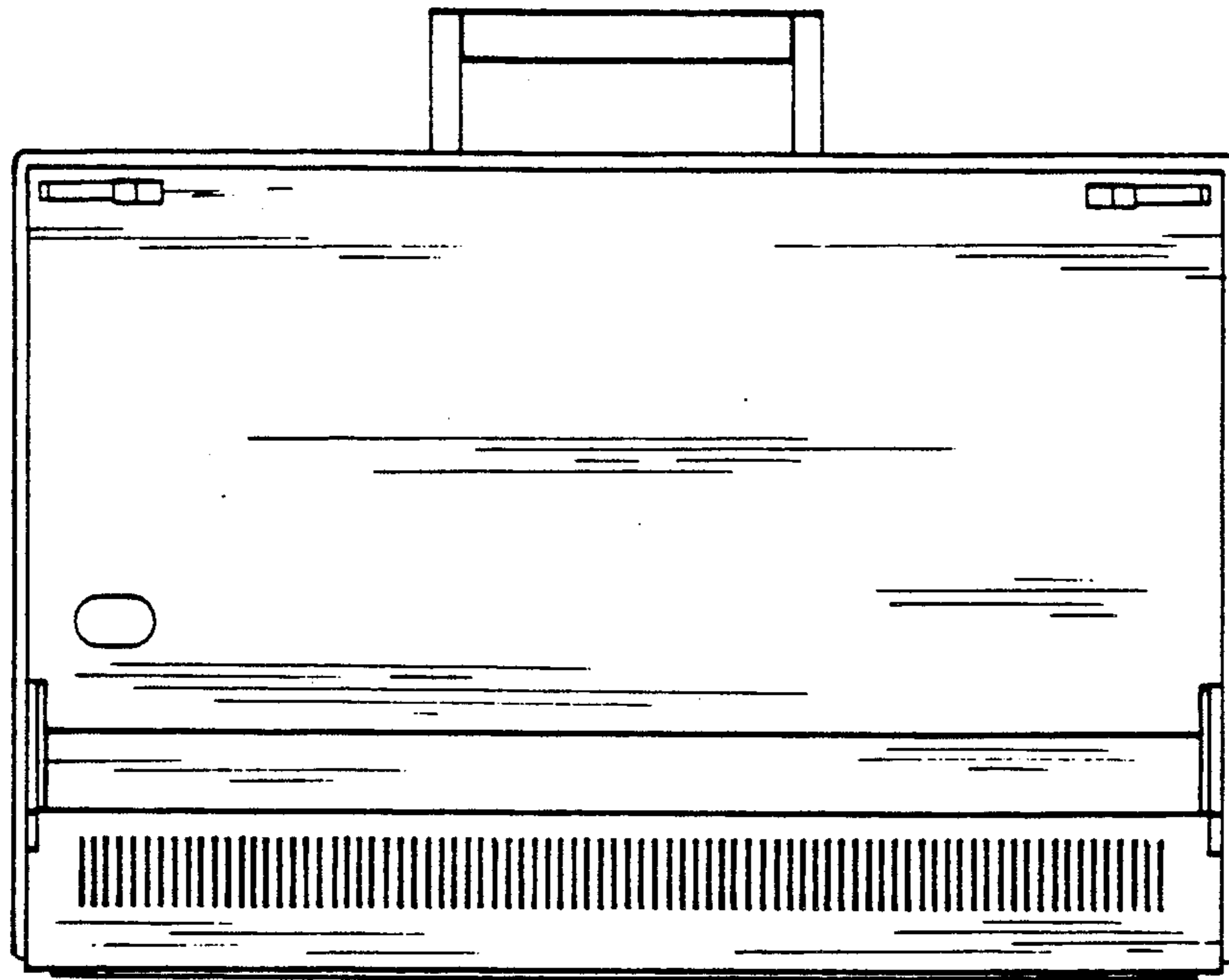

FIG. 5

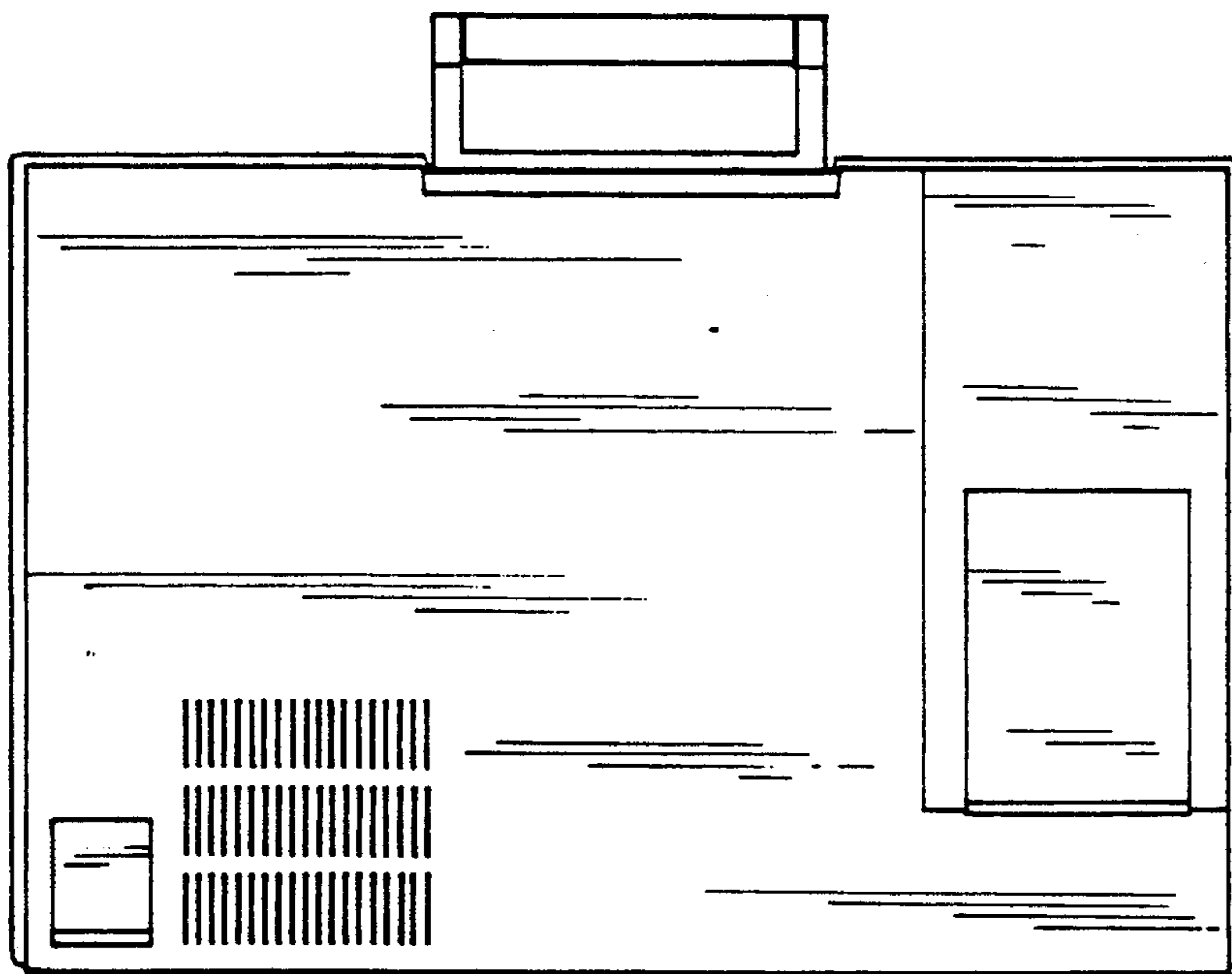

FIG. 6

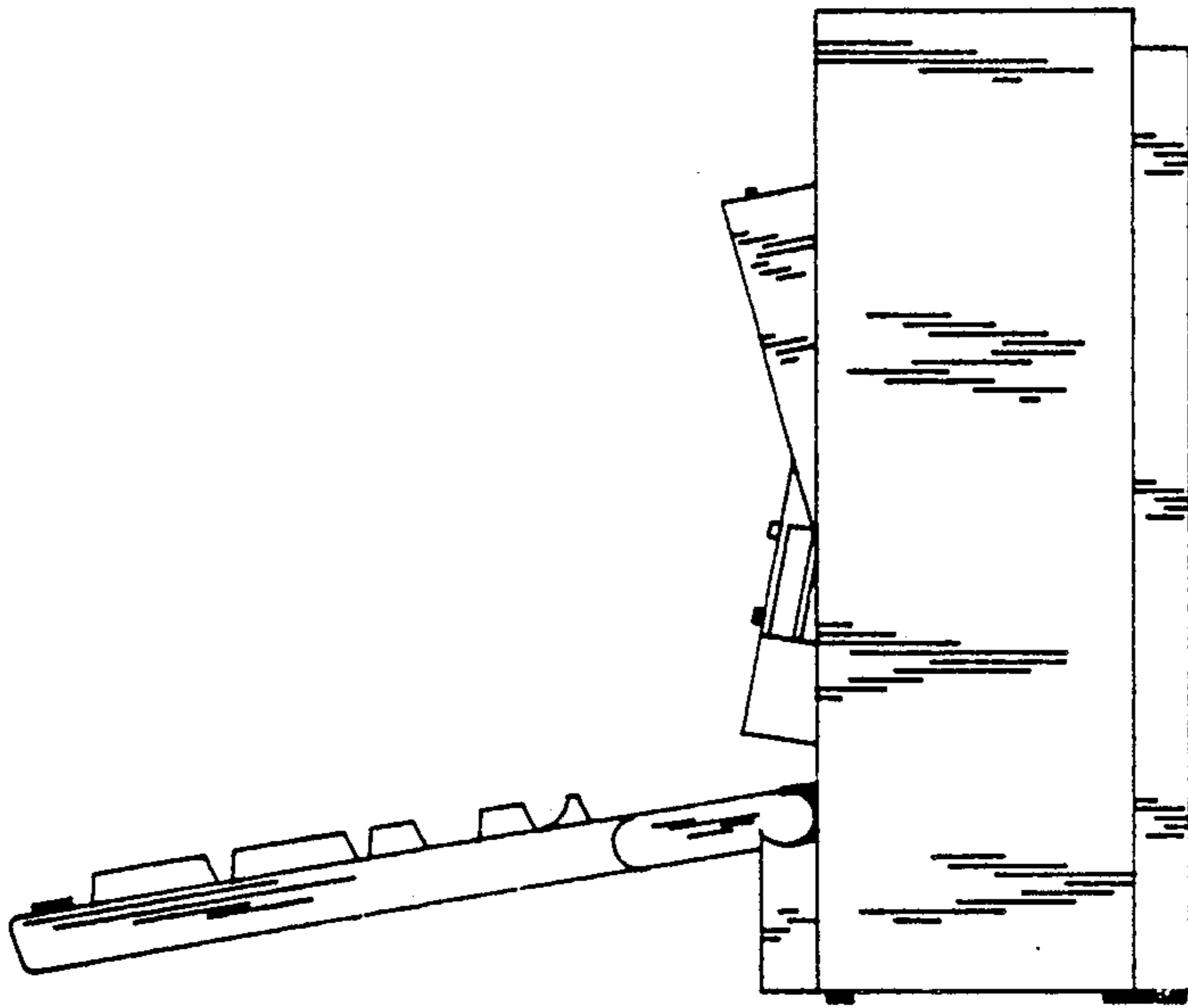

FIG. 7

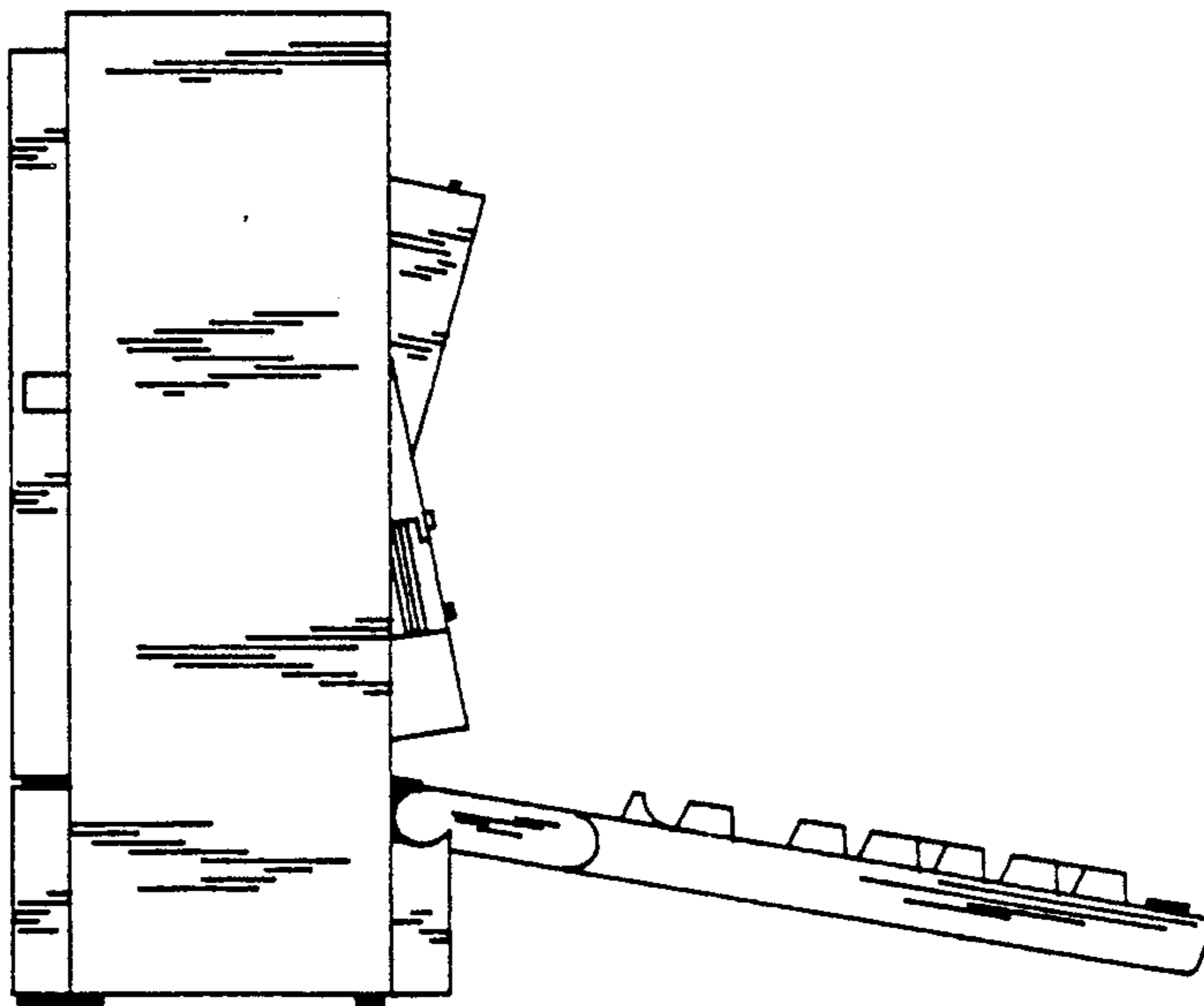

FIG. 8

FIG. 9

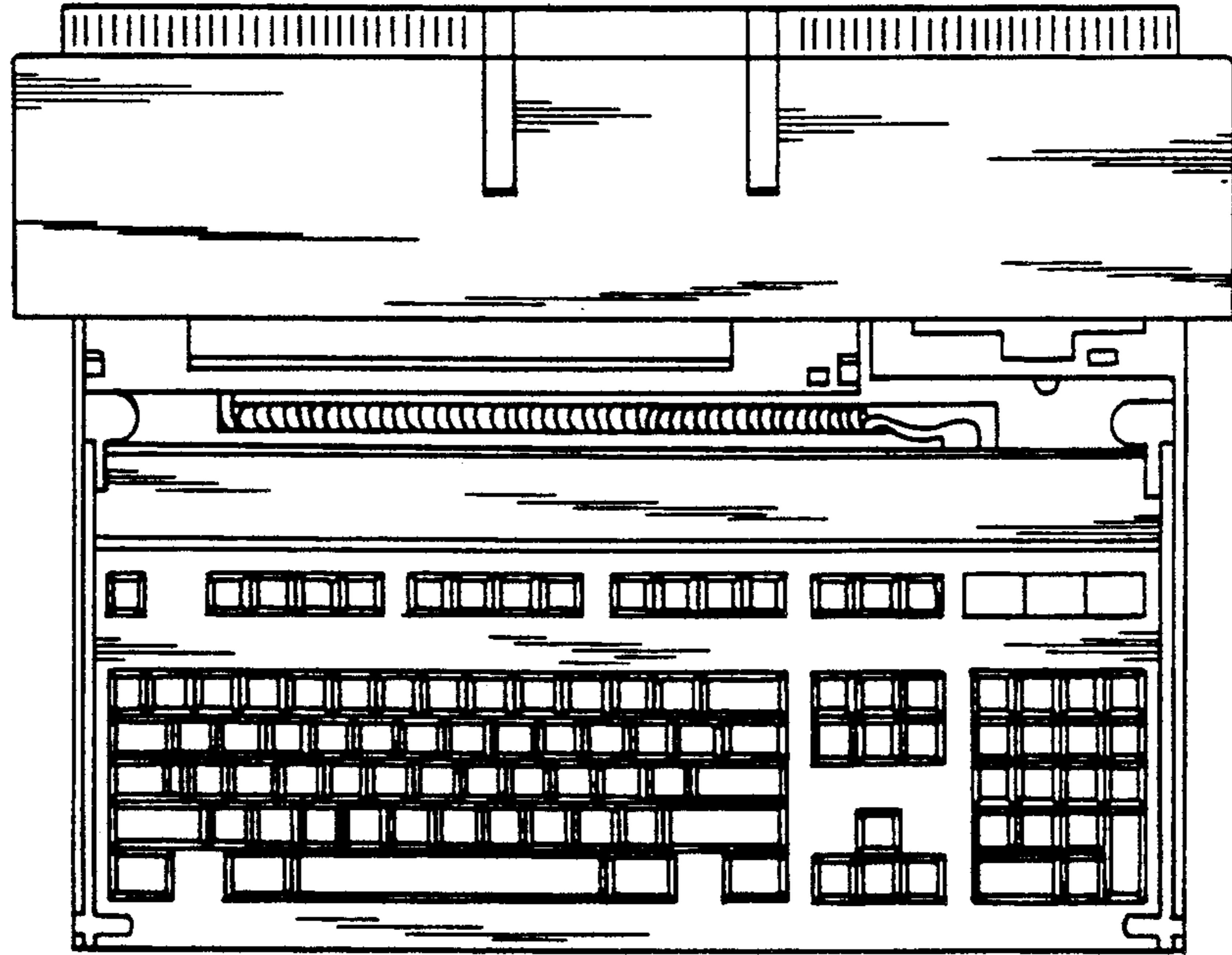
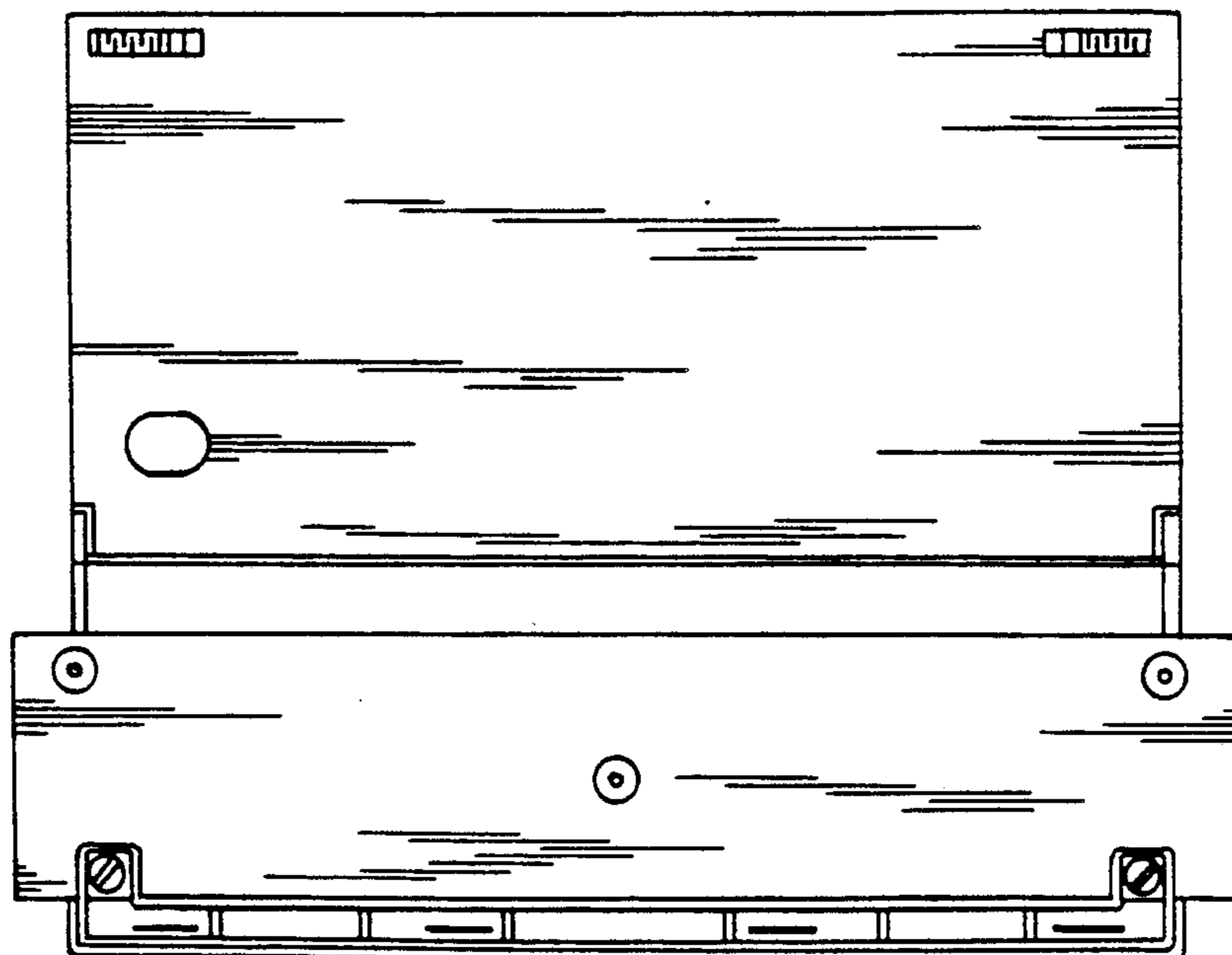

FIG. 10



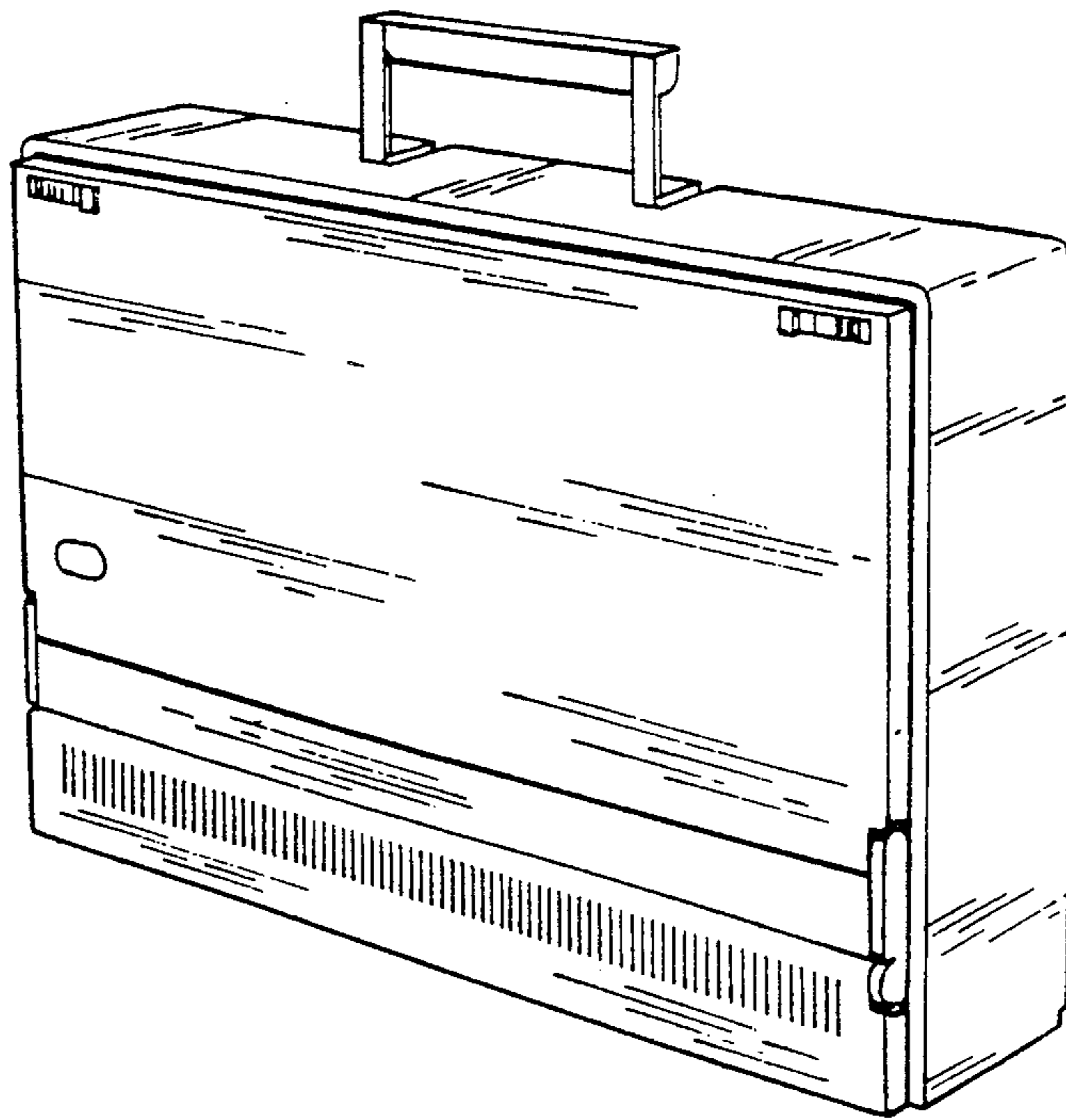

FIG. 11

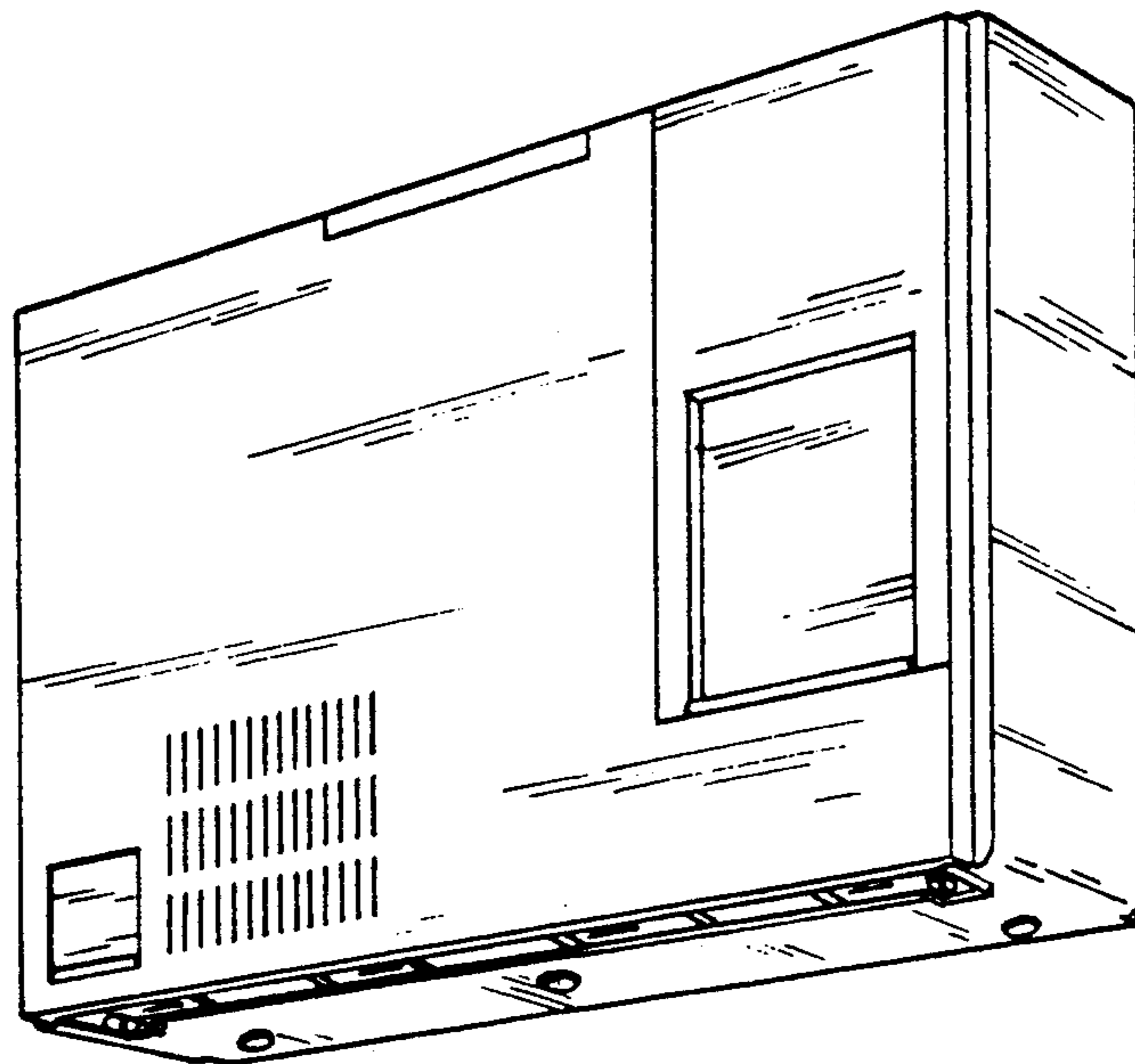

FIG. 12

FIG. 13

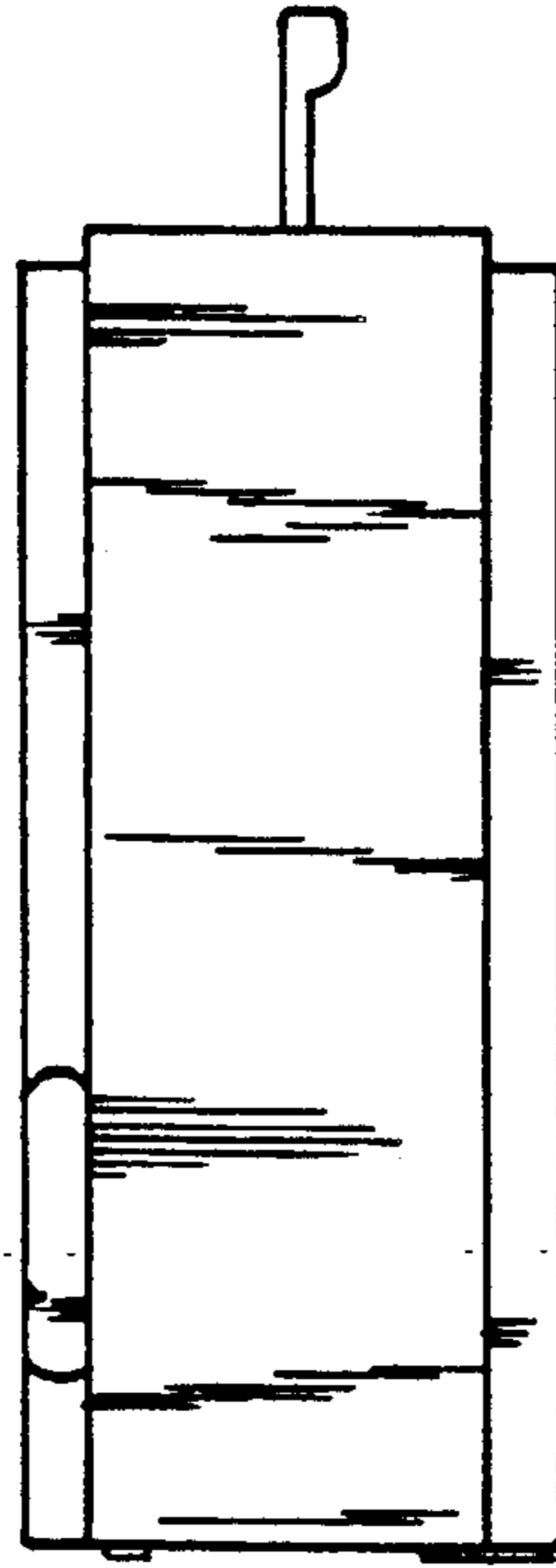
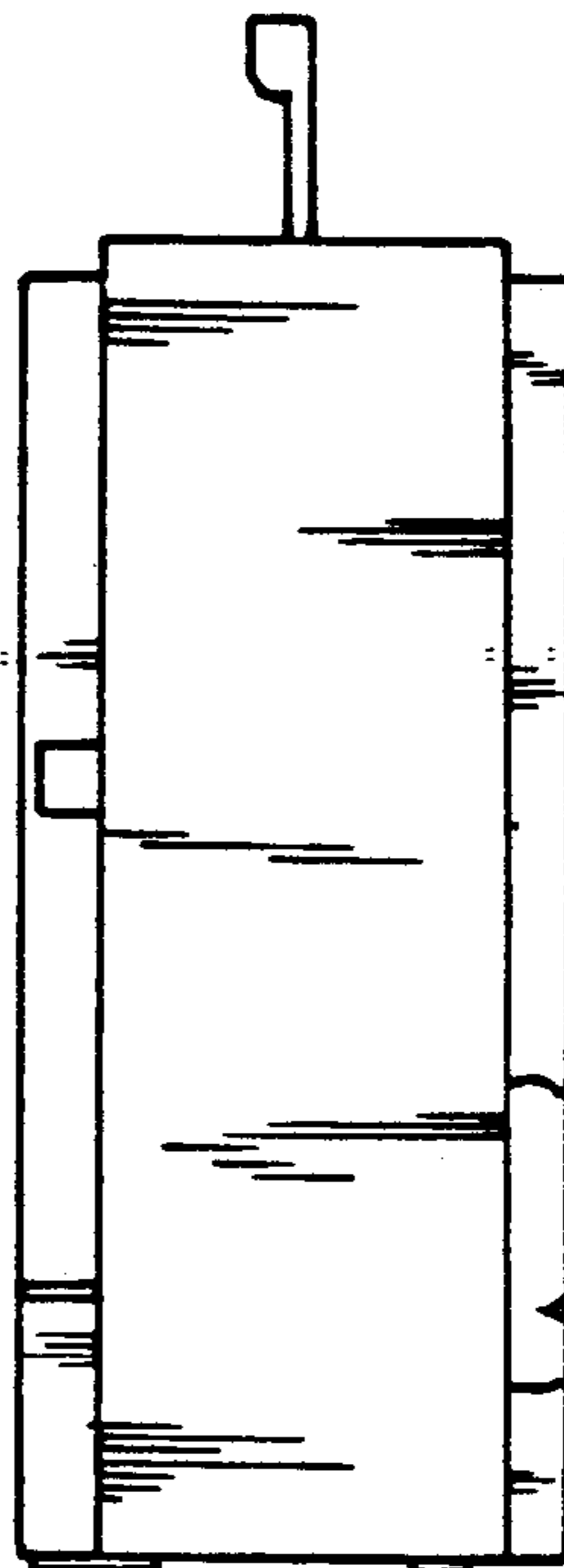

FIG. 14



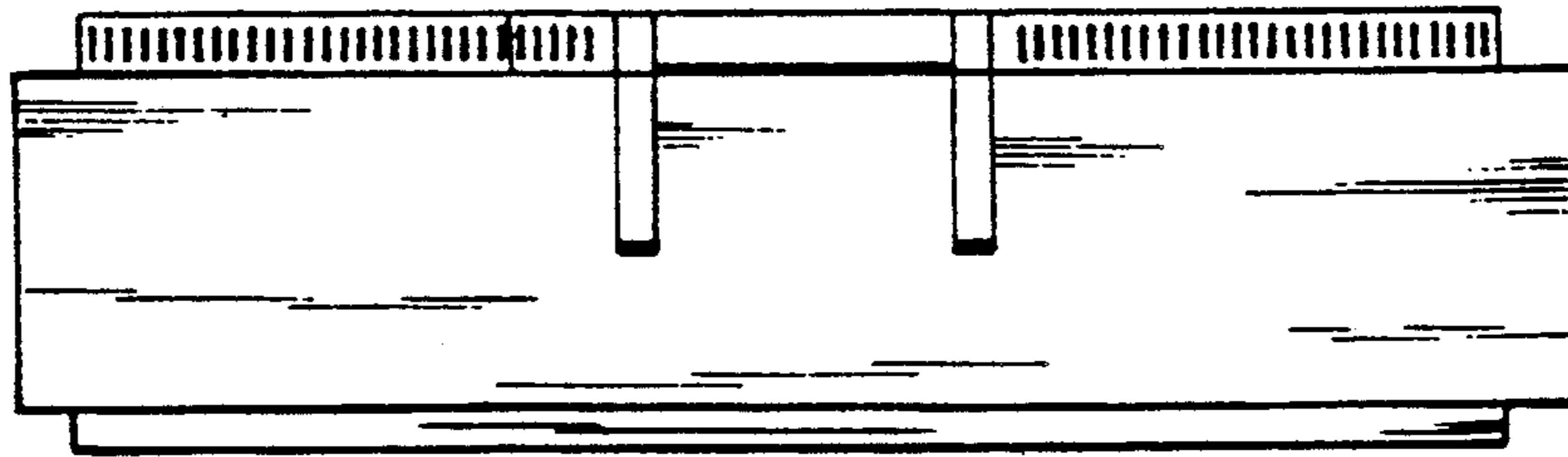

FIG. 15

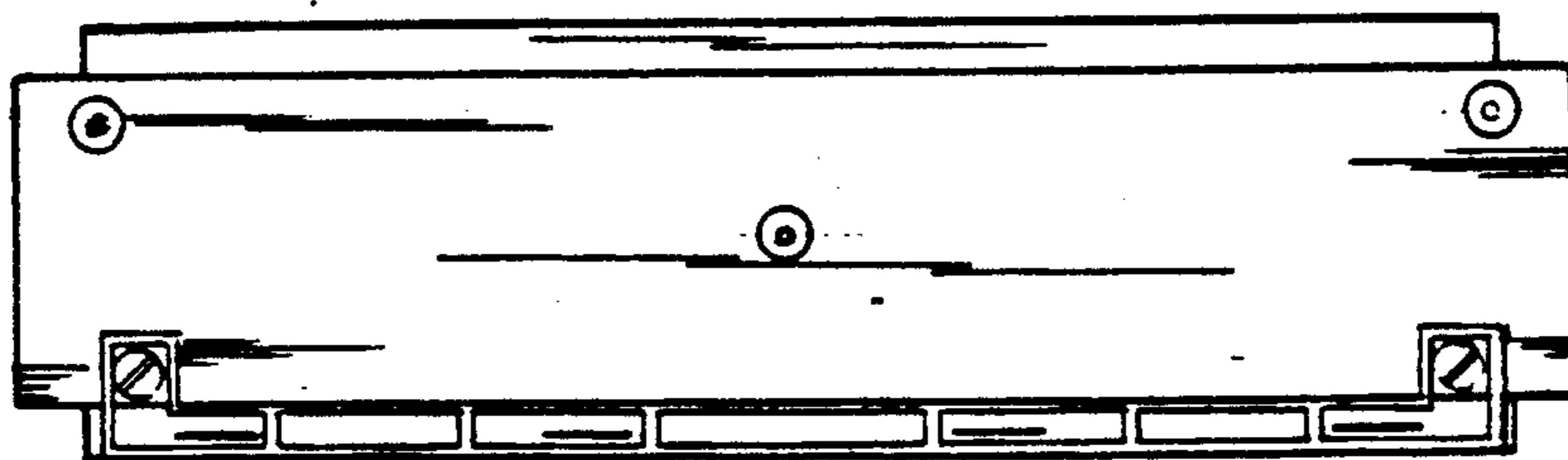

FIG. 16

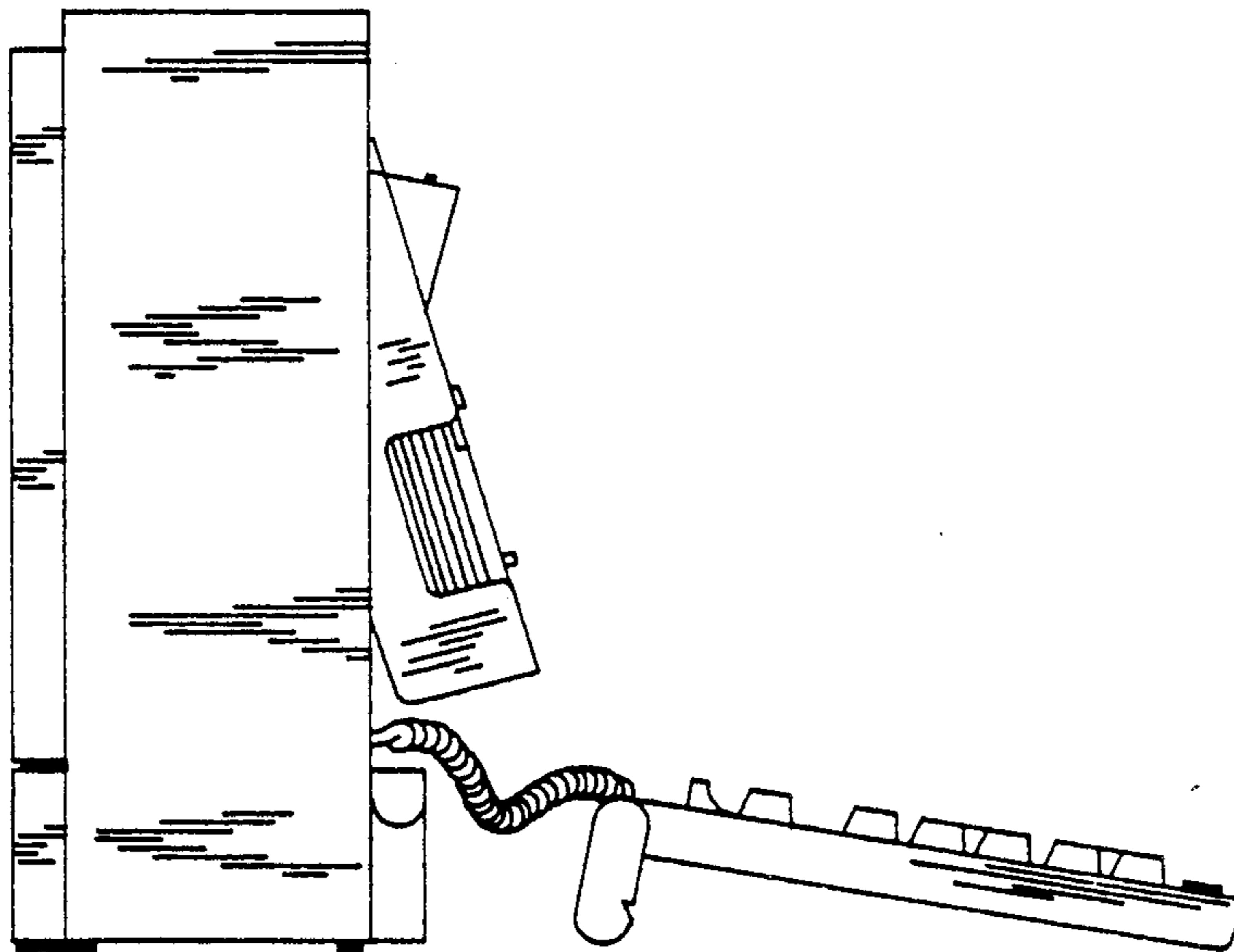

FIG. 17

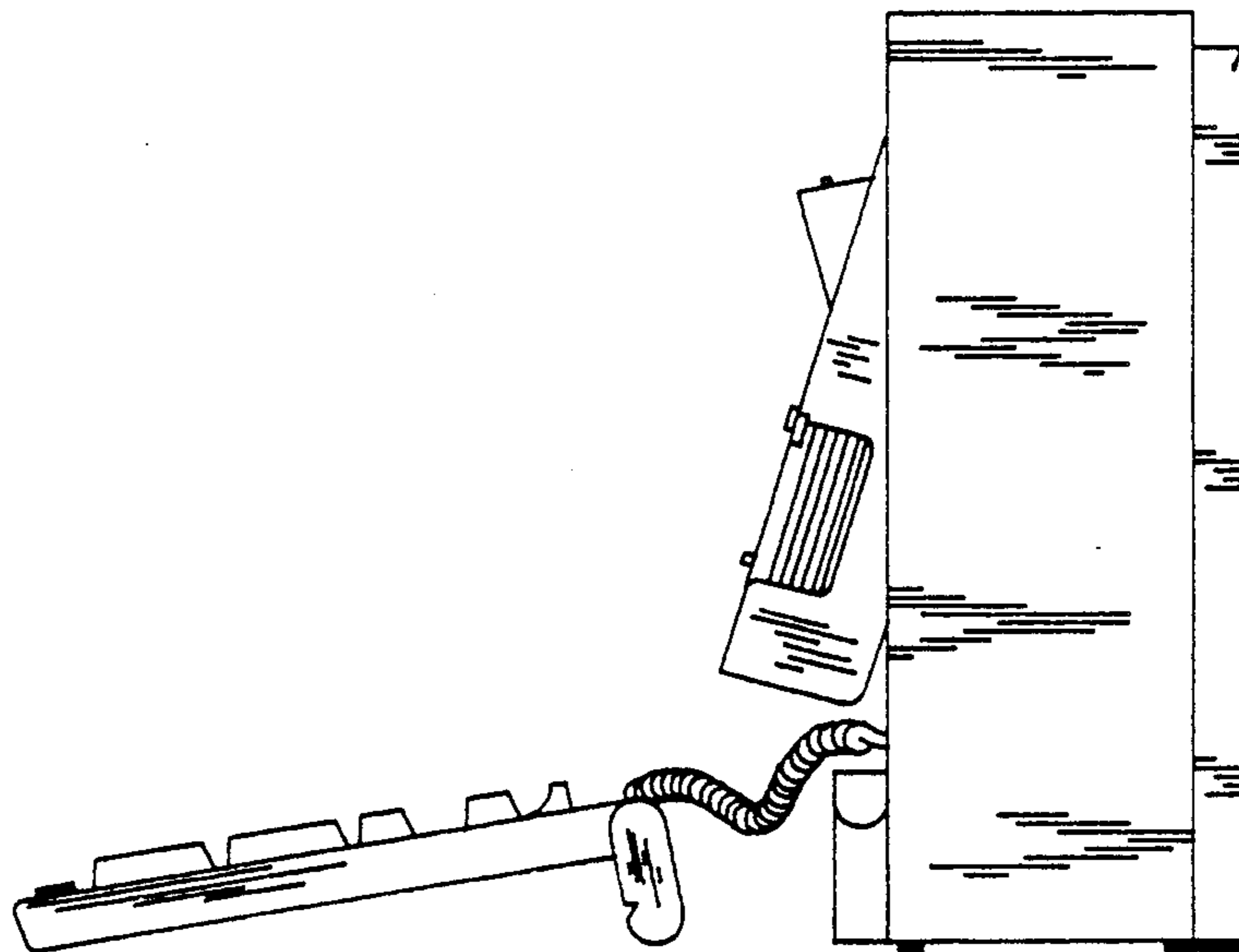

FIG. 18