

[54] SLIDE VIEWER

[76] Inventor: Stephen M. Sherer, 71-519 Biskra Rd., Rancho Mirage, Calif. 92270

[**] Term: 14 Years

[21] Appl. No.: 216,188

[22] Filed: Jul. 7, 1988

[52] U.S. Cl. D16/225

[58] Field of Search D16/221, 222, 229-231, D16/233, 235, 236, 237; 40/361-367; 350/140, 235, 238; 352/129, 242; 353/22-24, 74, 75, 79, 119

[56] References Cited

U.S. PATENT DOCUMENTS

D. 174,119	3/1955	Fuller	D16/227
D. 186,916	12/1959	Close	D16/225
D. 239,874	5/1976	Avery	D16/225
D. 247,497	3/1978	Wolfe	D16/222
D. 251,788	5/1979	Alferow	D16/225
D. 254,010	1/1980	Elsner	D16/227
2,588,803	3/1952	Coffey, Sr.	40/364

OTHER PUBLICATIONS

35 MM Photography, 11/85 p. 4 (Zeiss Ikon Slide Viewer).

Primary Examiner—Bernard Ansher
Assistant Examiner—Adir Aronovich
Attorney, Agent, or Firm—Kelly Bauersfeld & Lowry

[57] CLAIM

The ornamental design for a slide viewer, as shown and described.

DESCRIPTION

FIG. 1 is a front right side perspective view of a slide viewer showing my new design;
FIG. 2 is front elevation view thereof;
FIG. 3 is a right side elevation view thereof;
FIG. 4 is a left side elevation view thereof;
FIG. 5 is a rear elevation view thereof;
FIG. 6 is a top plan view thereof;
FIG. 7 is a bottom plan view thereof; and
FIG. 8 is a front right side perspective view; with the support arm in an extended position.

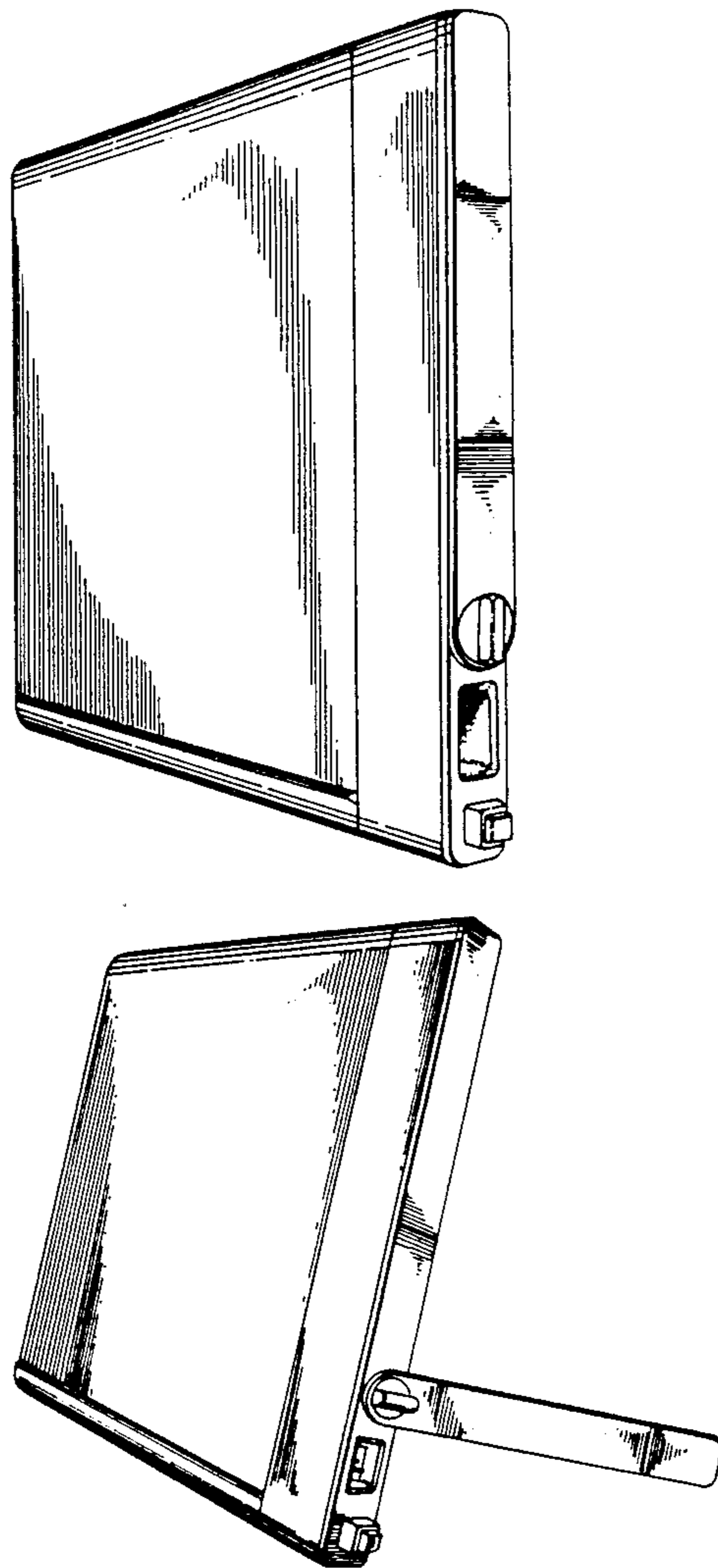

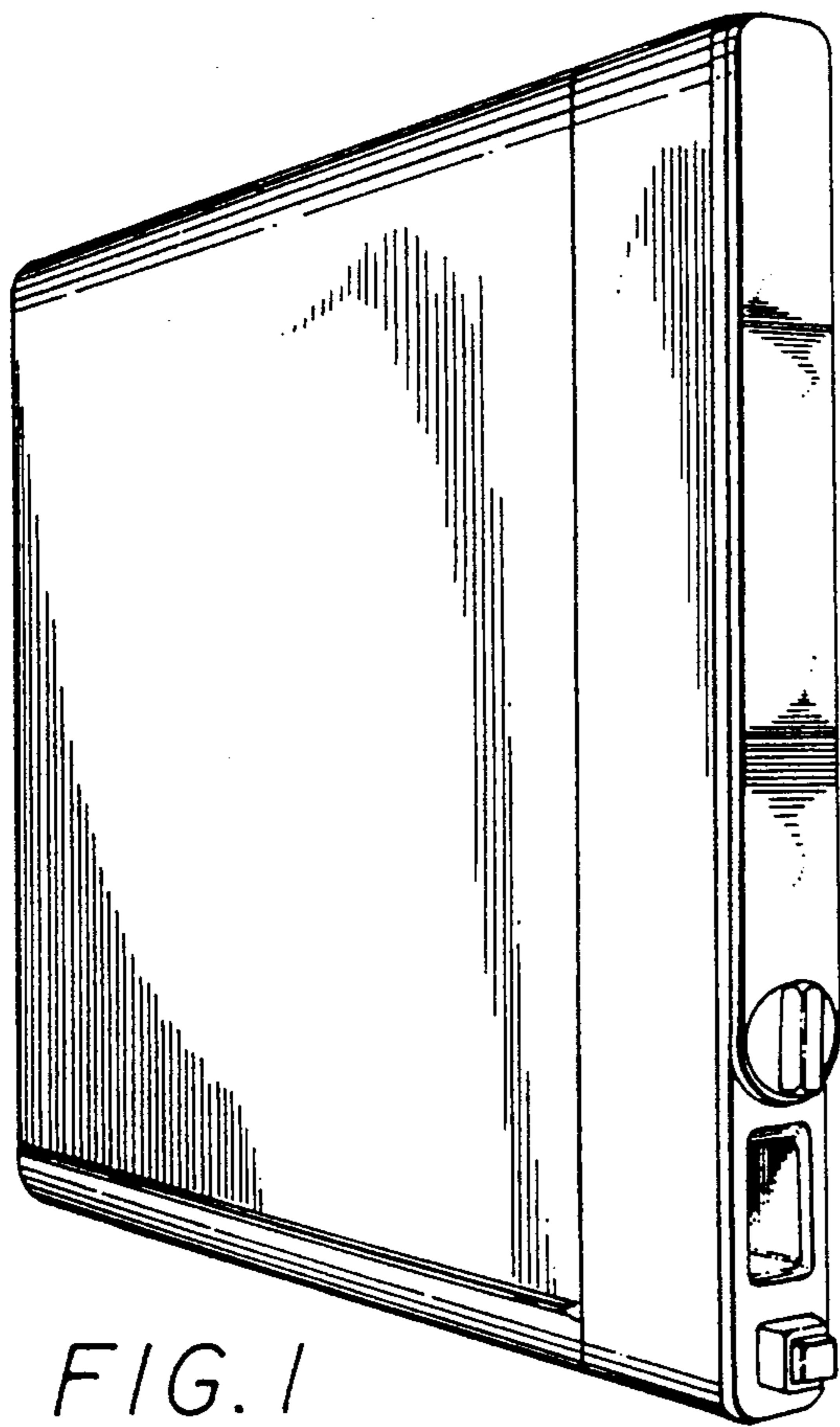

FIG. 1

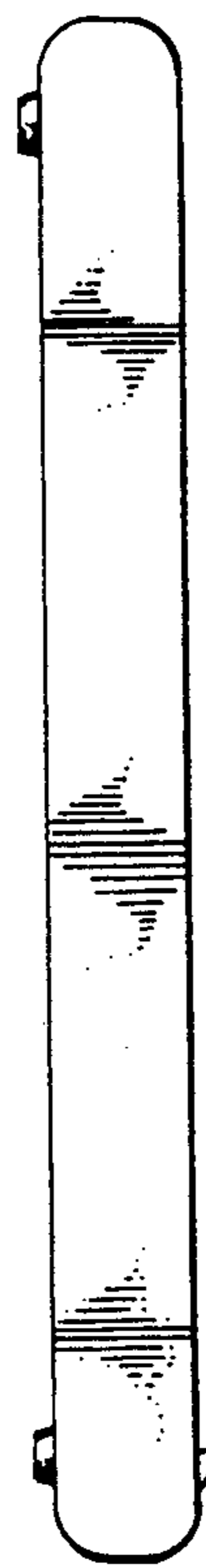

FIG. 3



FIG. 4

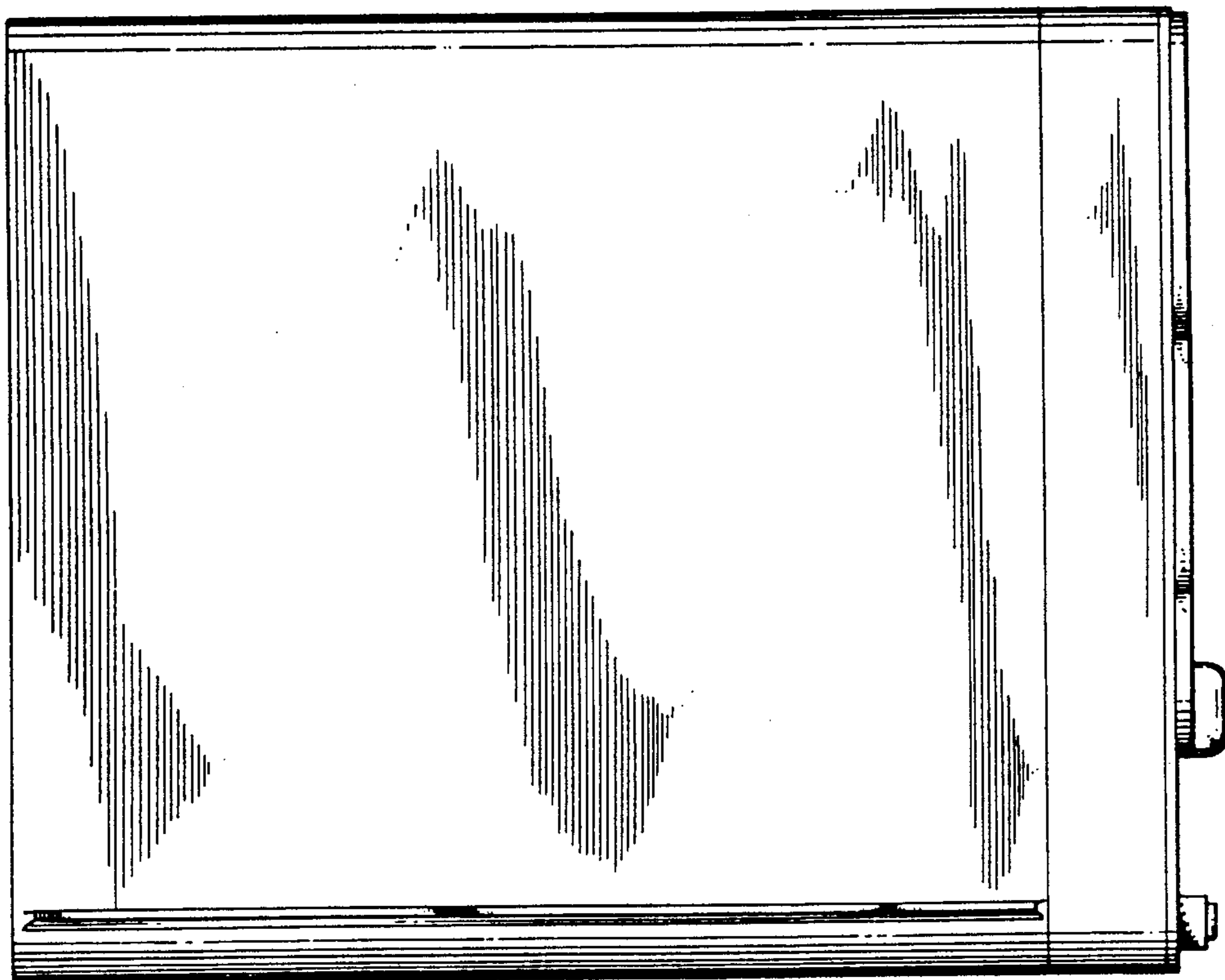

FIG. 2

FIG. 5

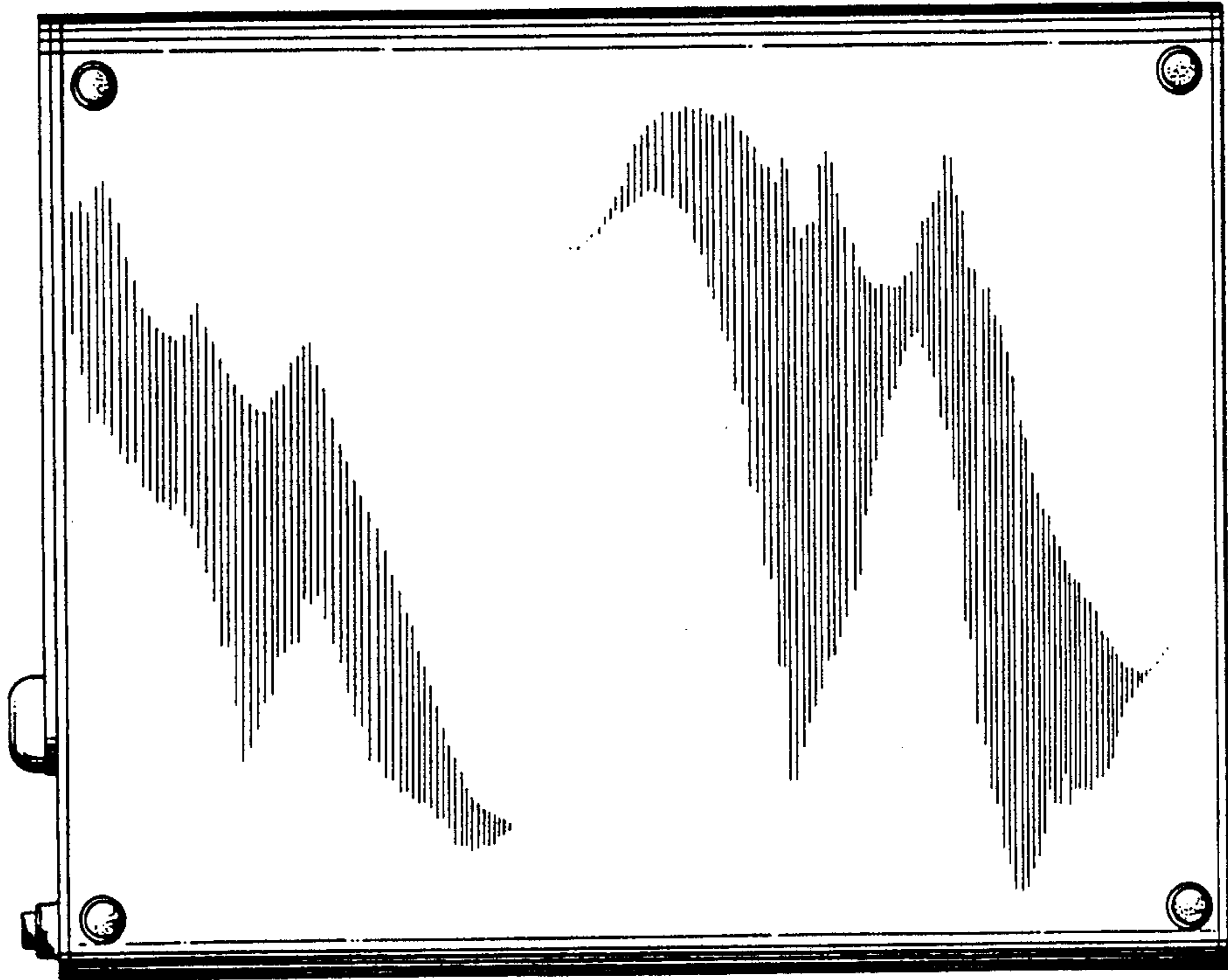

FIG. 6

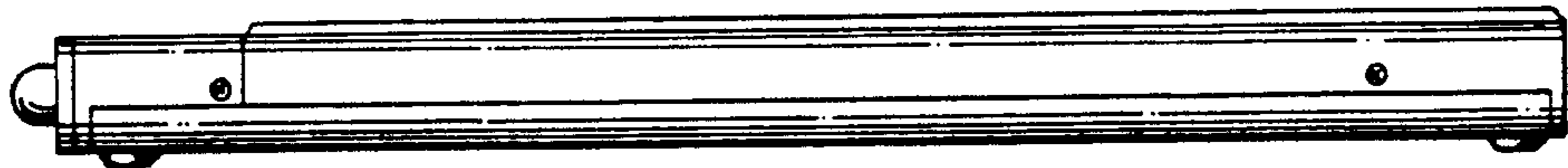

FIG. 7

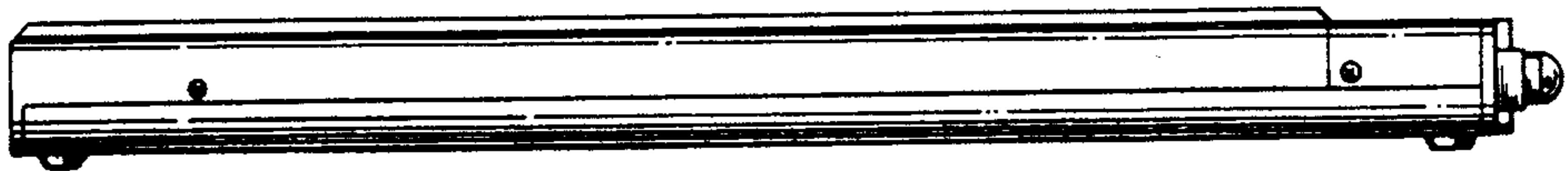

FIG. 8

