

[54] PATIENT COVER SUPPORT
[76] Inventor: Nancy Elliott, P.O. Box 265,
Eatonville, Wash. 98328
[**] Term: 14 Years
[21] Appl. No.: 280,287
[22] Filed: Dec. 5, 1988
[52] U.S. Cl. D6/607
[58] Field of Search D6/607, 610;
5/503-505

4,802,252 2/1989 Marmor 5/505

Primary Examiner—Wallace R. Burke
Assistant Examiner—Brian N. Vinson
Attorney, Agent, or Firm—Leon Gilden

[57] CLAIM

The ornamental design for a patient cover support, as shown and described.

DESCRIPTION

FIG. 1 is a front elevational view of a patient cover support showing my new design; FIG. 2 is a rear elevational view thereof; FIG. 3 is a left side elevational view thereof; FIG. 4 is a right side elevational view thereof; FIG. 5 is a top plan view thereof; FIG. 6 is a bottom plan view thereof; and FIG. 7 is a perspective view thereof.

[56] References Cited
U.S. PATENT DOCUMENTS

2,783,482	3/1957	Schmidt et al.	5/505
3,680,158	8/1972	Speed	5/505
3,798,685	3/1974	Hunt et al.	5/505
4,570,275	2/1986	Merriman	5/505

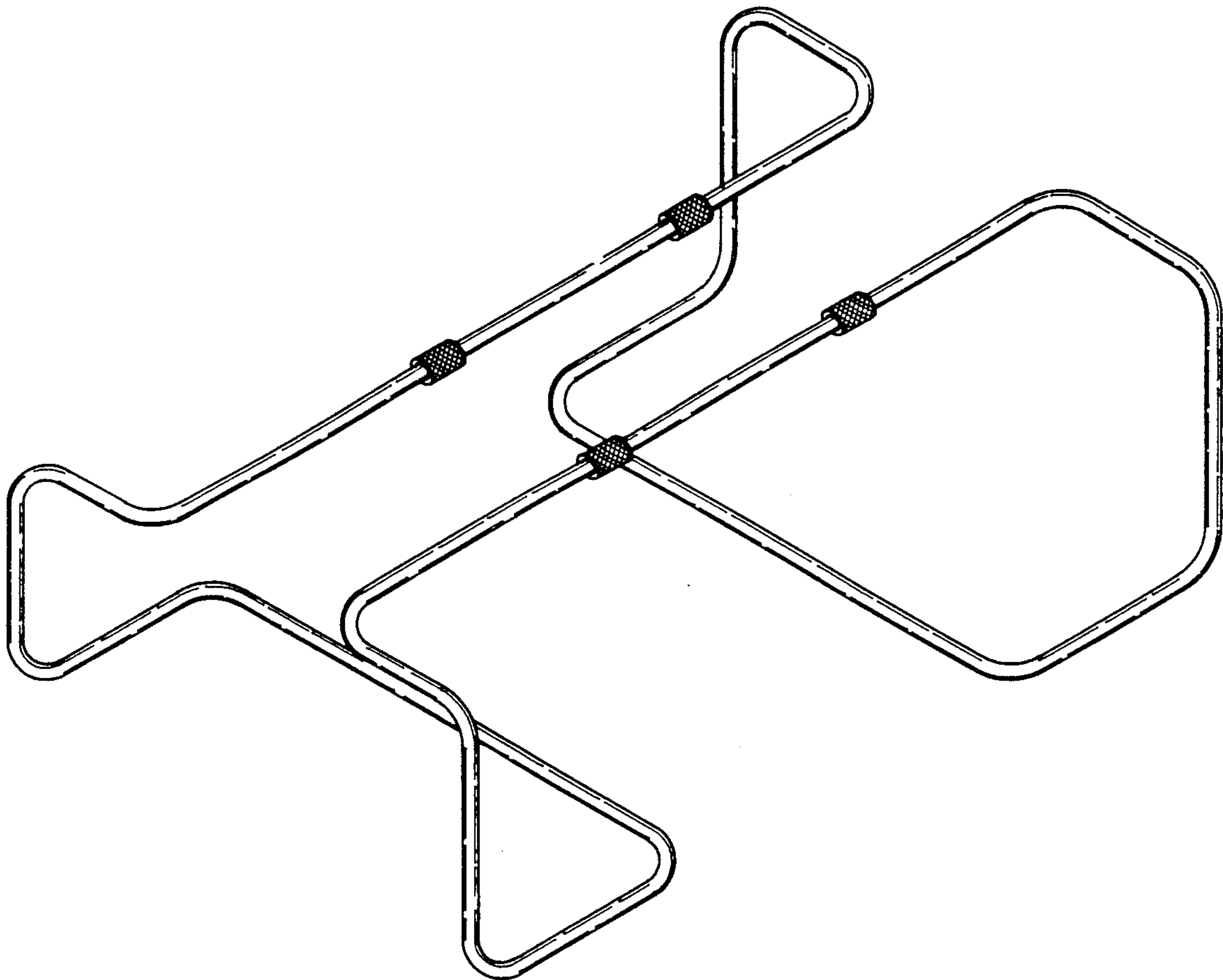

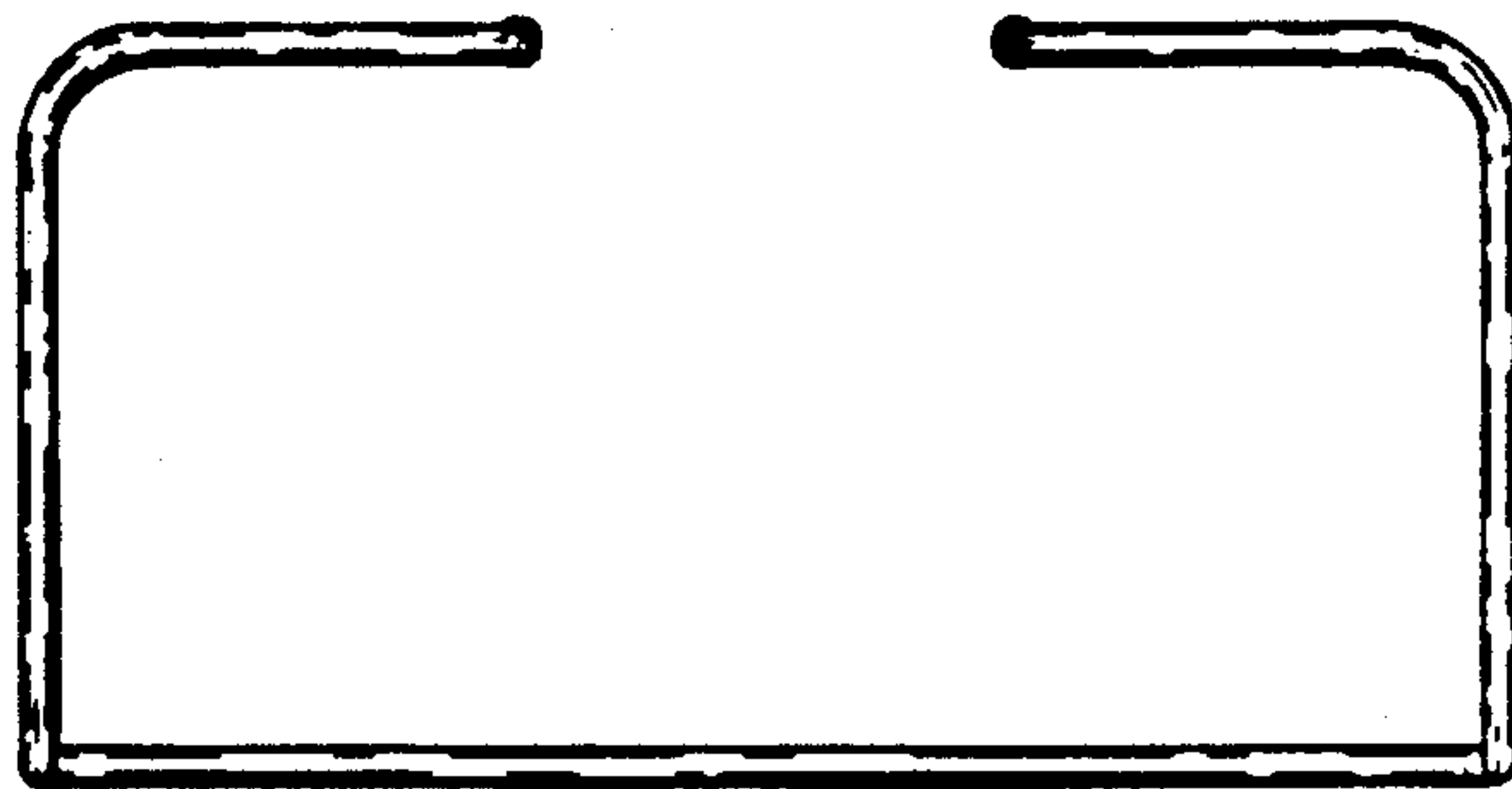

FIG. 1.

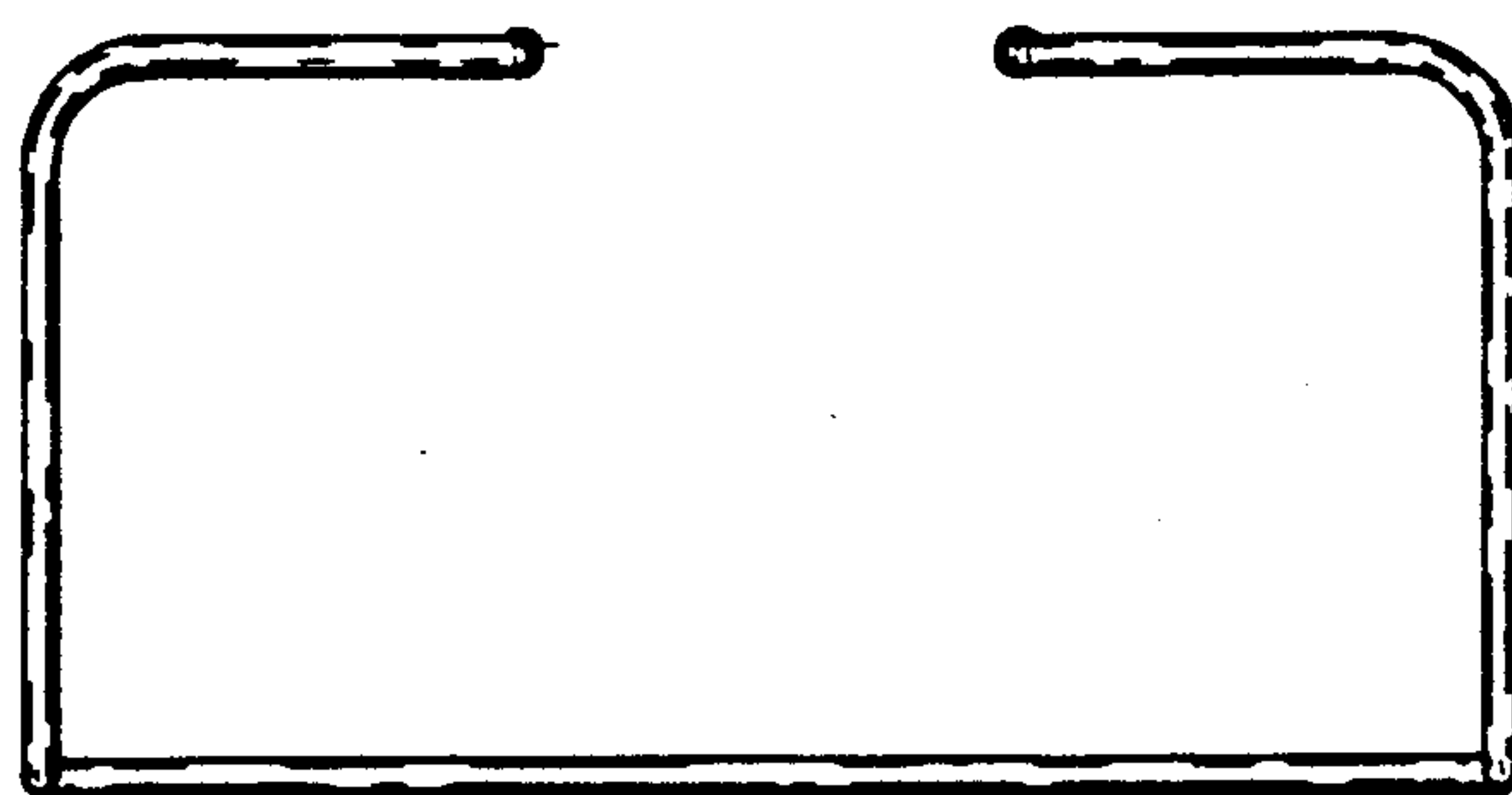

FIG. 2.

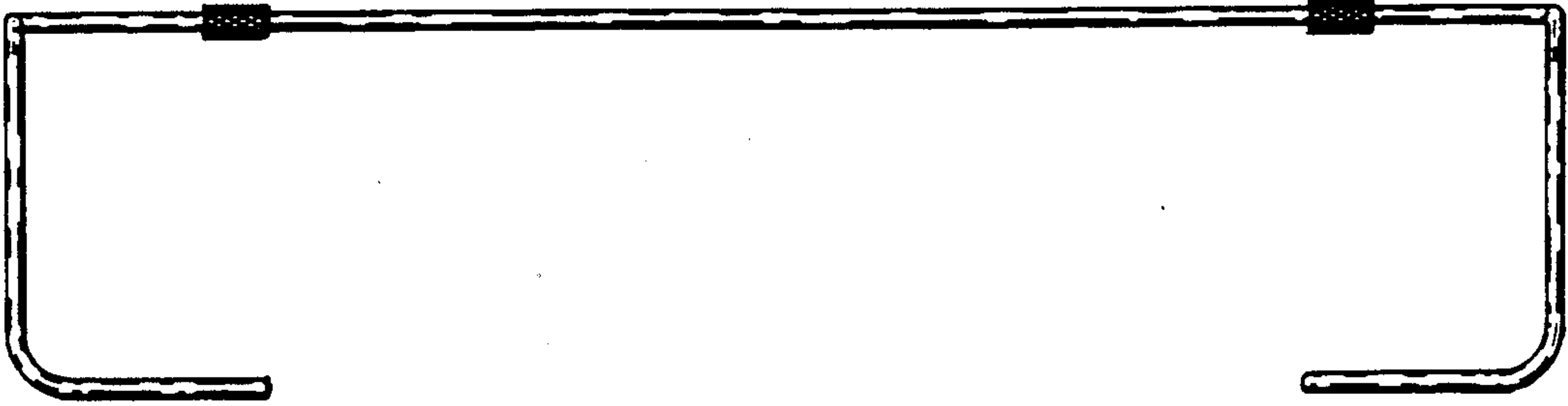

FIG. 3.

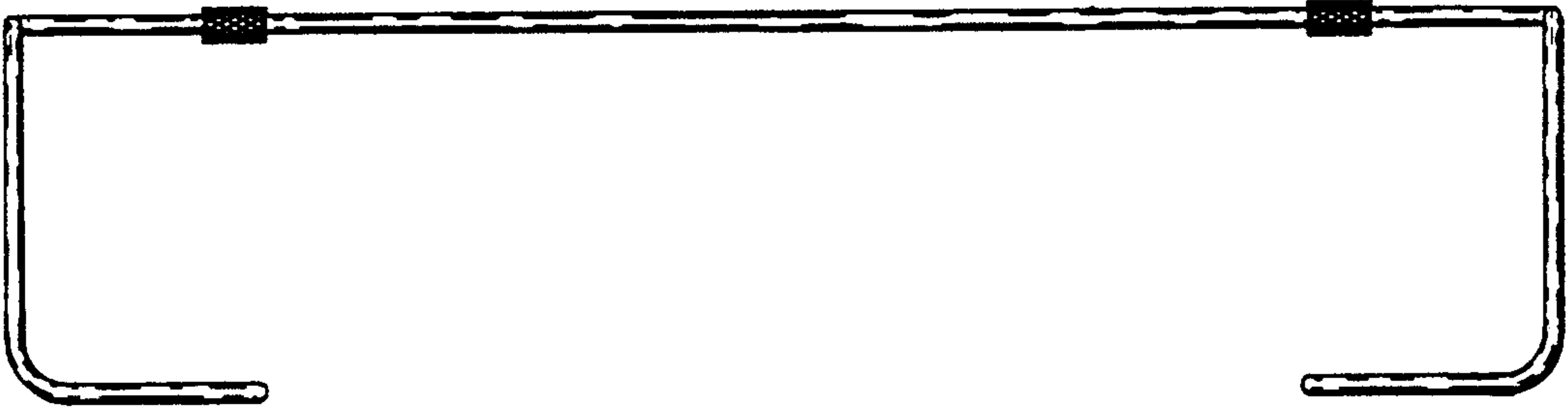

FIG. 4.

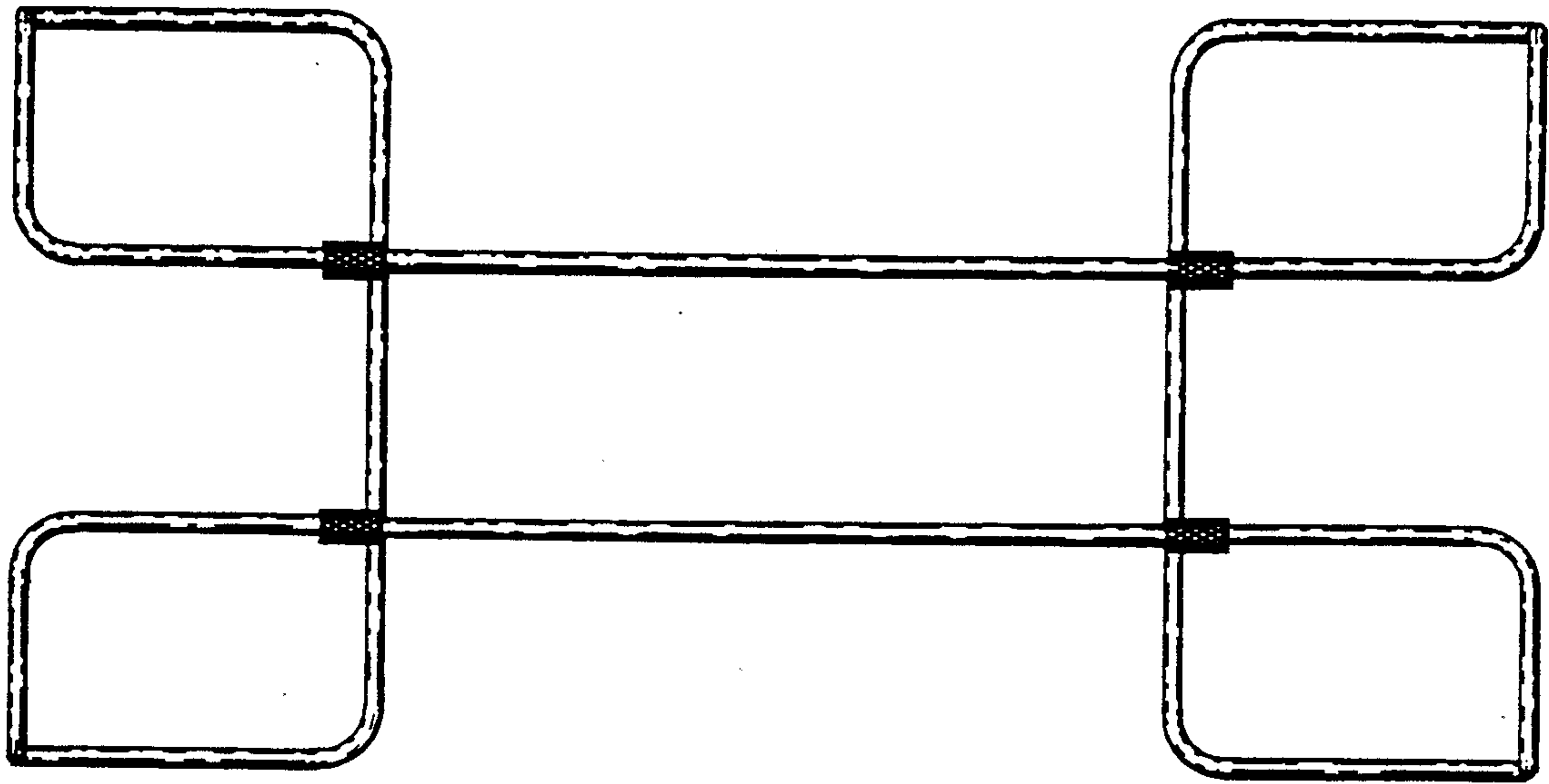

FIG. 5.

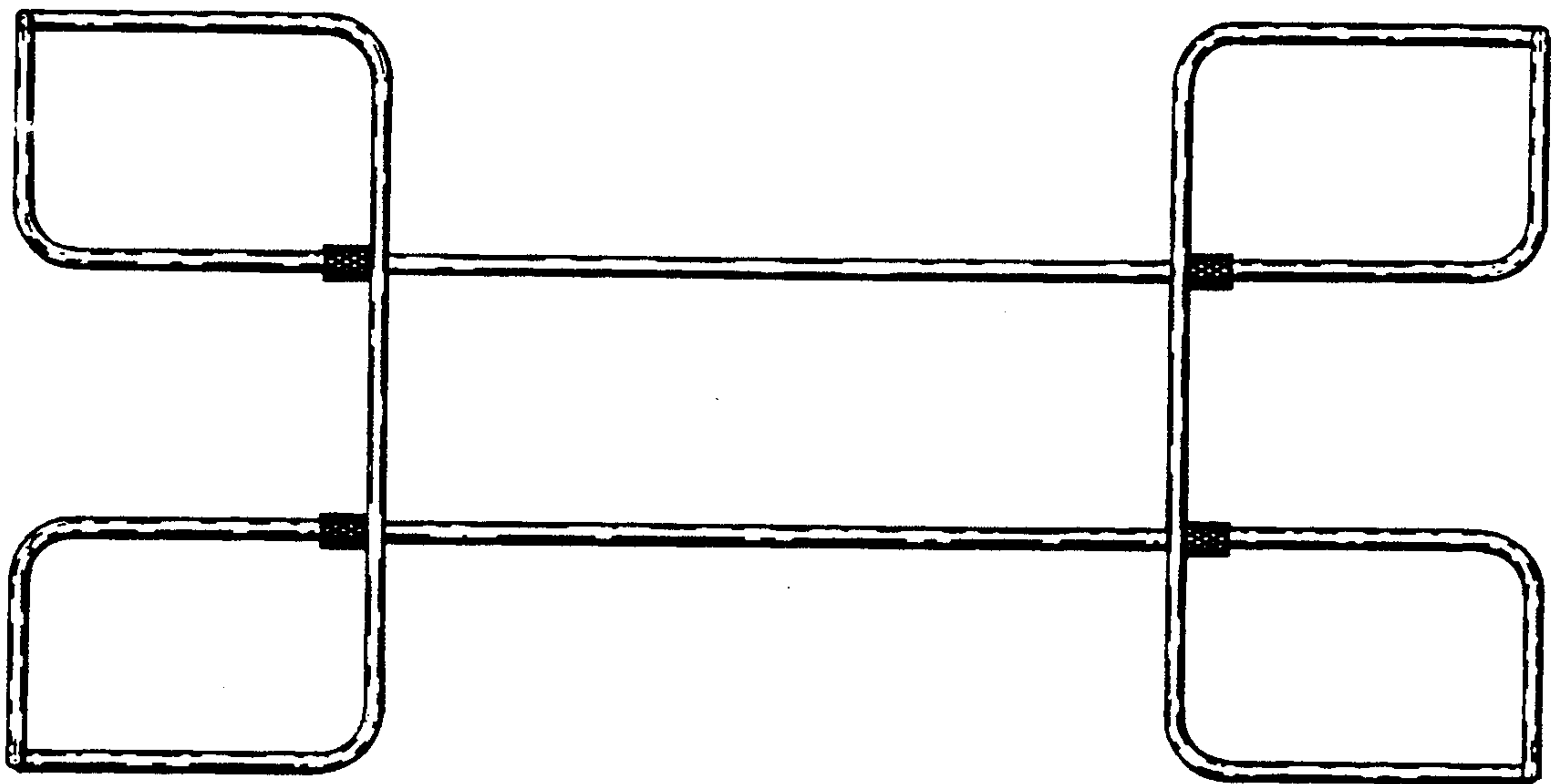

FIG. 6.

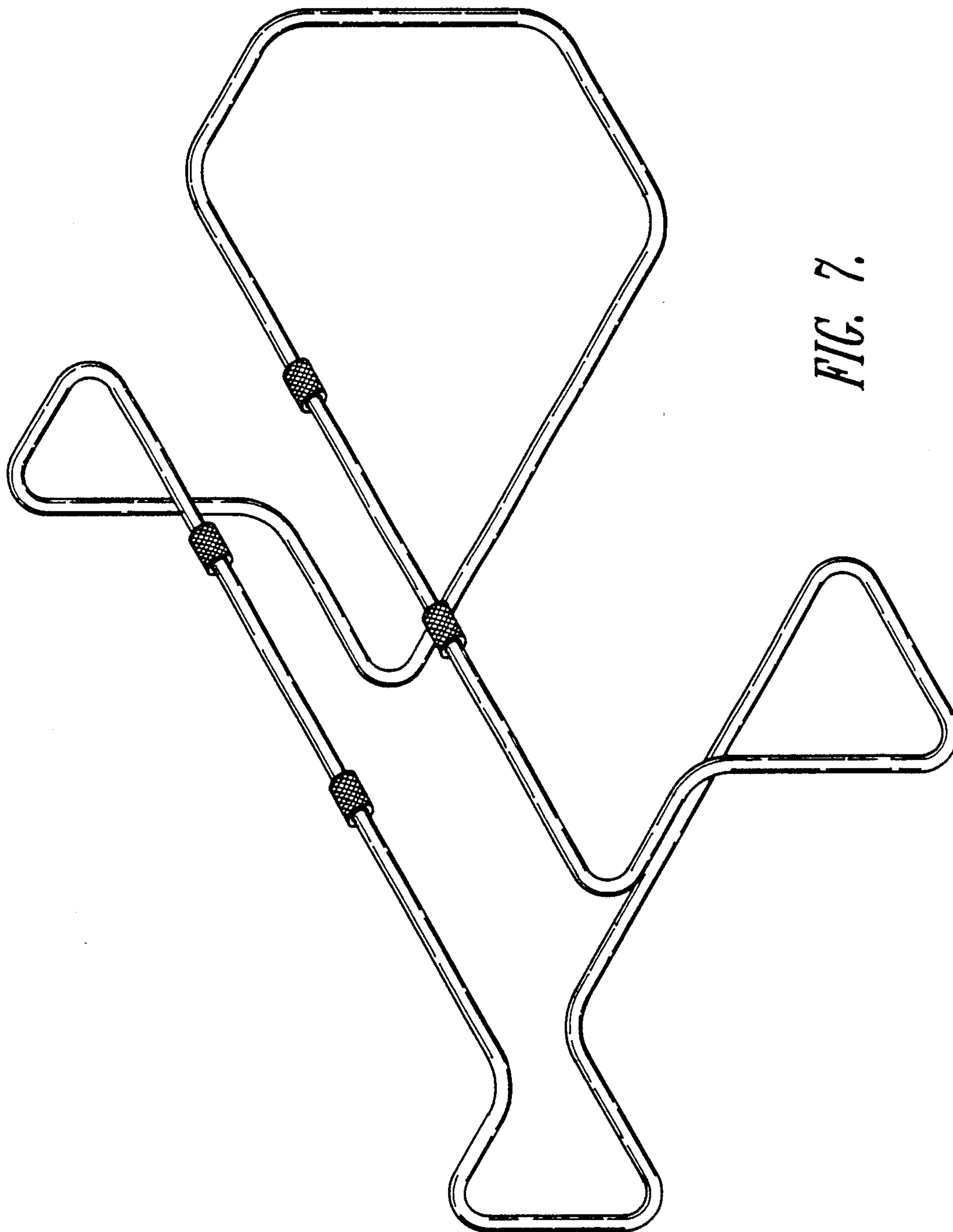

FIG. 7.