

# United States Patent [19]

Garza

[11] Patent Number: Des. 315,457

[45] Date of Patent: \*\* Mar. 19, 1991

[54] WRITING DESK

[76] Inventor: David J. Garza, 124 Fifth St., Clovis, Calif. 93612

[\*\*] Term: 14 Years

[21] Appl. No.: 239,329

[22] Filed: Sep. 1, 1988

[52] U.S. Cl. .... D6/428

[58] Field of Search ..... D6/420, 421, 422-428, D6/480-484; 312/194-196; 108/59, 60

[56] **References Cited**

**U.S. PATENT DOCUMENTS**

D. 151,287	10/1948	Sanders	.....	D6/425
D. 161,361	12/1950	Moore	.....	D6/426
D. 223,371	4/1972	Allen	.....	D6/422
D. 234,661	4/1975	Ball	.....	D6/428

D. 296,054	6/1988	Connell et al.	.....	D6/480 X
D. 303,464	9/1989	Holl	.....	D6/426

*Primary Examiner*—Carmen H. Vales-Lado  
*Attorney, Agent, or Firm*—Worrel & Worrel

[57] **CLAIM**

The ornamental design for a writing desk, as shown and described.

**DESCRIPTION**

FIG. 1 is a rear perspective view of the writing desk showing my new design.

FIG. 2 is a front perspective view thereof.

FIG. 3 is a top plan view thereof.

FIG. 4 is a bottom plan view thereof.

FIG. 5 is a rear elevational view thereof.

FIG. 6 is a front elevational view thereof.

FIG. 7 is a left side elevational view thereof; and

FIG. 8 is a right side elevational view thereof.

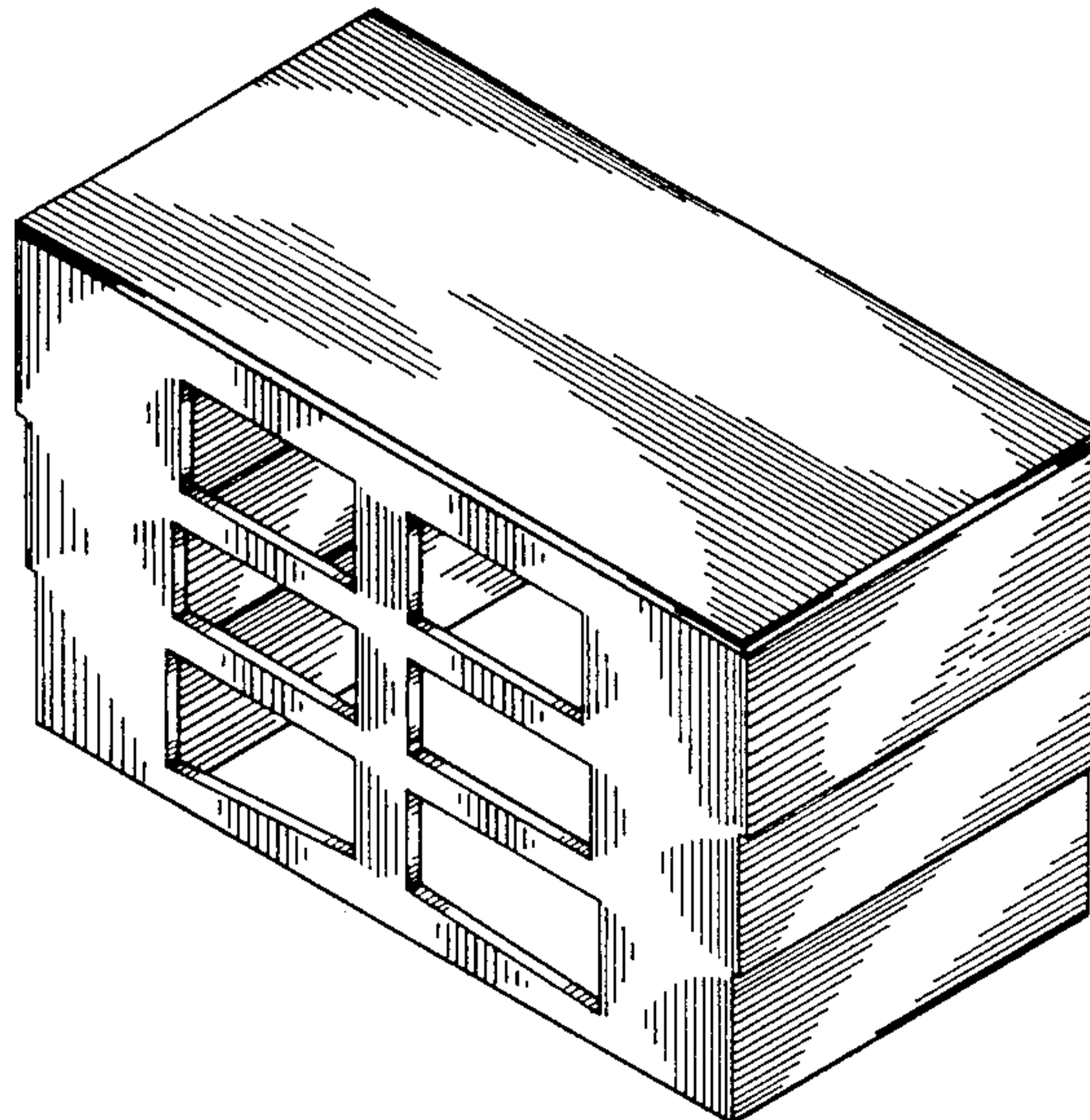
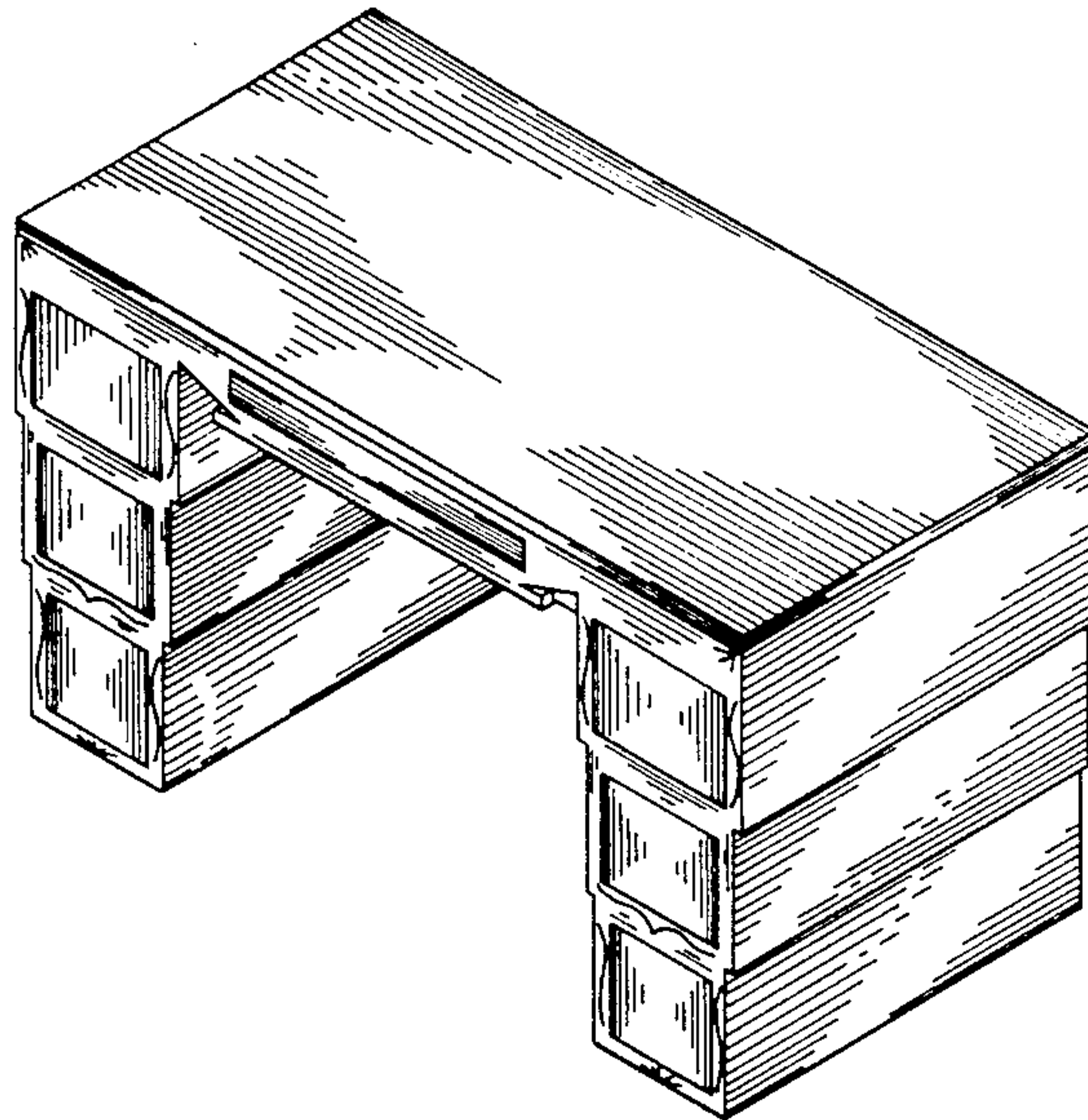

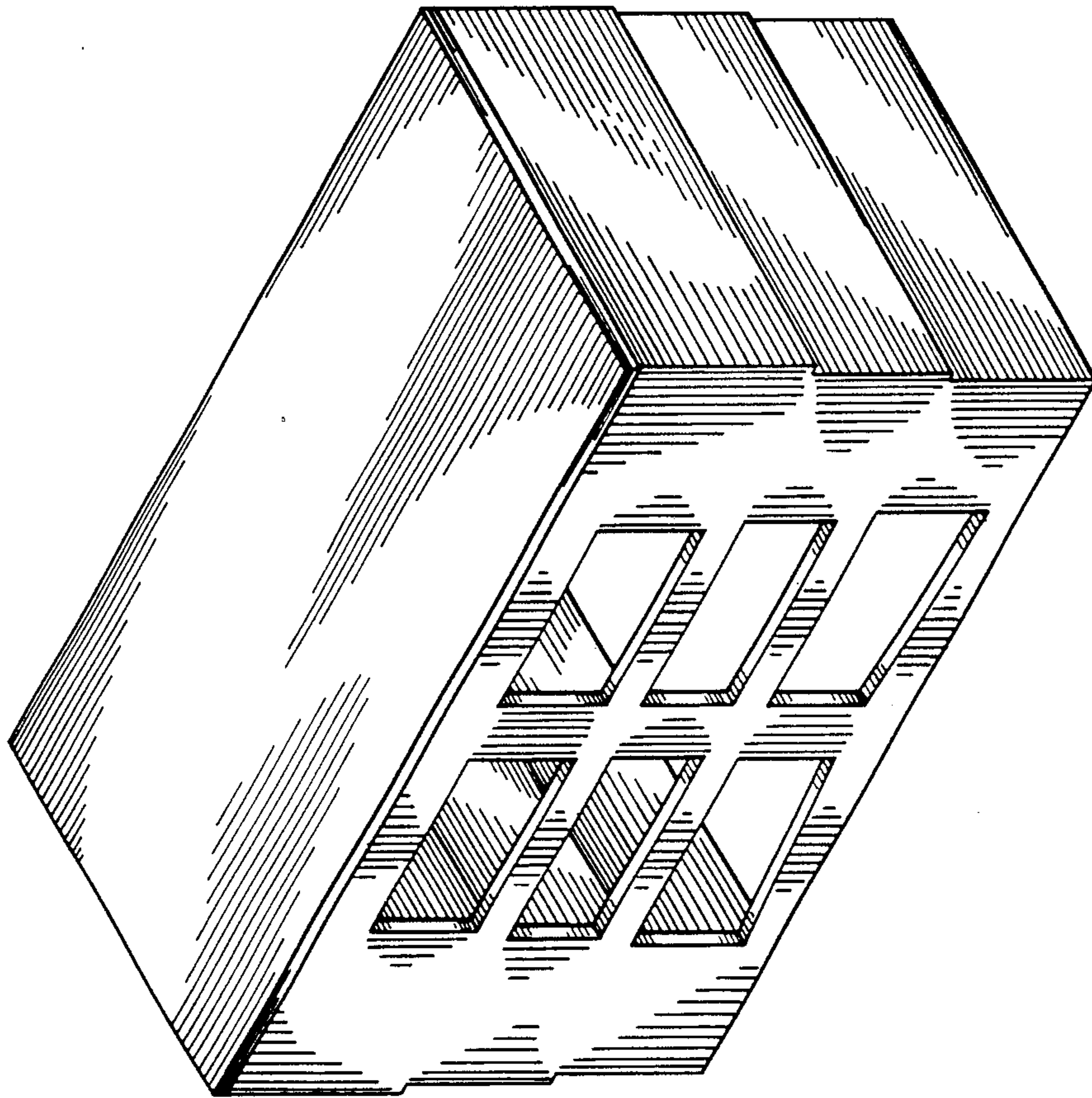

FIG. 2

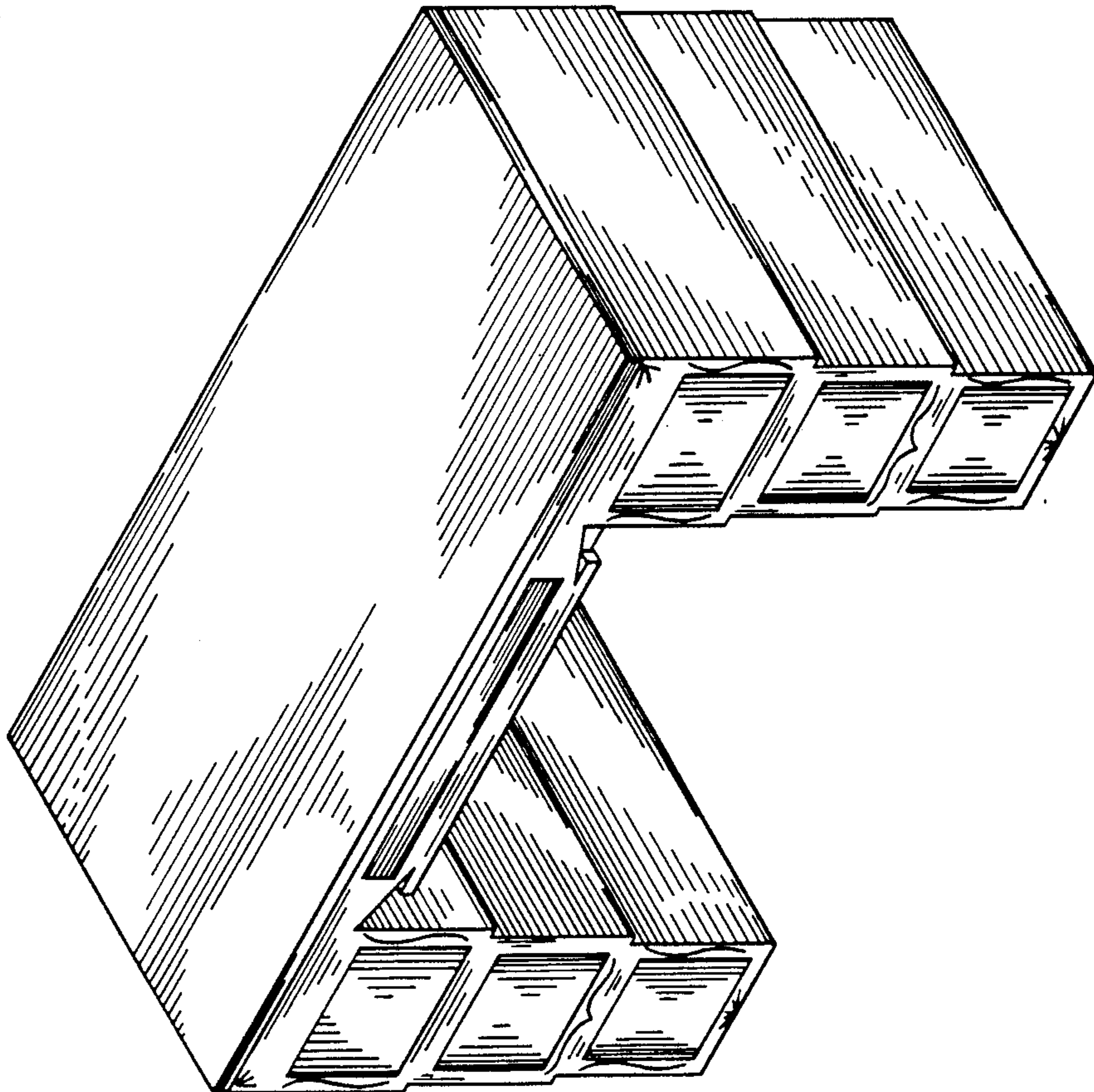

FIG. 1



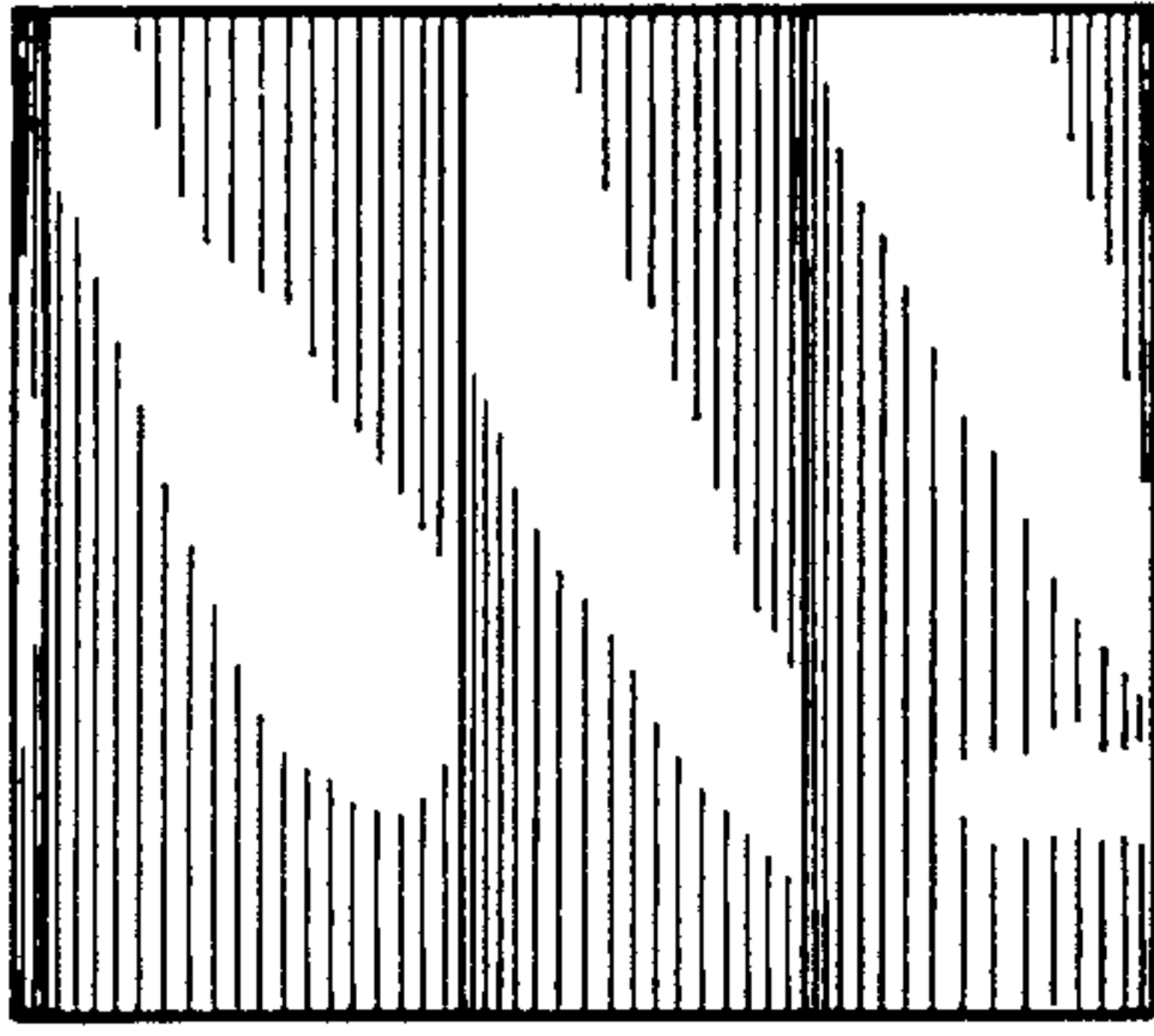

FIG. 7

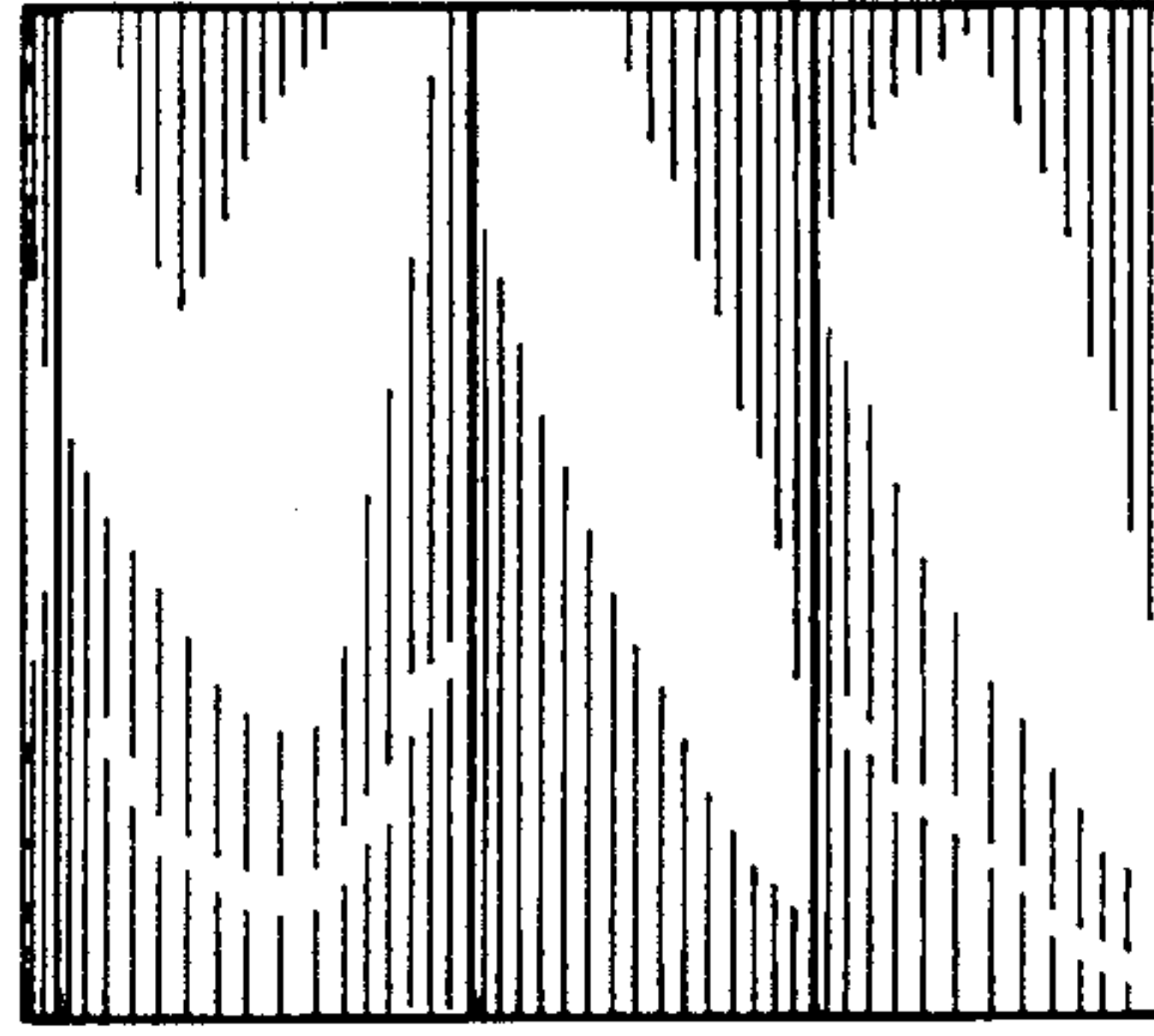

FIG. 8

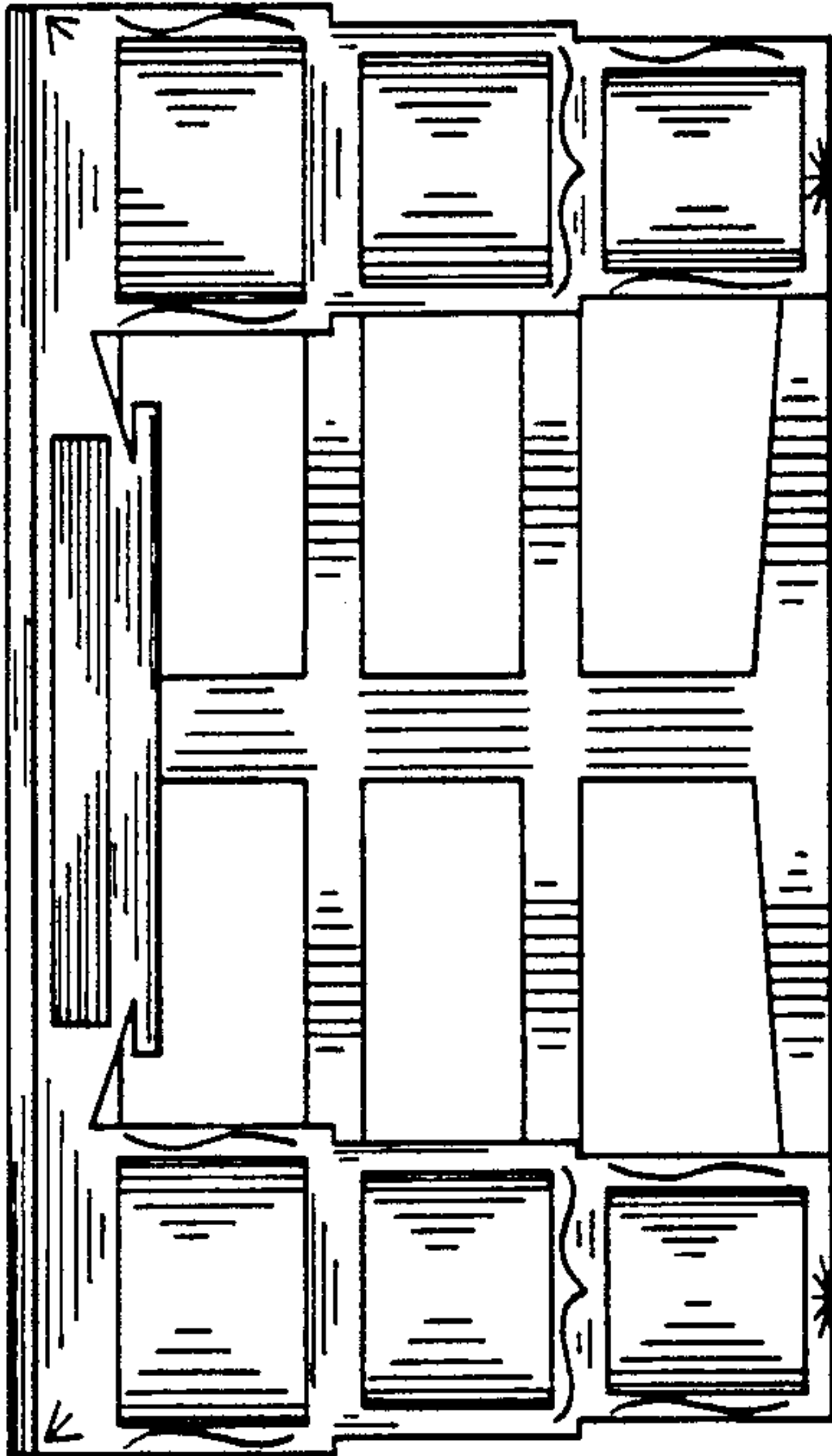

FIG. 5

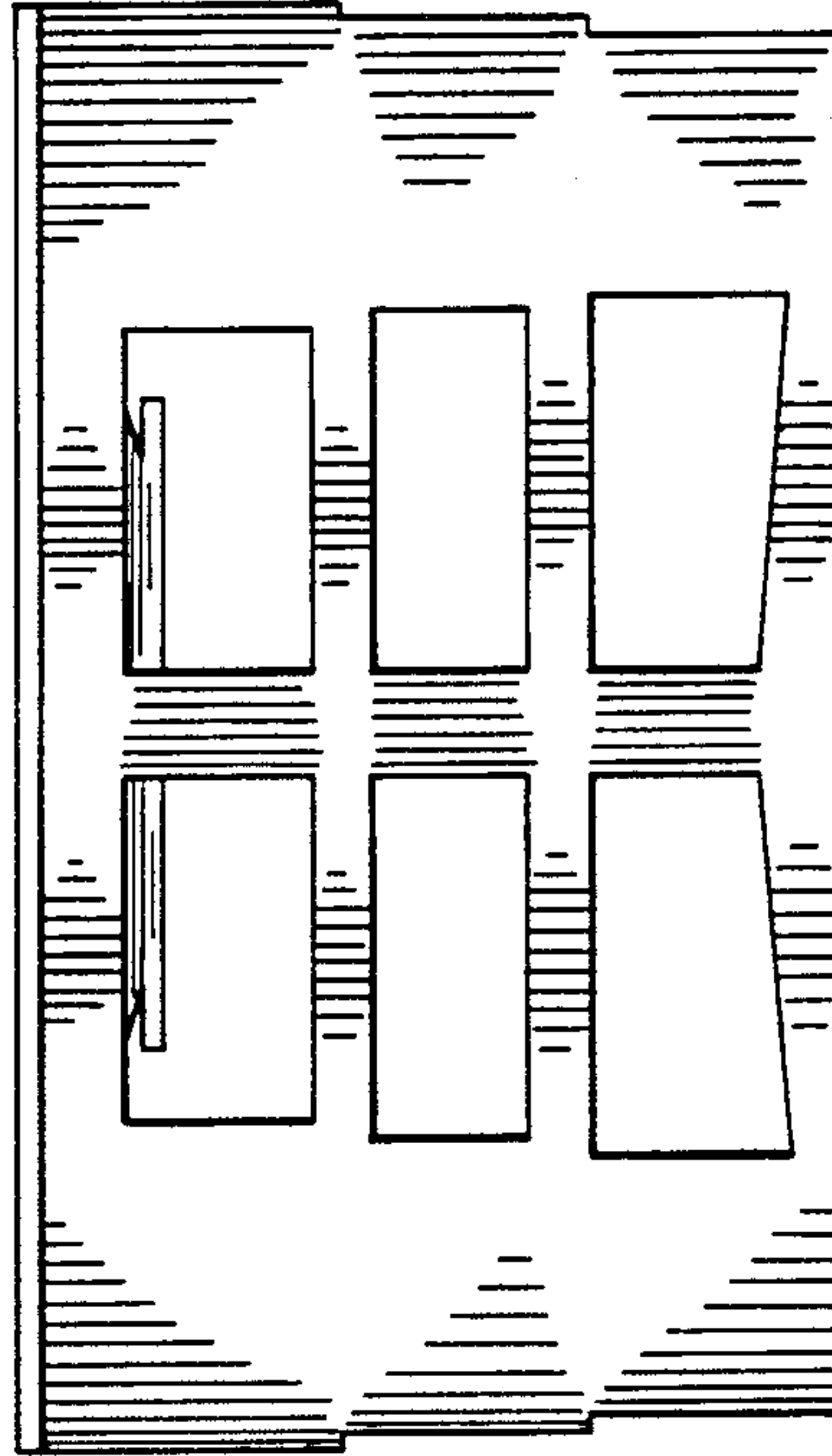

FIG. 6

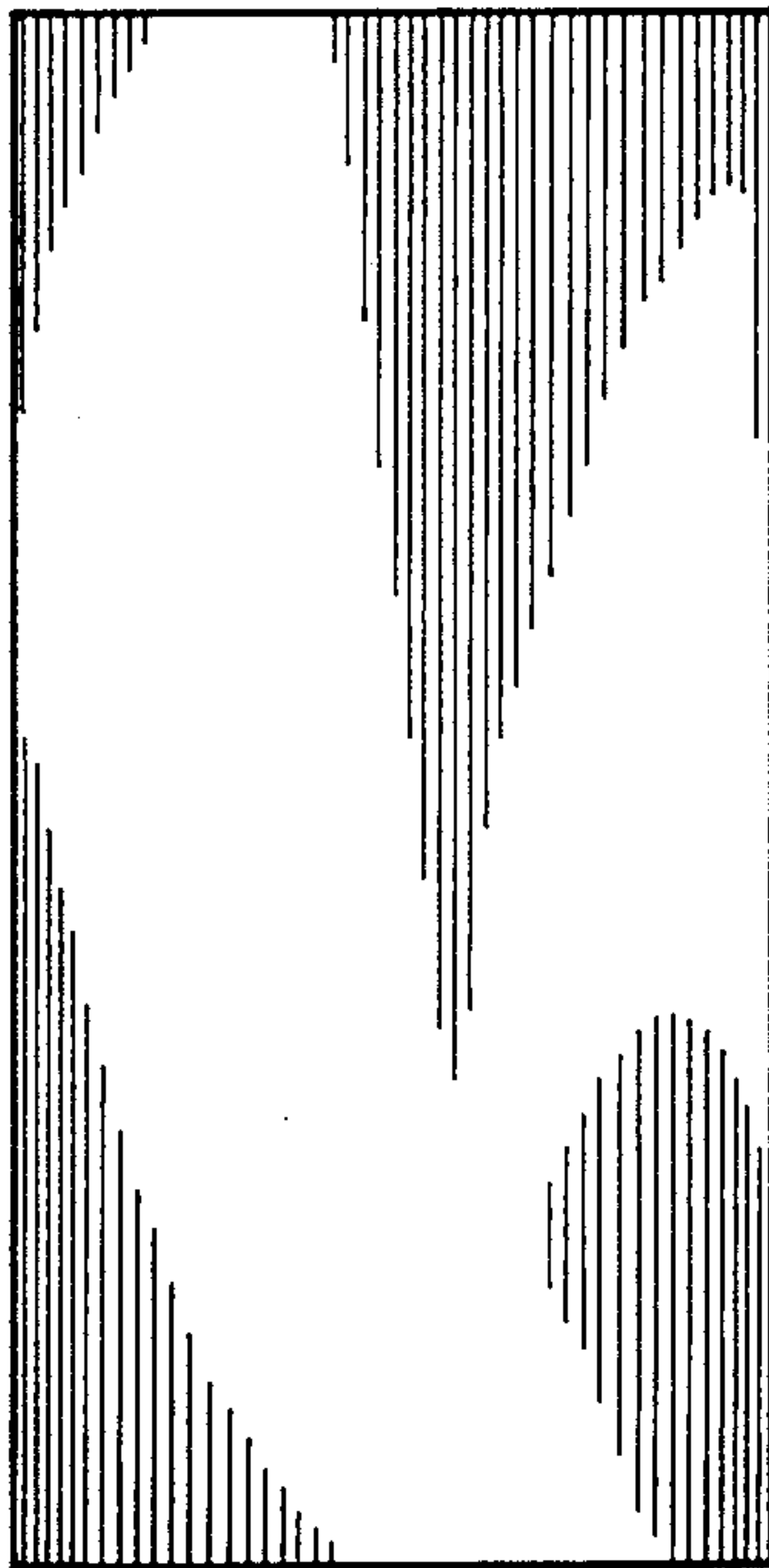

FIG. 3

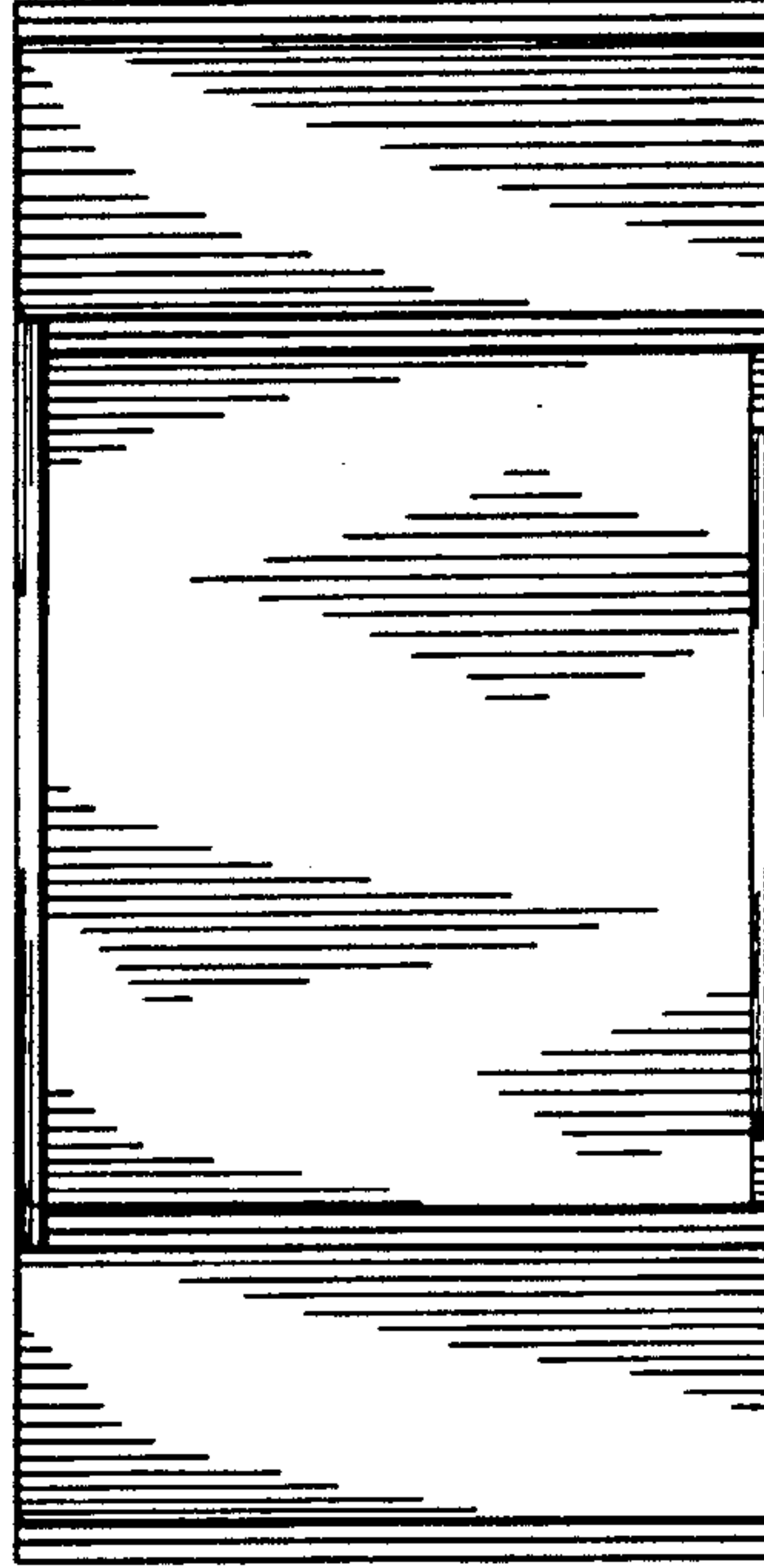

FIG. 4