

[54] COMBINED ELECTRICAL STEAM IRON  
AND RESERVOIR BASE WITH FILTER  
ATTACHMENT

[76] Inventor: Tien-Lai Chen, 4 Fl., No. 20, Min  
Chuan West Rd., Taipei, Taiwan

[\*\*] Term: 14 Years

[21] Appl. No.: 355,306

[22] Filed: May 22, 1989

[52] U.S. Cl. .... D32/68; D32/70;  
D32/73

[58] Field of Search ..... D32/68-73;  
D23/209; 38/69-71, 74-75, 77.1-77.9, 79,  
81-82, 85, 88, 90, 93-94, 96, 141-142;  
219/245-259, 271-273; 248/117.1-117.7

[56] **References Cited**

**U.S. PATENT DOCUMENTS**

D. 132,850	6/1942	Cissell .....	D32/73
D. 238,576	1/1976	Vidal .....	D23/209
D. 249,275	9/1978	MacKay et al. ....	D23/209
2,385,606	9/1945	Campbell .....	38/82 X
4,594,800	6/1986	Herrmann .....	38/77.83

**FOREIGN PATENT DOCUMENTS**

520218	3/1931	Fed. Rep. of Germany ...	248/117.2
--------	--------	--------------------------	-----------

**OTHER PUBLICATIONS**

Housewares, 10/88, Steam Station Irons, p. 23.

*Primary Examiner*—Wallace R. Burke

*Assistant Examiner*—Lavone D. Tabor

*Attorney, Agent, or Firm*—Thomas S. Keaty

[57] **CLAIM**

The ornamental design for a combined electrical steam iron and reservoir base with filter attachment, as shown and described.

**DESCRIPTION**

FIG. 1 is a perspective view of a combined electrical steam iron and reservoir base with filter attachment showing my new design, the filter attachment being omitted for ease and clarity of illustration only;

FIG. 2 is a front elevational view thereof;

FIG. 3 is a rear elevational view thereof;

FIG. 4 is a top plan view thereof;

FIG. 5 is a bottom plan view thereof;

FIG. 6 is a right side elevational view thereof;

FIG. 7 is a left side elevational view thereof; and

FIG. 8 is an exploded perspective view of the reservoir base and filter attachment, the iron being omitted for clarity of illustration only.

The undisclosed sides of the filter attachment are the same in appearance as the side shown.

The conventional cord is shown broken away to indicate indeterminate length and partially shown for ease of illustration.

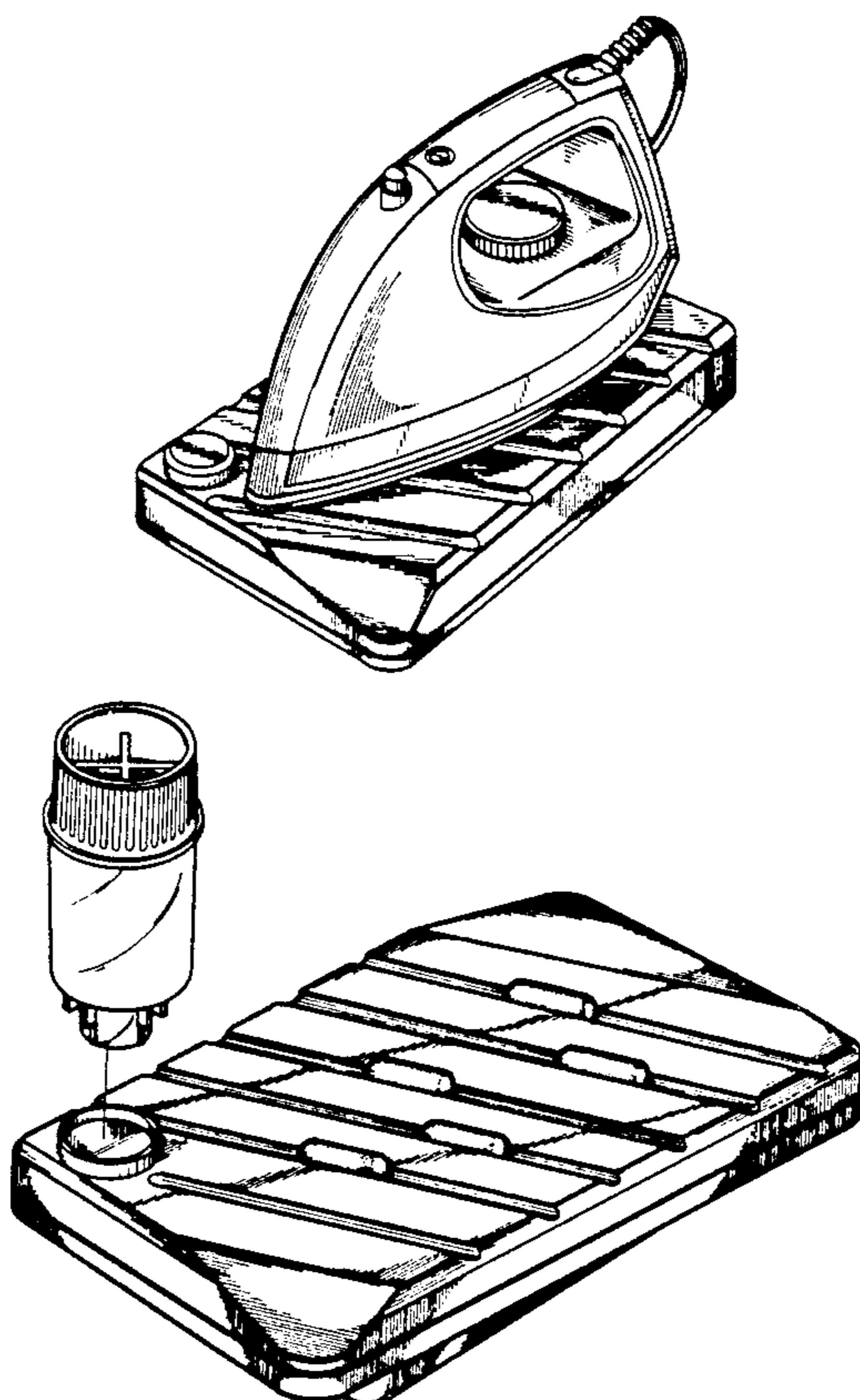

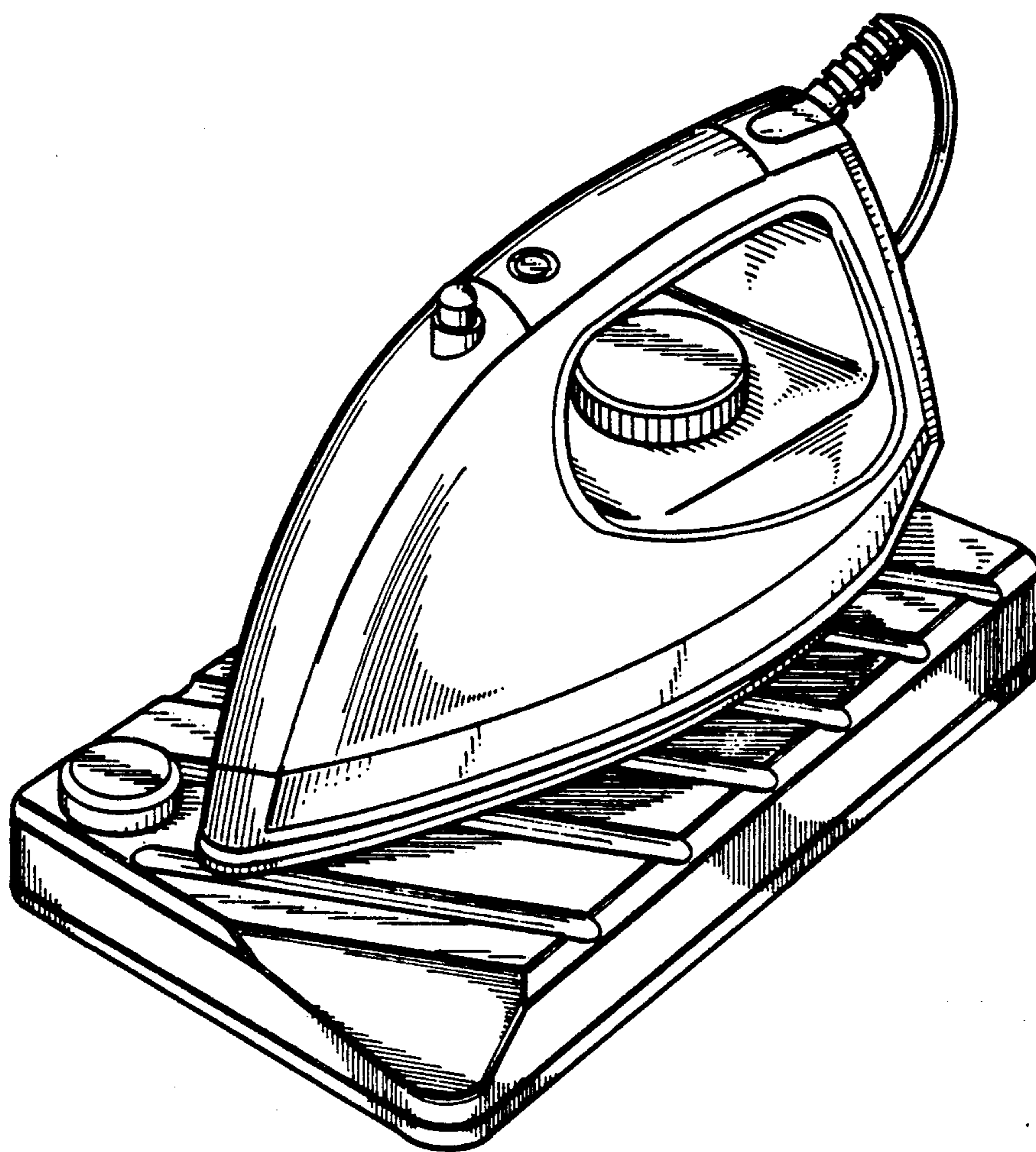

FIG. 1

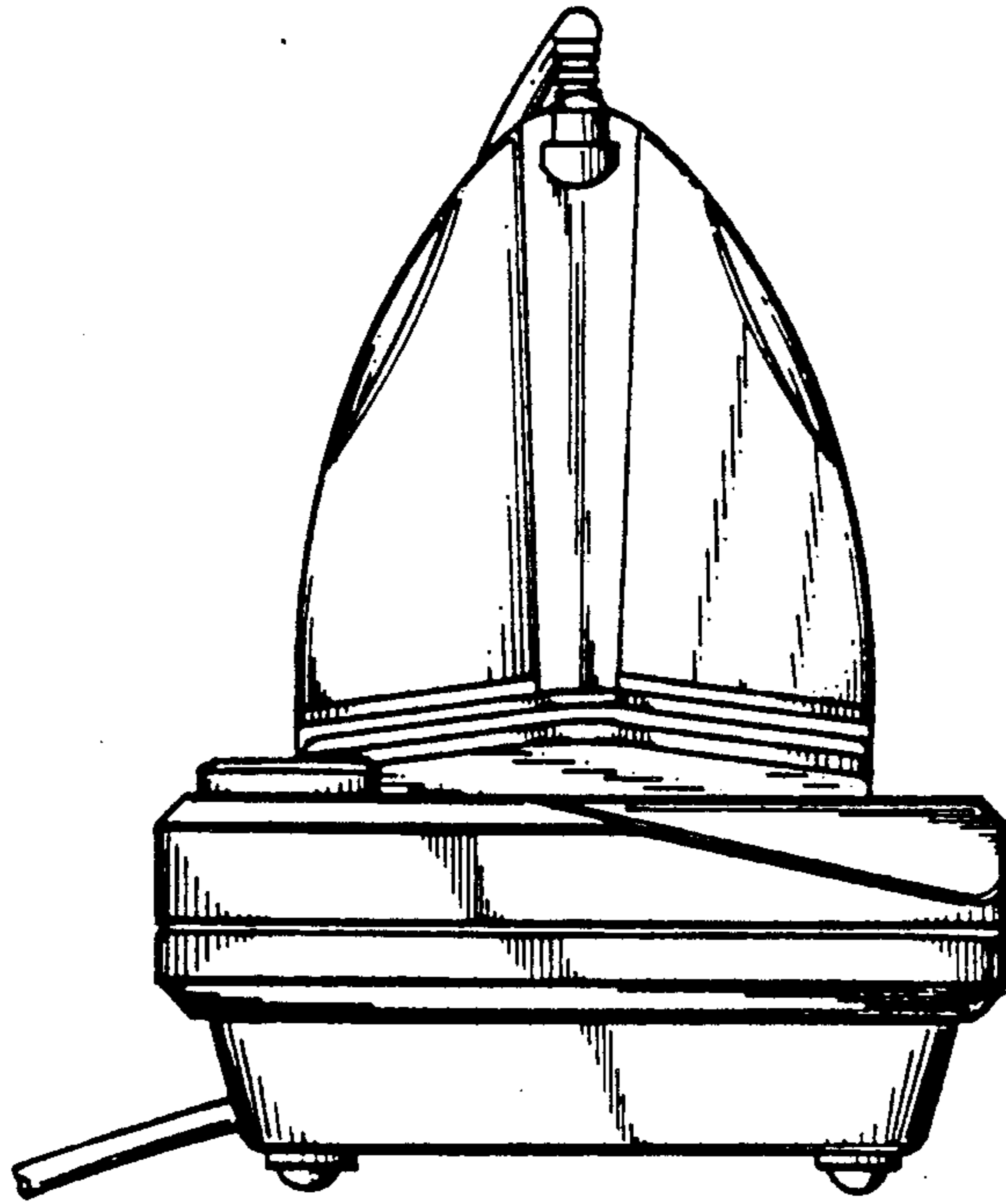

FIG. 2

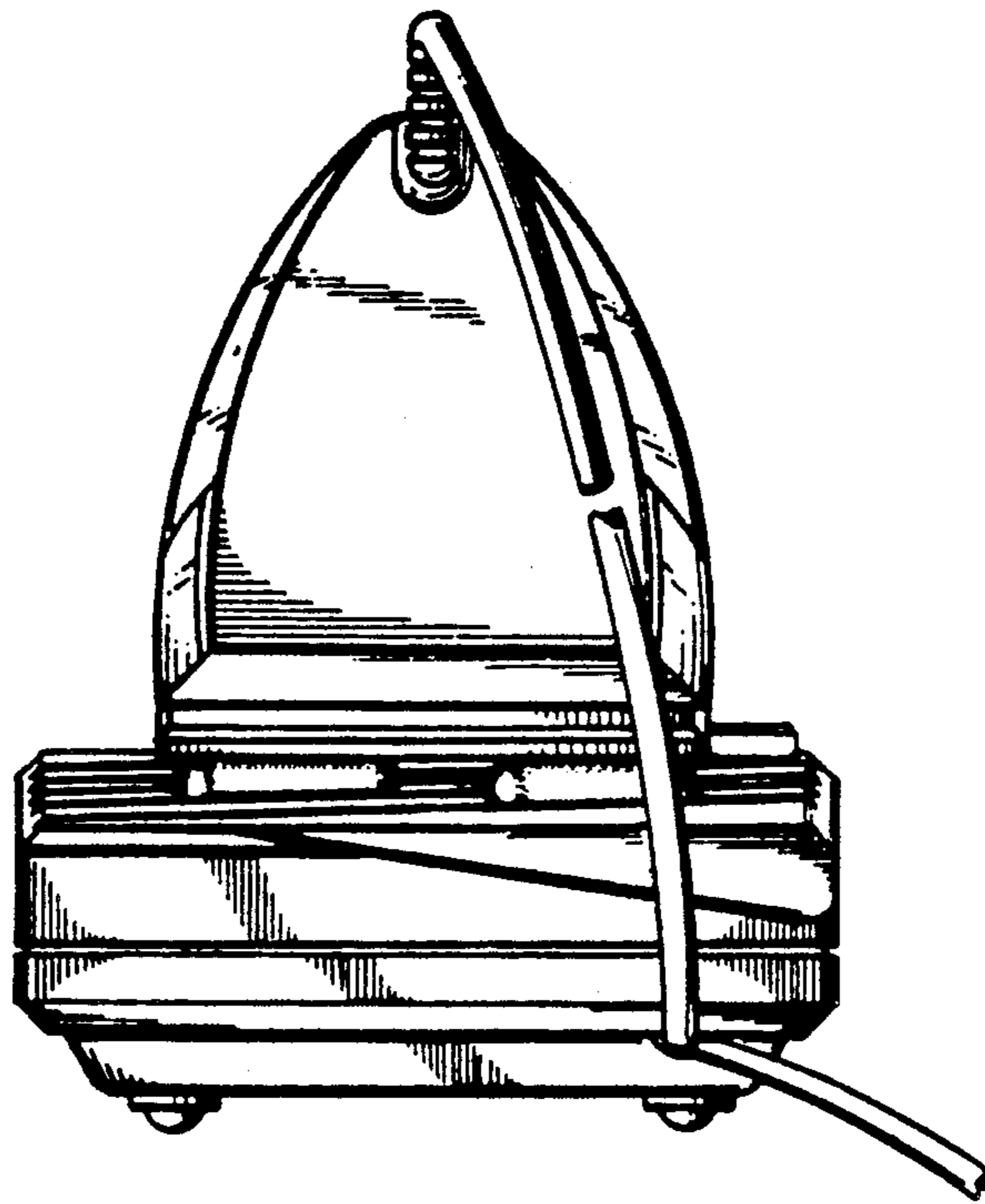

FIG. 3

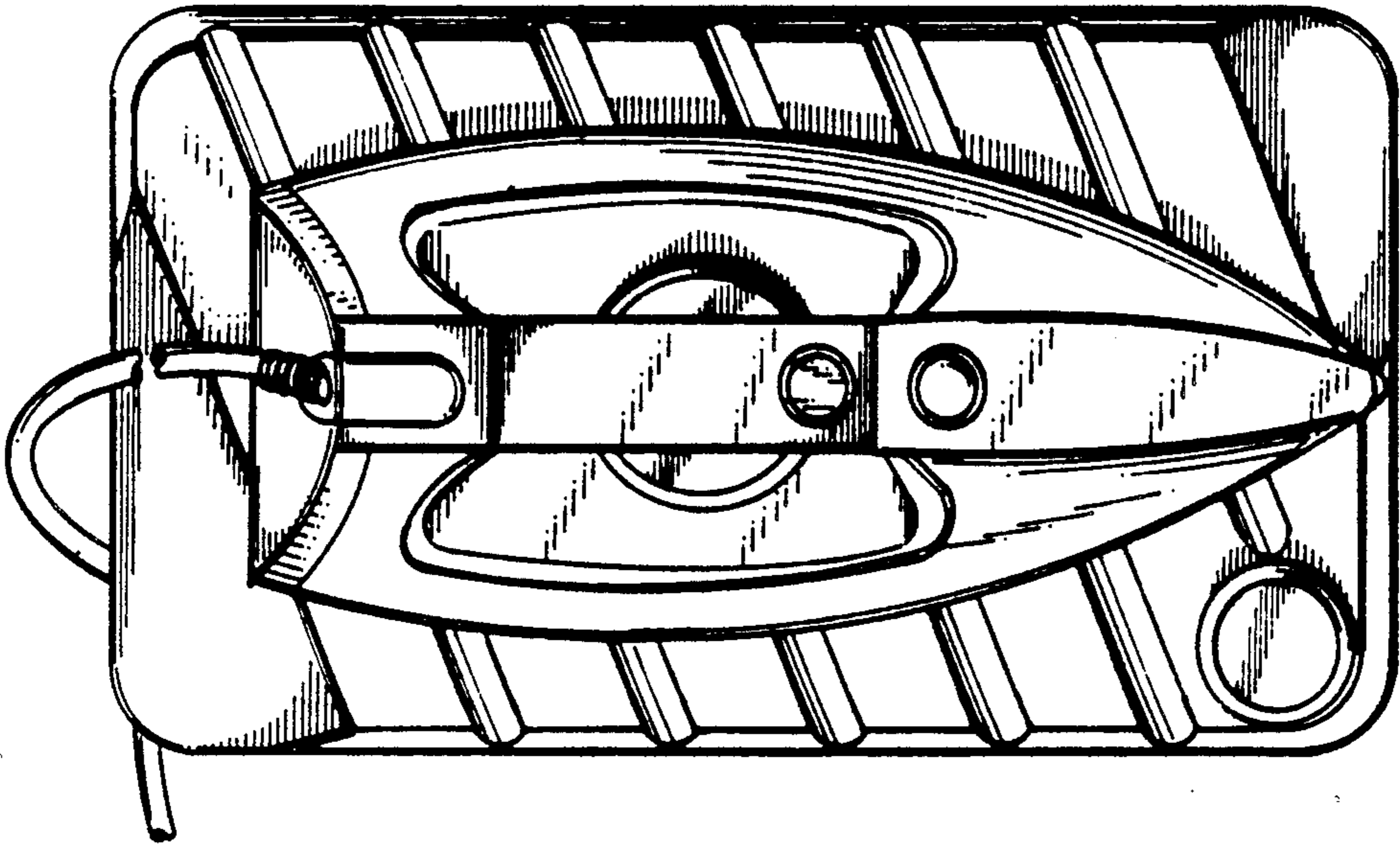

FIG. 4

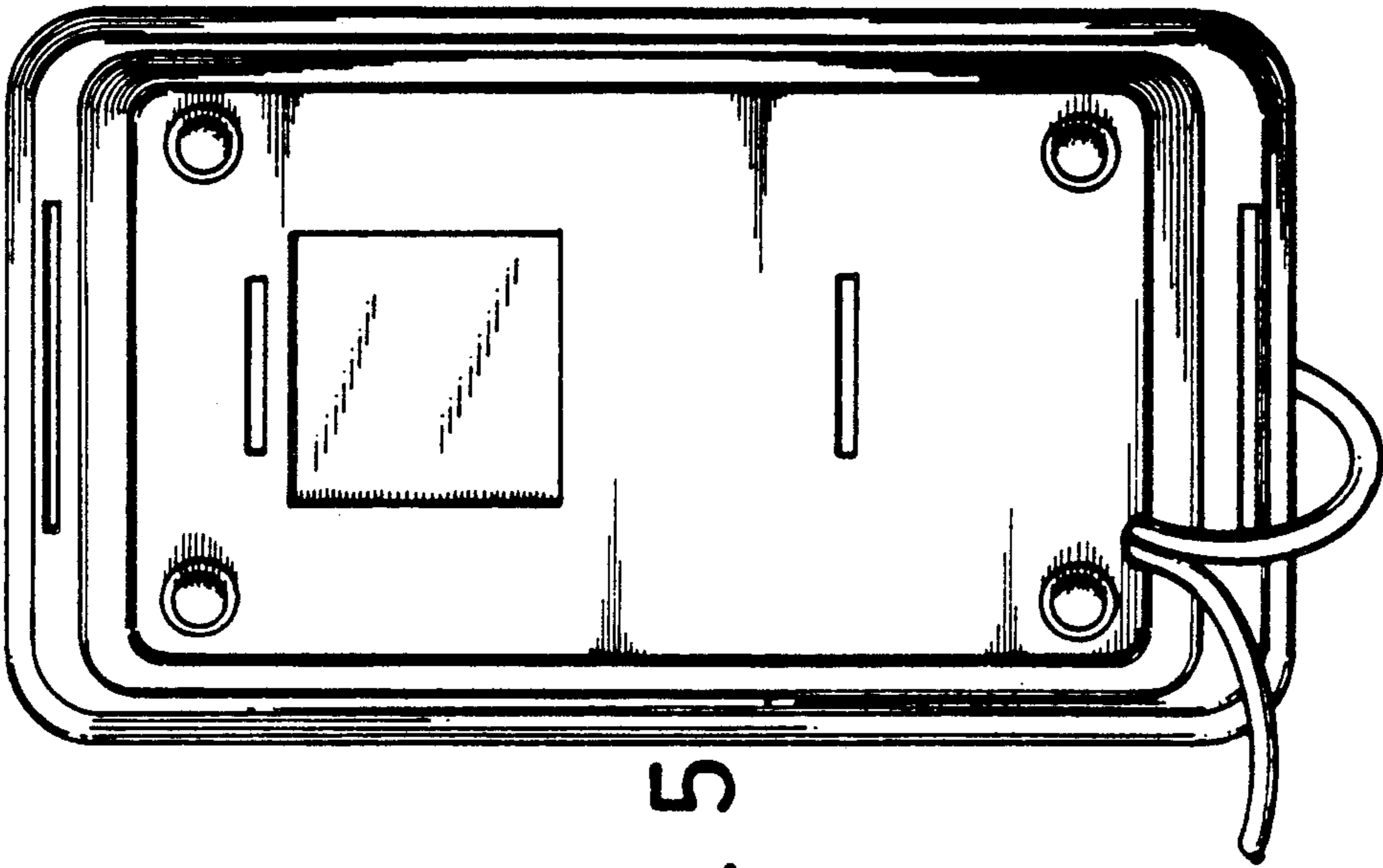

FIG. 5

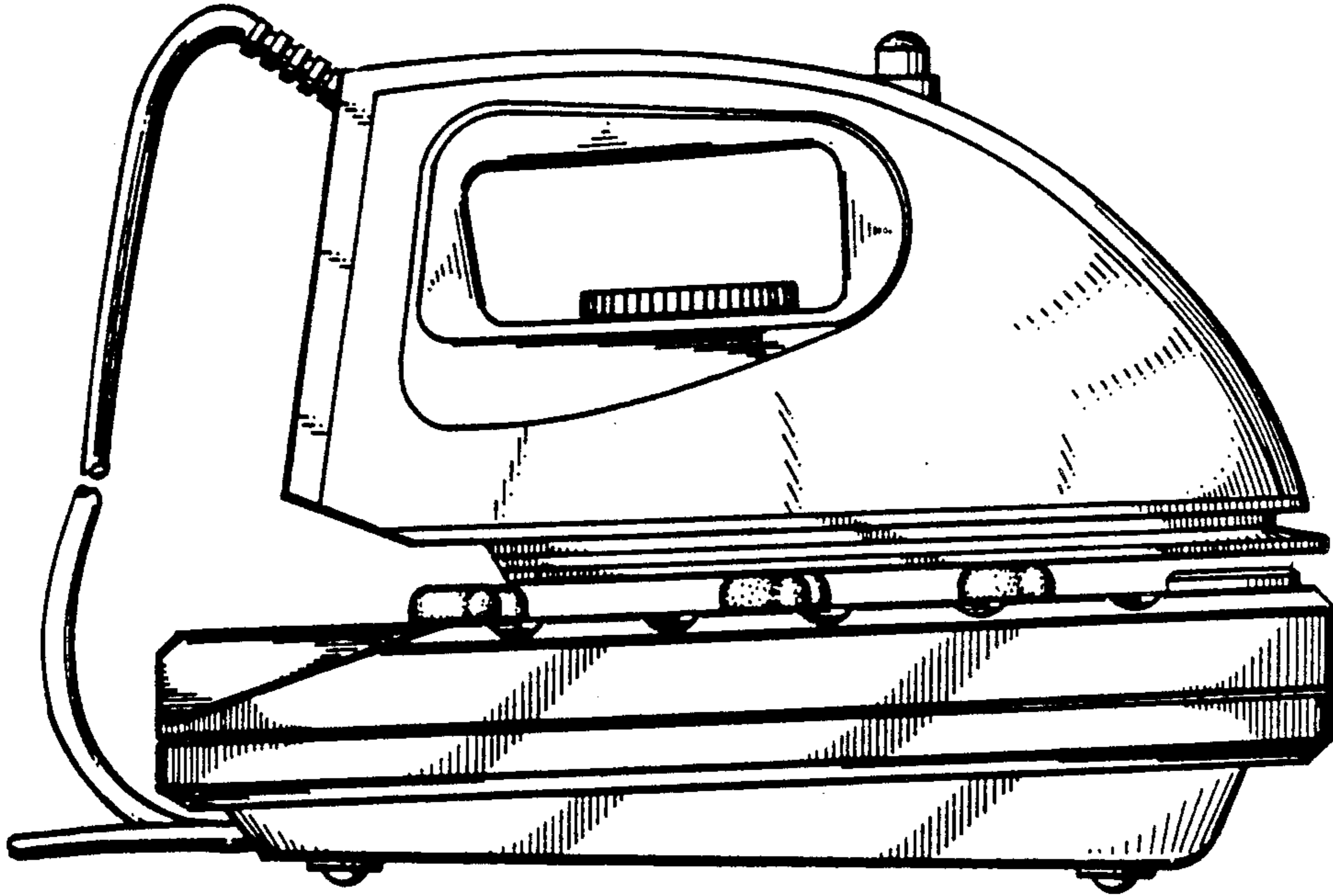

FIG. 6

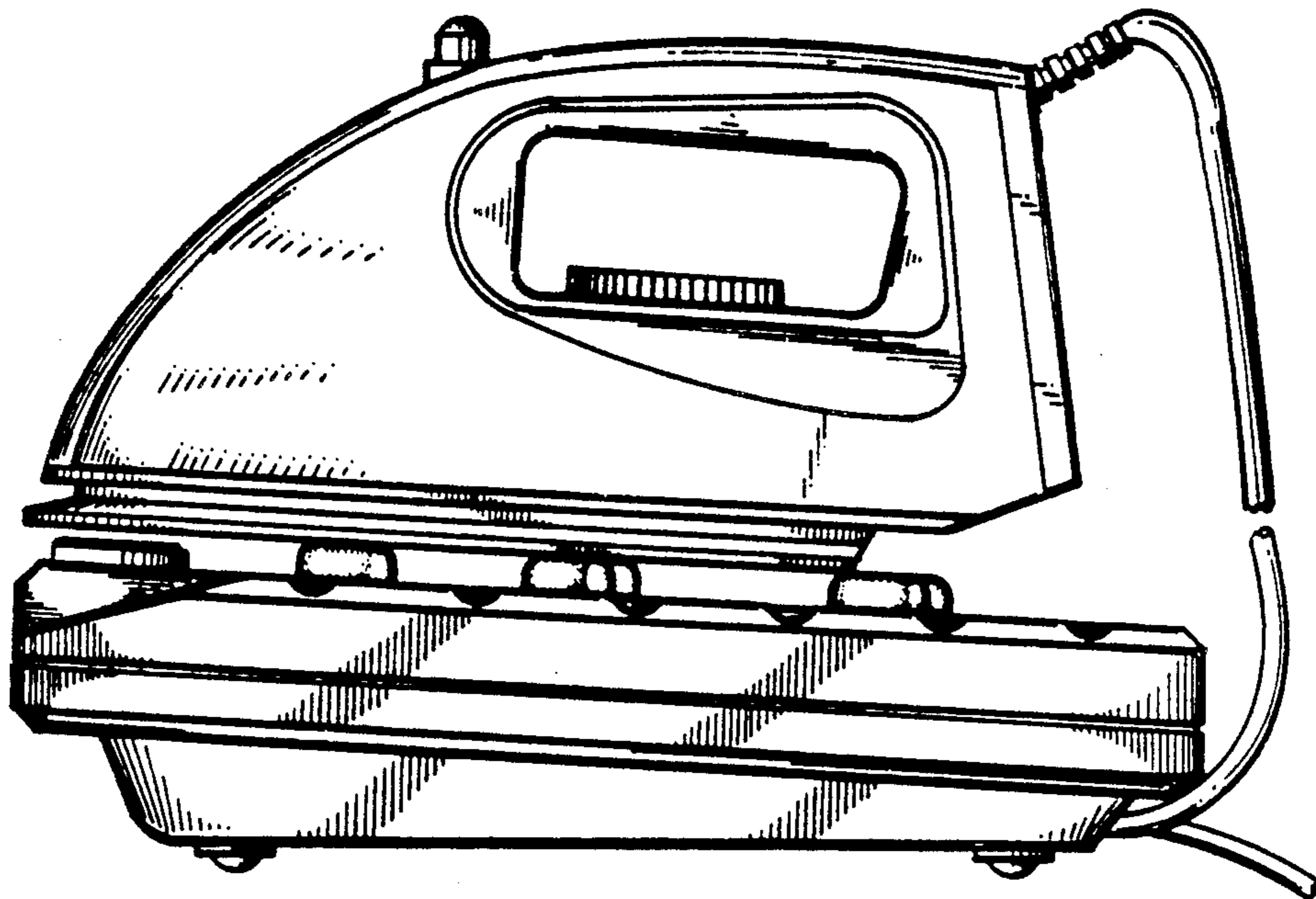

FIG. 7

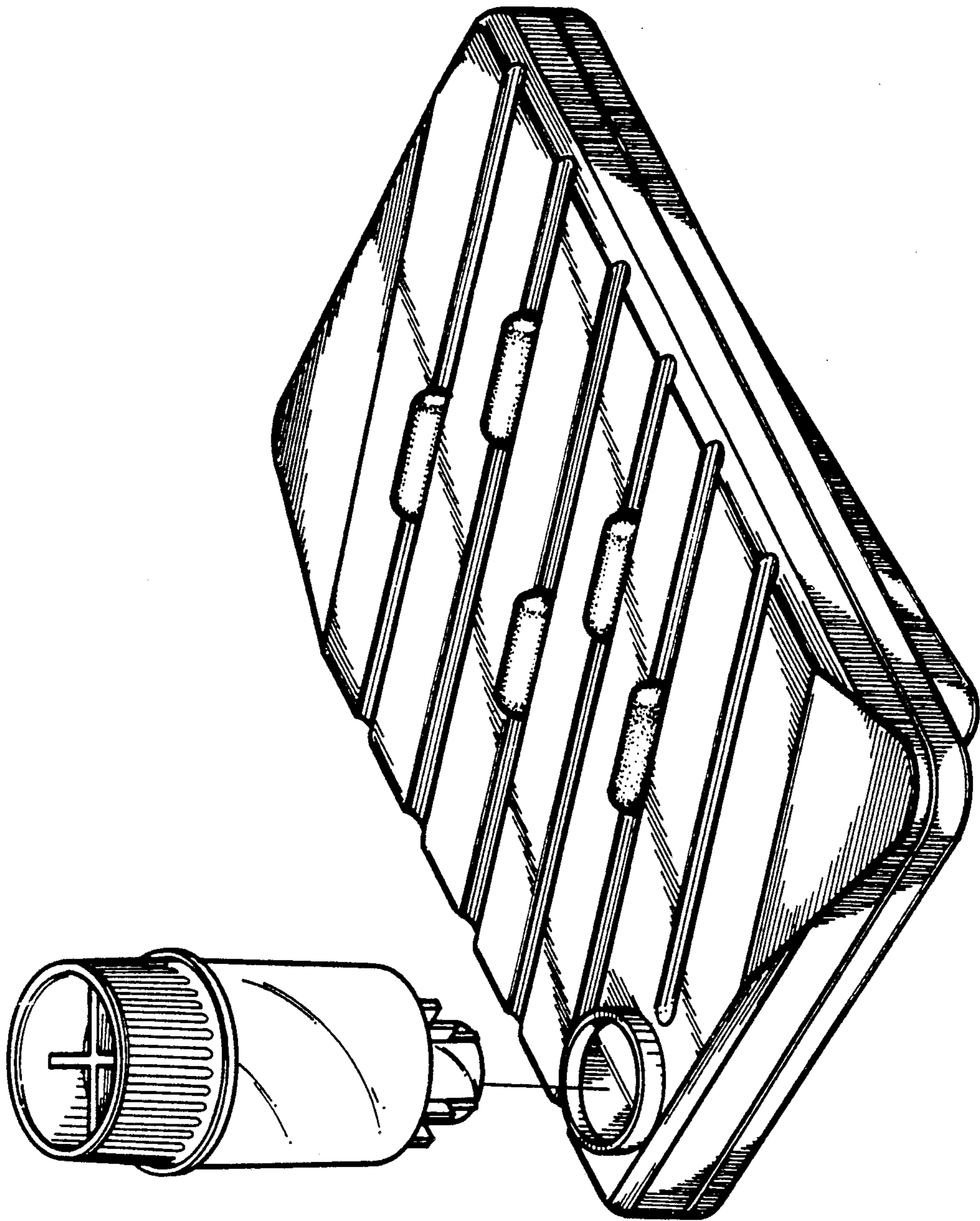

FIG. 8