

[54] GOLF CLUB

DESCRIPTION

[76] Inventor: Carlos S. Alonso, Av. Cantabria 33, 33, 28042 Madrid, Spain

FIG. 1 is a right side elevational view of a first embodiment of my new design for a golf club;

[\*\*] Term: 14 Years

FIG. 2 is a front elevational view thereof;

[21] Appl. No.: 867,262

FIG. 3 is an enlarged fragmentary front elevational view showing the putter head of the embodiments of FIGS. 2 and 3;

[22] Filed: May 20, 1986

FIG. 4 is an enlarged fragmentary top view of the putter head of FIG. 3;

[30] Foreign Application Priority Data

Nov. 29, 1985 [ES] Spain ..... 109500

FIG. 5 is an enlarged fragmentary left side elevational view of the putter head of FIG. 3;

[52] U.S. Cl. .... D21/219

FIG. 6 is an enlarged fragmentary bottom view of the putter head of FIG. 3;

[58] Field of Search ..... D21/214-220; 273/164, 167-175, 78

FIG. 7 is an enlarged fragmentary rear elevational view of the putter of FIG. 3;

[56] References Cited

U.S. PATENT DOCUMENTS

D. 228,003 7/1973 Warner ..... D21/219

FIG. 8 is a right side elevational view of a second embodiment of my new design for a golf club;

D. 269,537 6/1983 Tucker ..... D21/219

FIG. 9 is a front elevational view thereof;

1,537,320 5/1925 Marsh ..... 273/167 G

FIG. 10 is an enlarged fragmentary front elevational view of the embodiment of FIGS. 8 and 9;

4,138,117 2/1979 Dalton ..... 273/167 F

FIG. 11 is an enlarged fragmentary top view of the putter head depicted in FIG. 8;

4,422,638 12/1983 Tucker ..... 273/78

FIG. 12 is an enlarged fragmentary left side elevation view of the putter head of FIG. 10;

Primary Examiner—Melvin B. Feifer

Attorney, Agent, or Firm—Ladas & Parry

[57] CLAIM

The ornamental design for a golf club, as shown and described.

FIG. 13 is an enlarged fragmentary bottom view of the putter head of FIG. 10; and

FIG. 14 is an enlarged fragmentary rear elevational view of the putter head of FIG. 10.

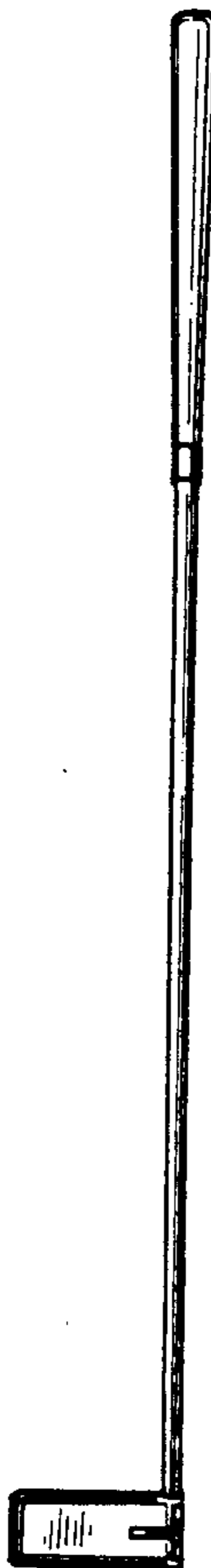

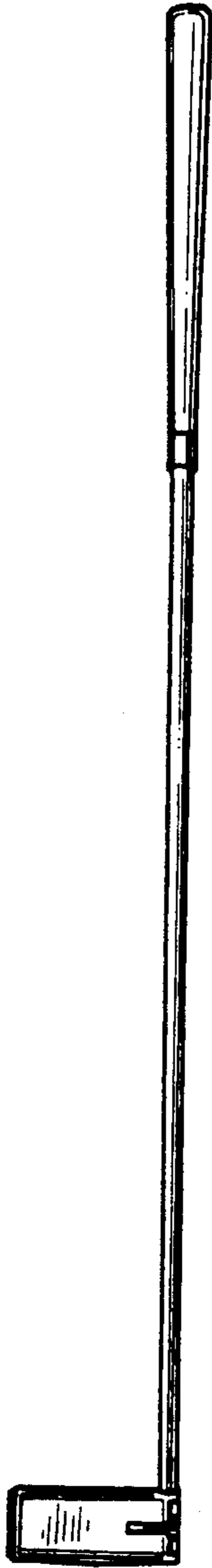

FIG. 1

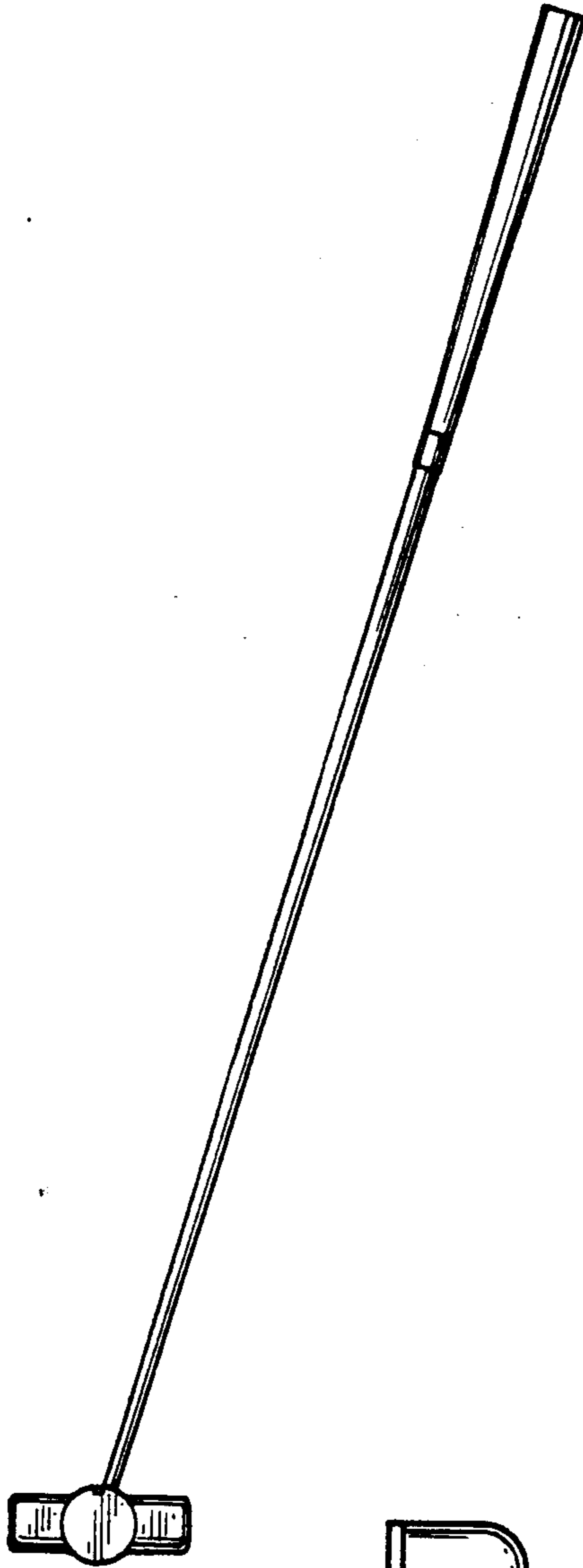

FIG. 2

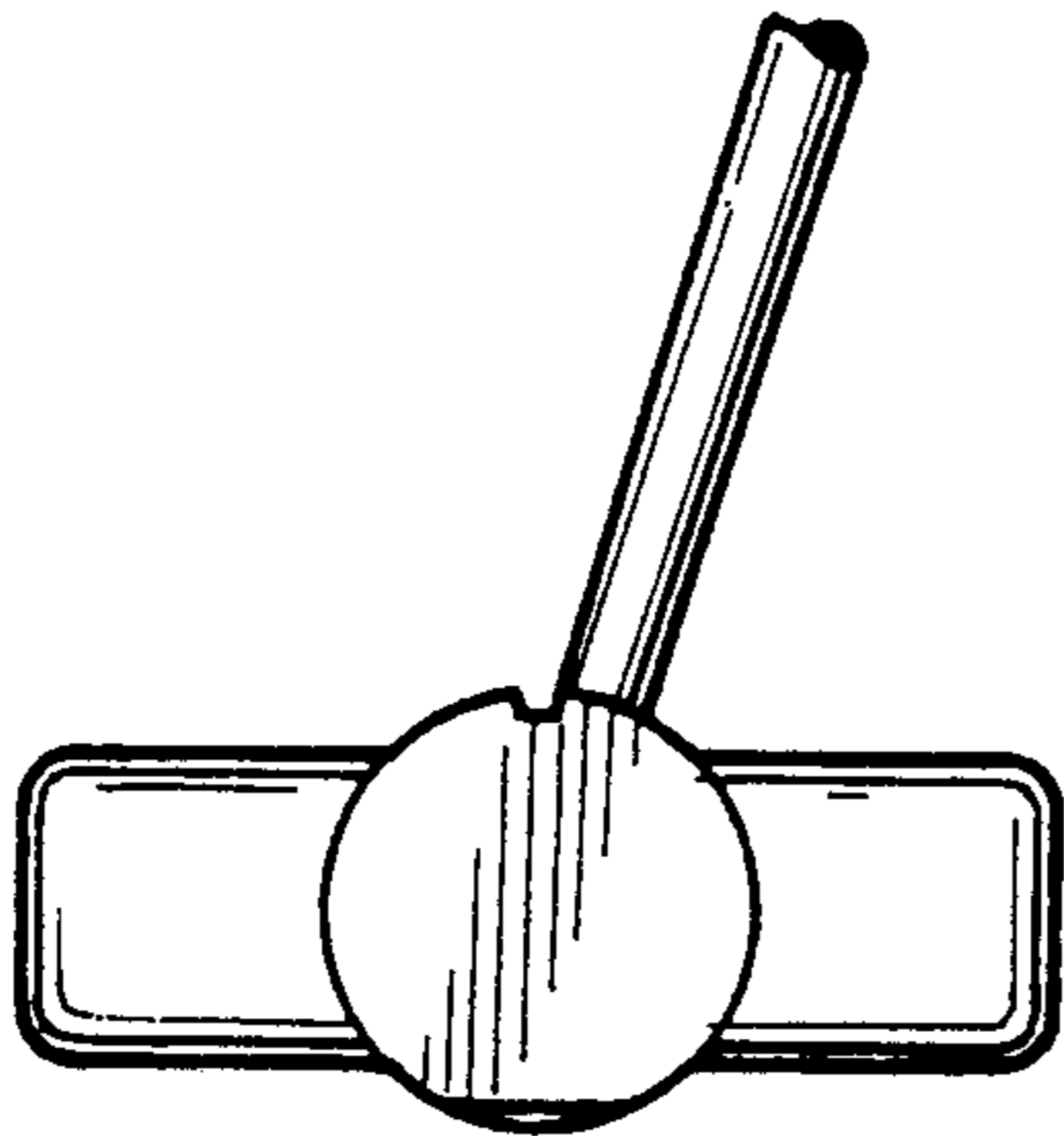

FIG. 3

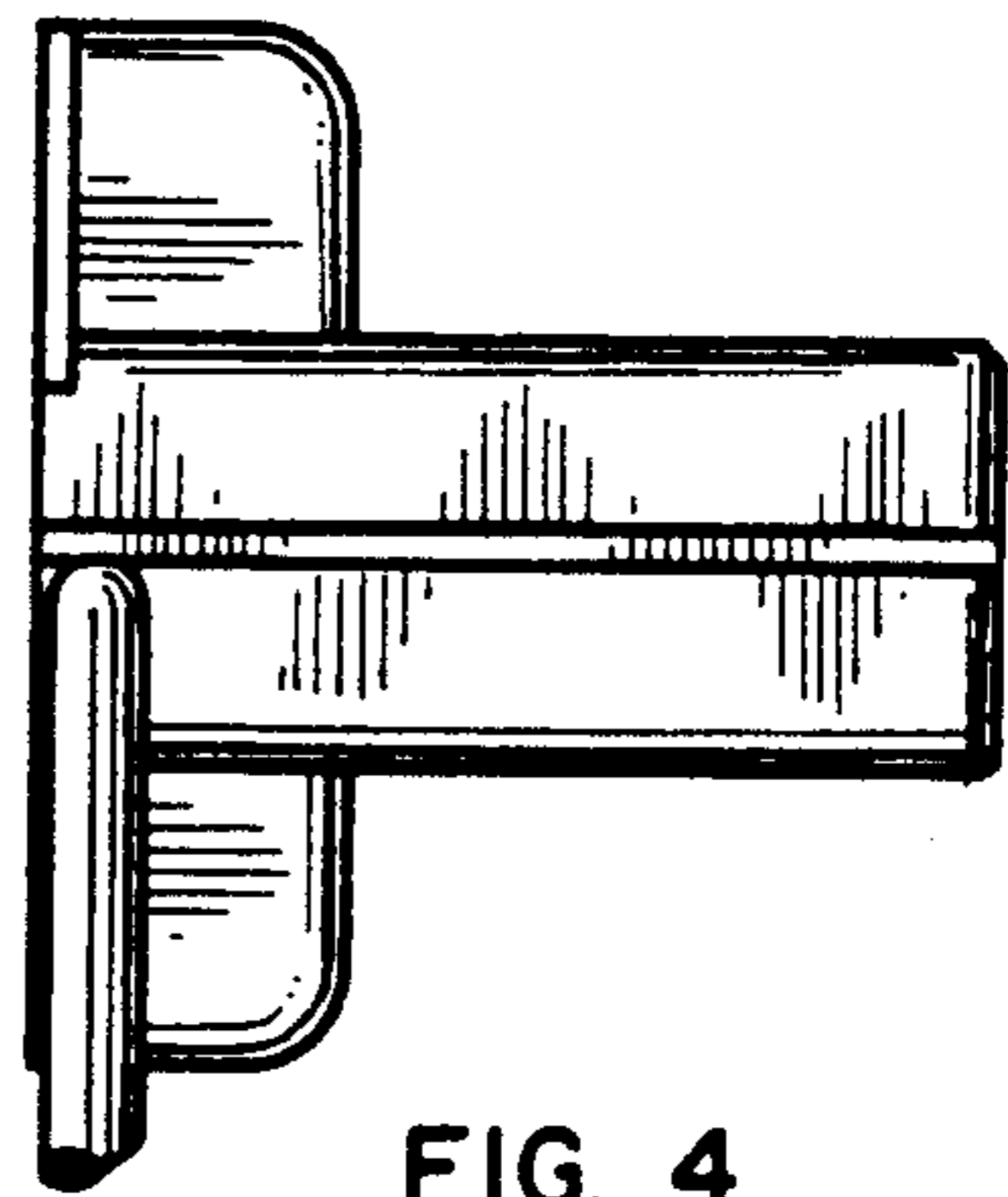

FIG. 4

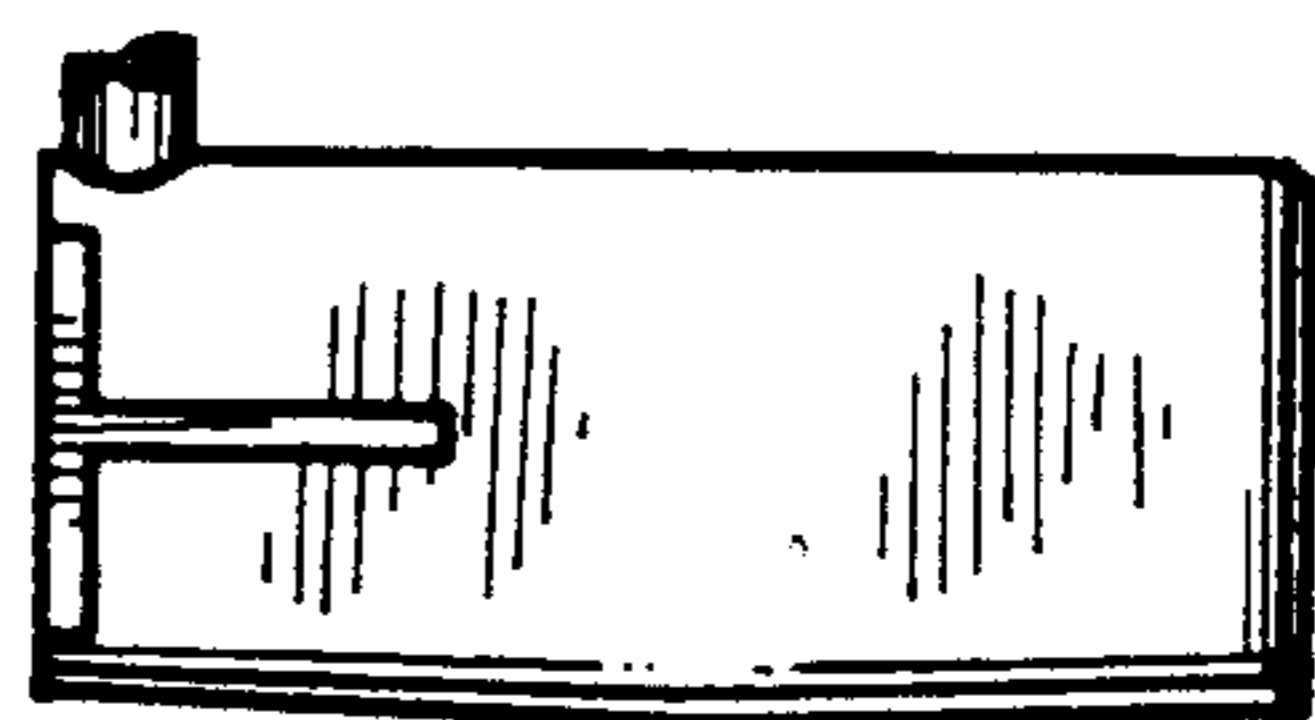

FIG. 5

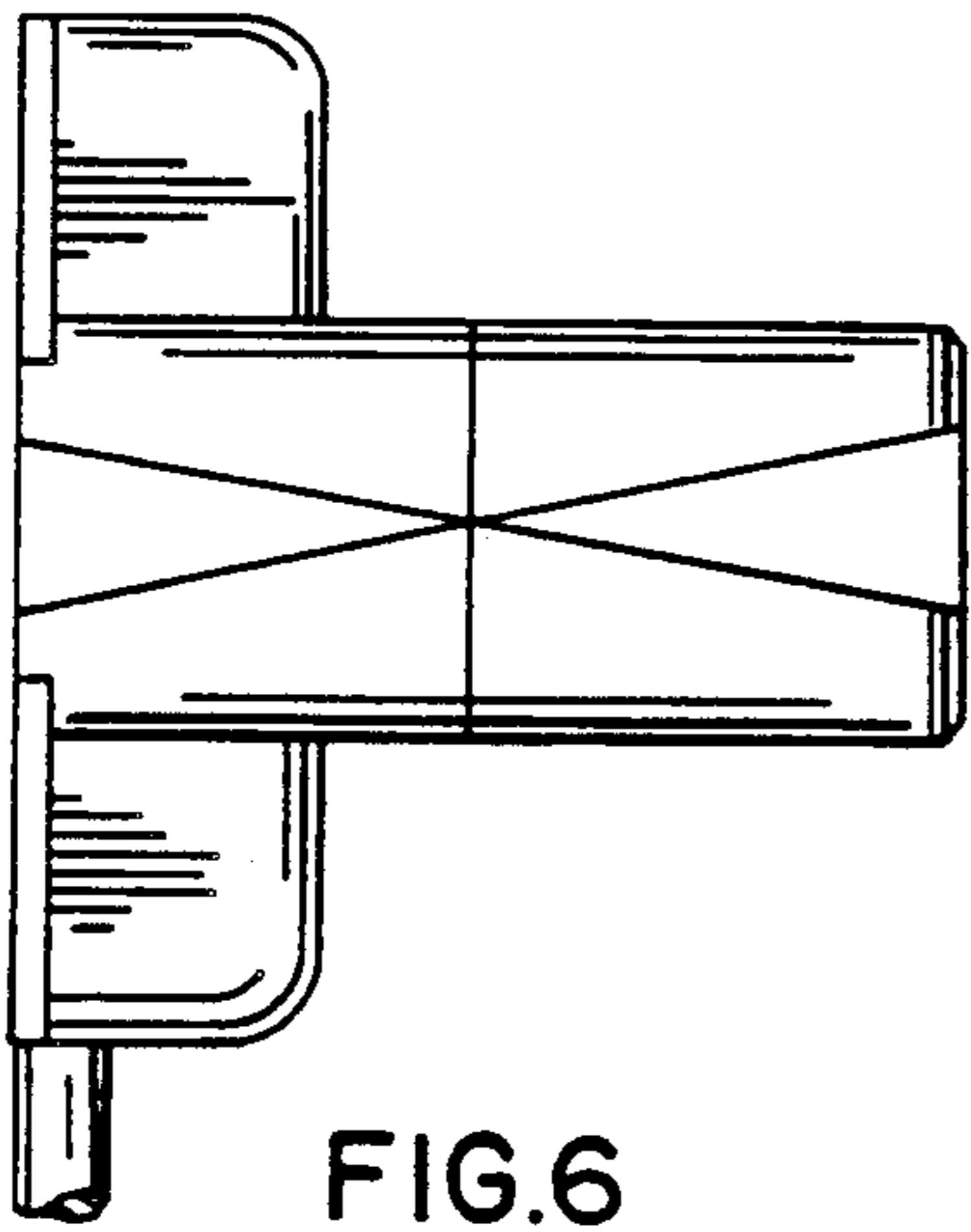

FIG. 6

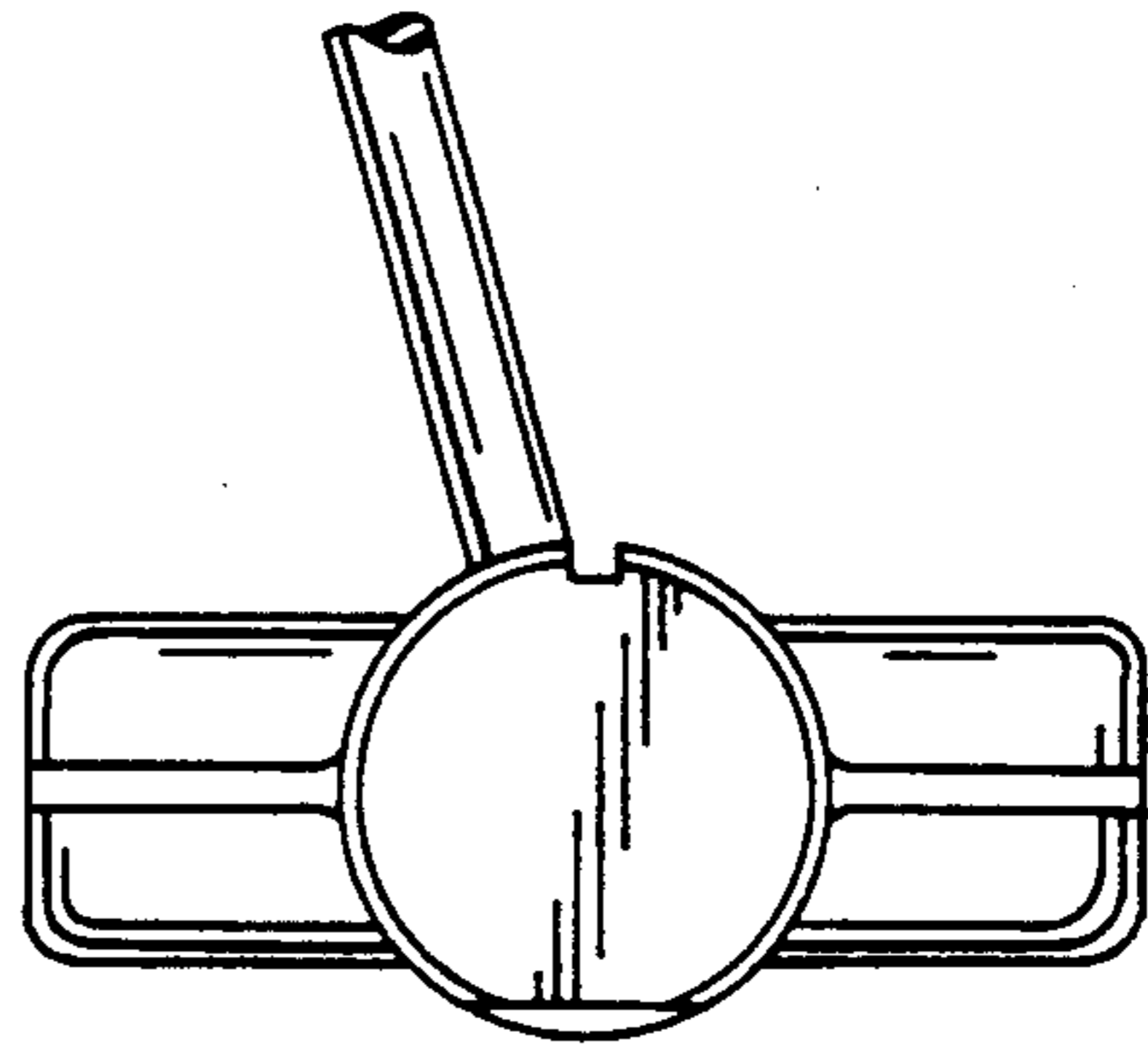

FIG. 7

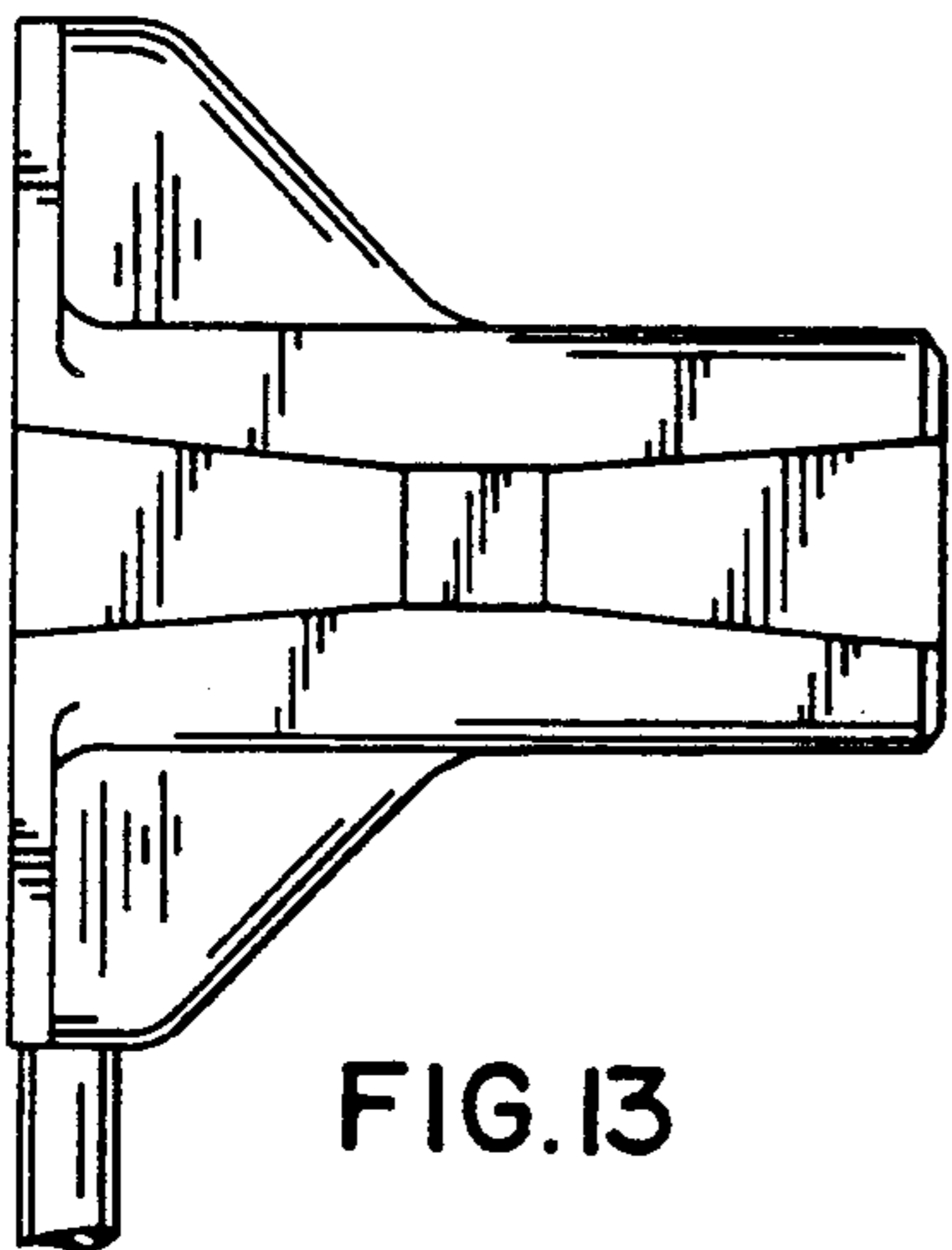

FIG. 13

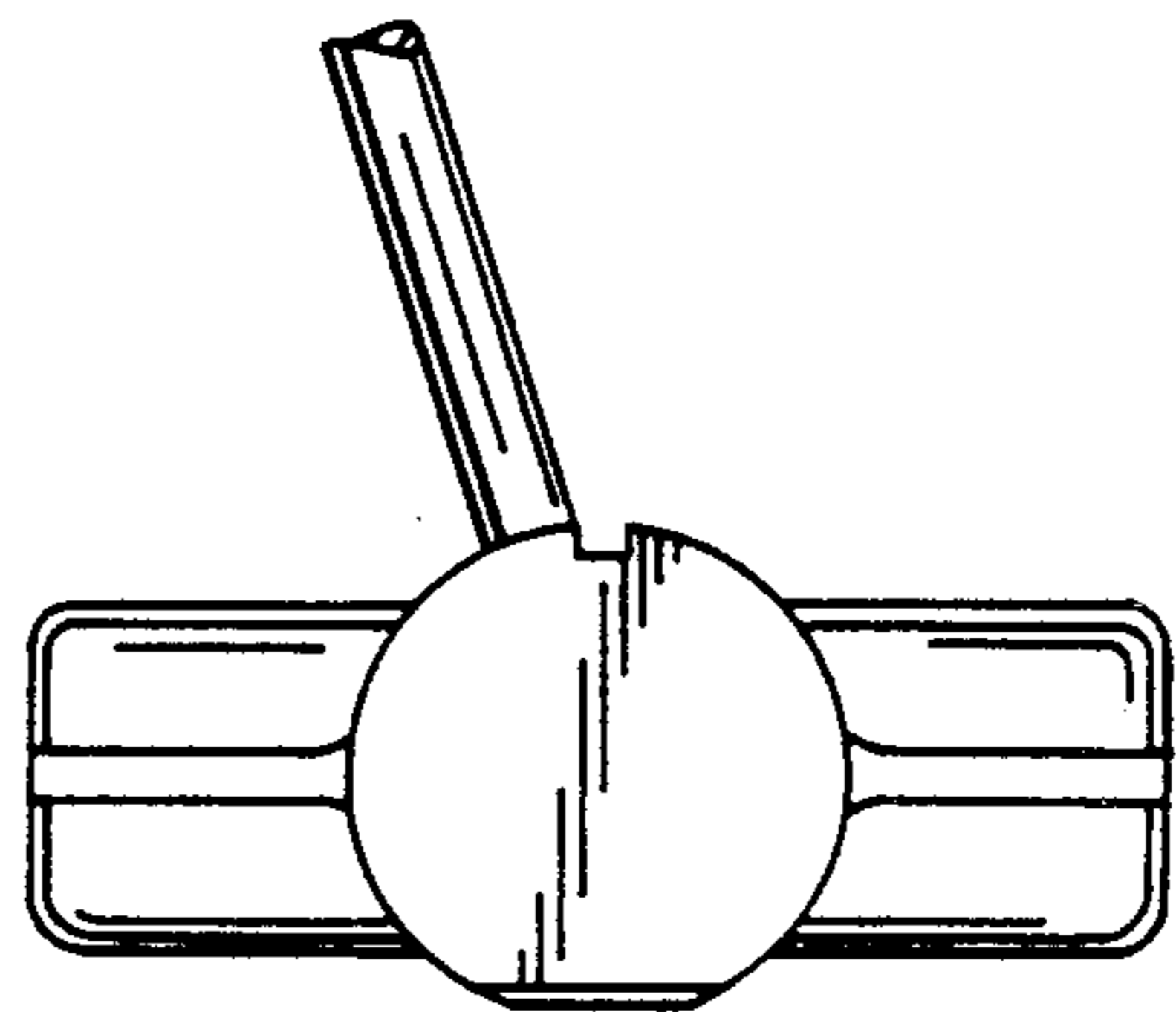

FIG. 14

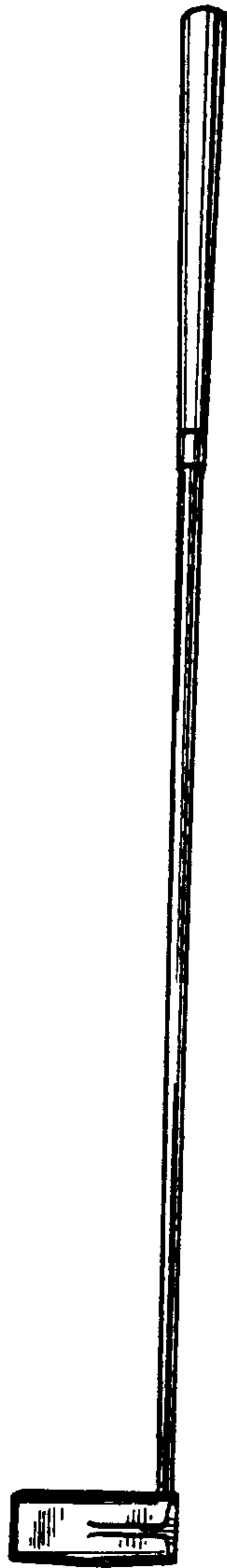

FIG. 8

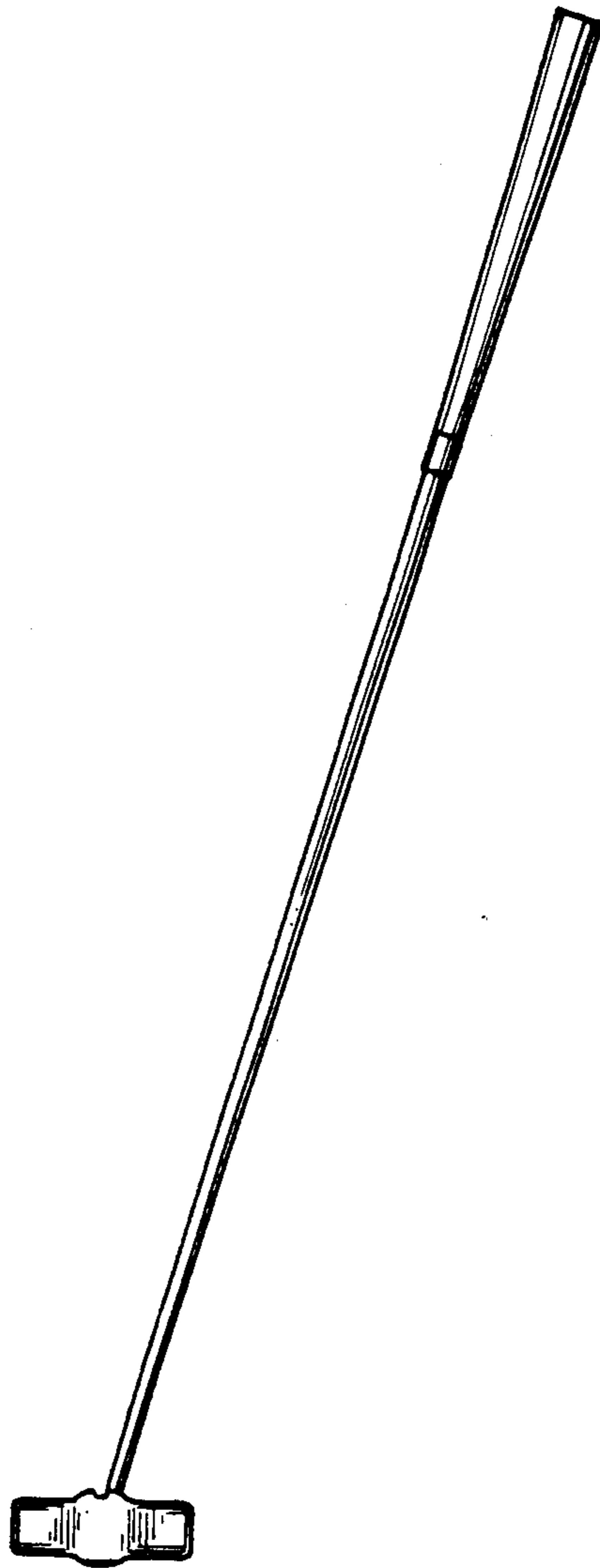

FIG. 9

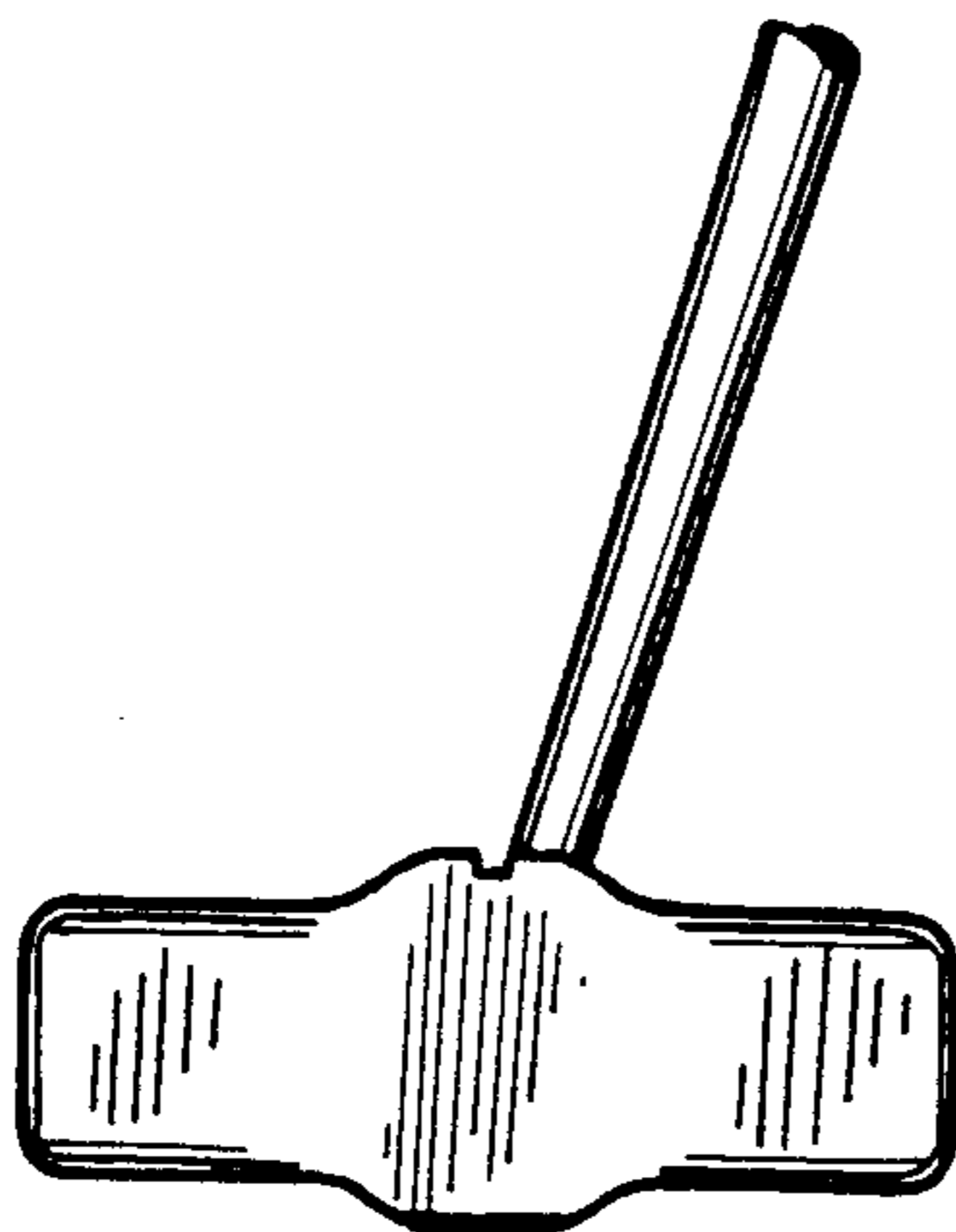

FIG. 10

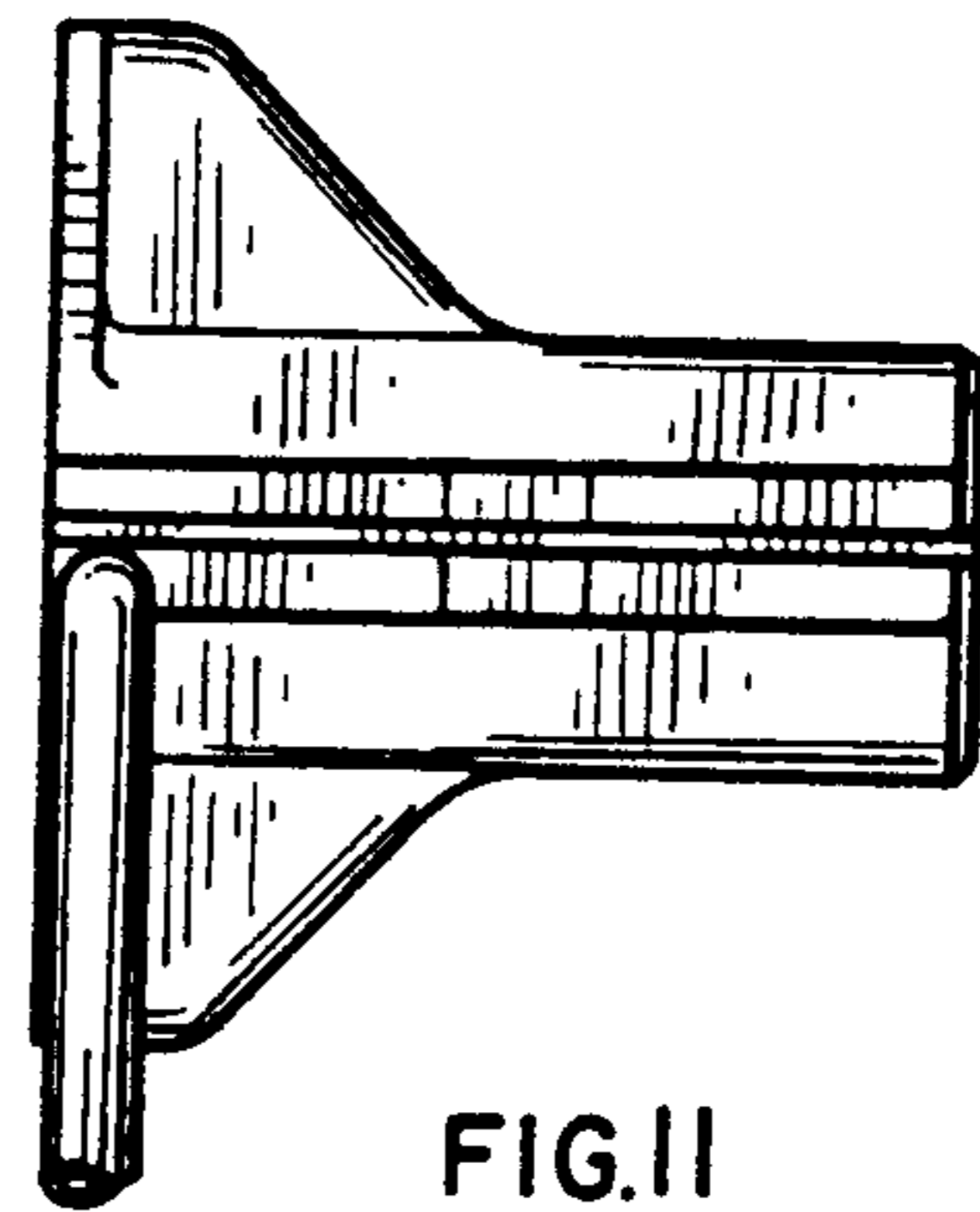

FIG. 11

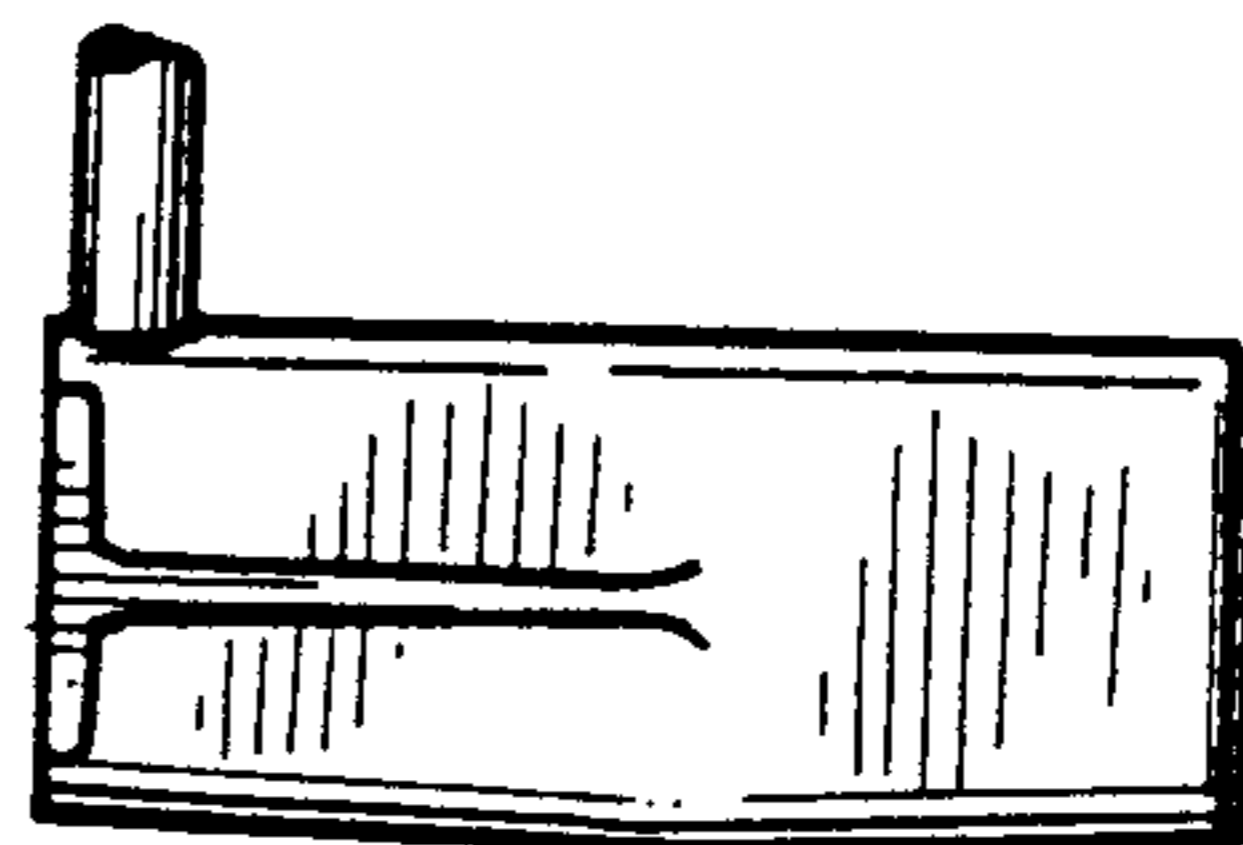

FIG. 12