

[54] DRYWALL MARKER

[76] Inventors: Jeffery S. Reynolds; Cindy L. Reynolds, both of 5114 Rock Eagle Dr., Stone Mountain, Ga. 30083; Danny M. Reynolds; Dara Reynolds, both of 4286 Linda La., Lilburn, Ga. 30247

[\*\*] Term: 14 Years

[21] Appl. No.: 281,471

[22] Filed: Dec. 8, 1988

[52] U.S. Cl. .... D10/64

[58] Field of Search ..... D10/61, 64, 65; 33/528, 33/562, 565, 566, 574, 575, 576, 577, 578, 579, 644, 669, DIG. 9, DIG. 10

[56] References Cited

U.S. PATENT DOCUMENTS

D. 242,903	1/1977	Benoit	.....	D10/64
D. 242,904	1/1977	Benoit	.....	D10/64
1,222,961	4/1917	Maker	.....	33/669 X
1,260,226	3/1918	Maker	.....	33/669 X
2,775,812	1/1957	Mohr	.....	33/526 X
2,809,440	3/1957	Schlage	.....	33/579 X
2,887,776	5/1959	Eisner	.....	33/528
2,898,688	4/1959	Cottar	.....	33/528
2,992,490	7/1961	Hay et al.	.....	33/528
3,940,857	3/1976	Giordano	.....	33/578 X
4,059,905	11/1977	Wieting	.....	33/528
4,259,785	4/1981	Wortham	.....	33/528
4,339,973	7/1982	Lawrence	.....	33/DIG. 10 X
4,589,211	5/1986	Policka	.....	33/669
4,837,942	6/1989	Watts	.....	33/574 X

Primary Examiner—Nelson C. Holtje  
Assistant Examiner—Antoinc D. Davis  
Attorney, Agent, or Firm—Thomas & Kerr

[57] CLAIM

The ornamental design for a drywall marker, as shown and described.

DESCRIPTION

FIG. 1 is a top, front, and left side perspective view of a drywall marker showing our new design, the dotted line showing of a fragmented corner of a utility box is environmental only and forms no part of the claimed design;

FIG. 2 is a top plan view;

FIG. 3 is a bottom plan view;

FIG. 4 is a front elevational view;

FIG. 5 is a rear elevational view;

FIG. 6 is a top, front, and left side perspective view of a second embodiment of FIGS. 1-5 showing our new design;

FIG. 7 is a top plan view;

FIG. 8 is a bottom plan view;

FIG. 9 is a right side elevational view;

FIG. 10 is a rear elevational view;

FIG. 11 is a top, front, and right side perspective view of a third embodiment of FIGS. 1-5 showing our new design;

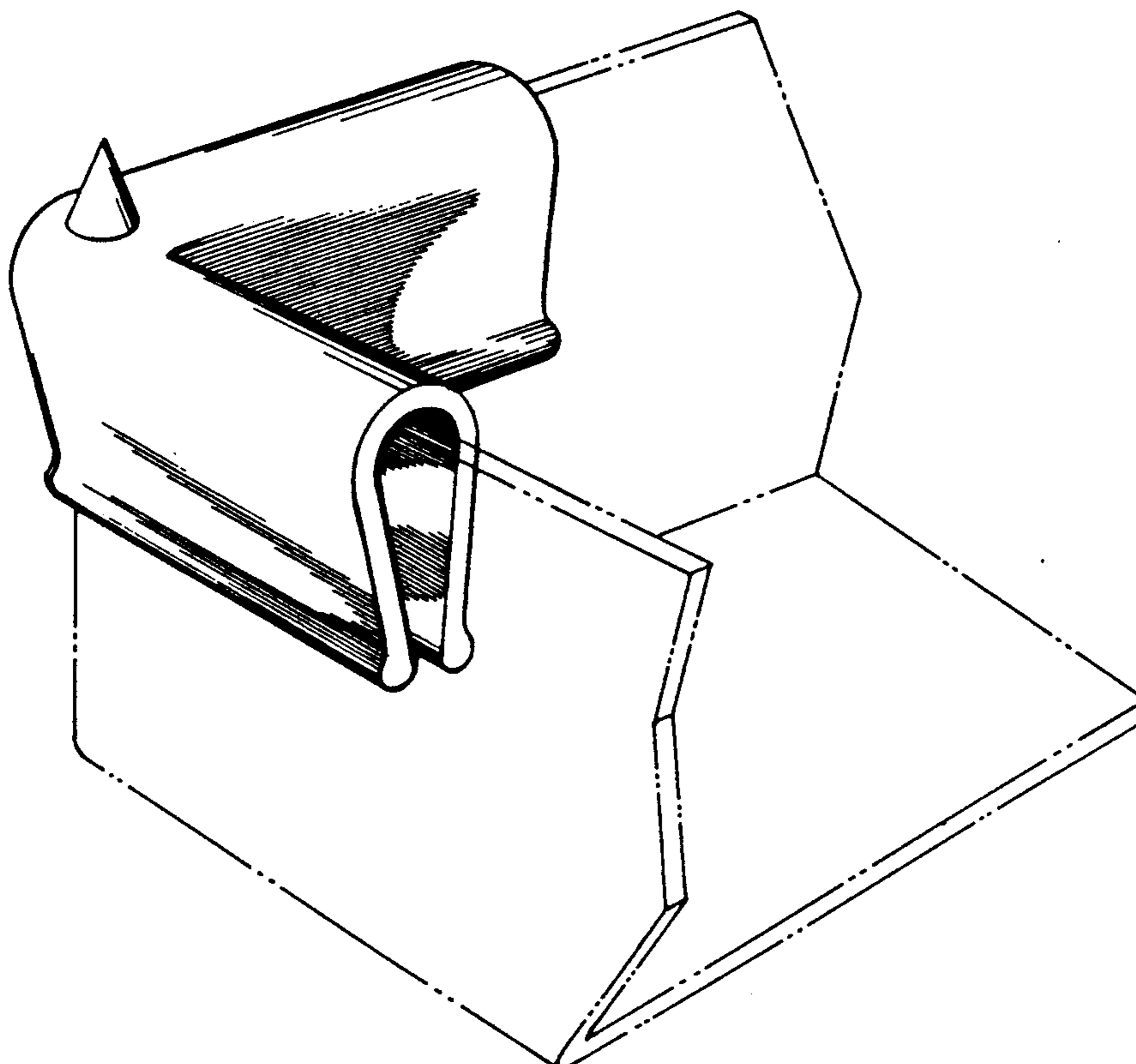
FIG. 12 is a top plan view;

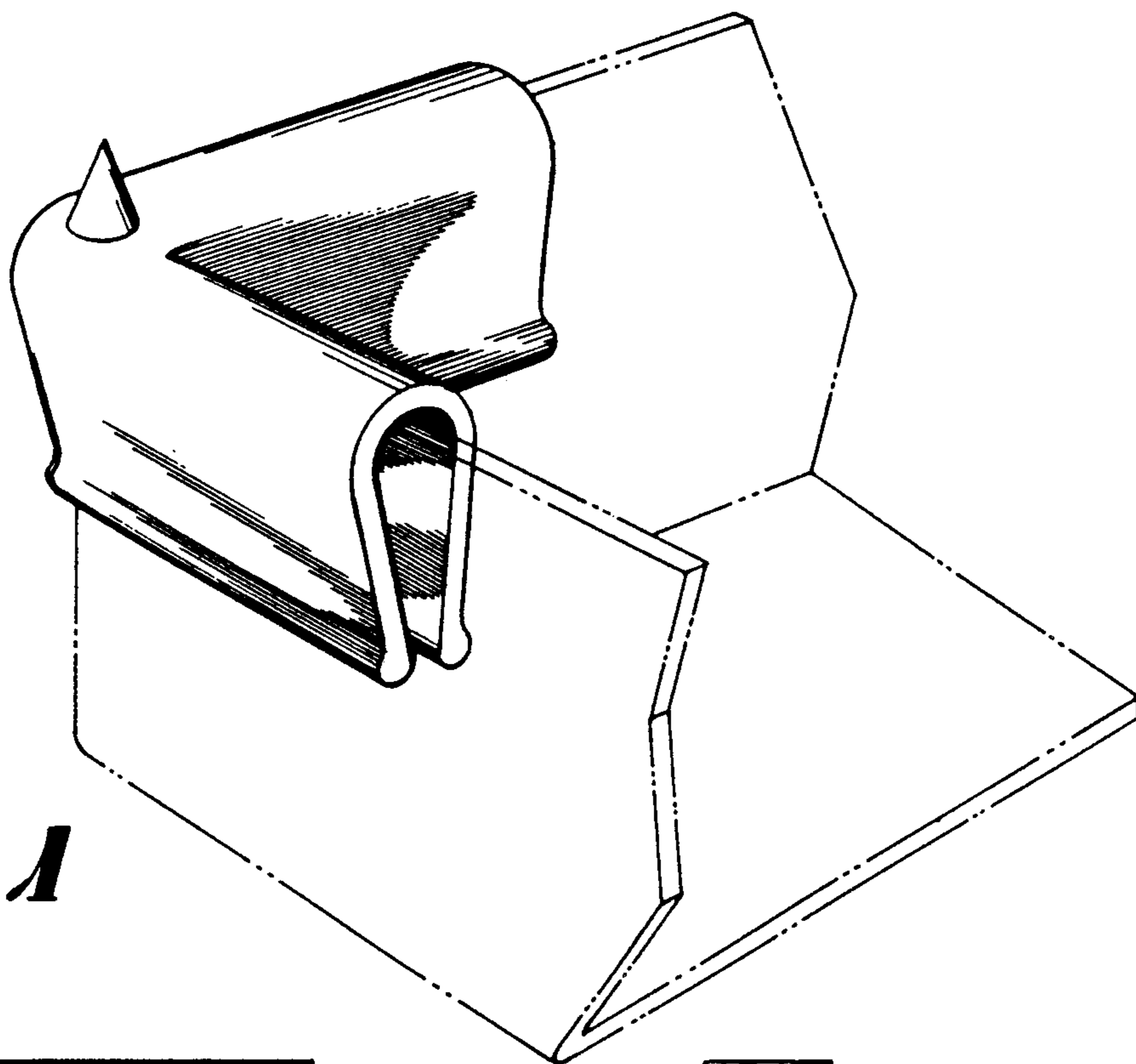
FIG. 13 is a bottom plan view;

FIG. 14 is a right side elevational view;

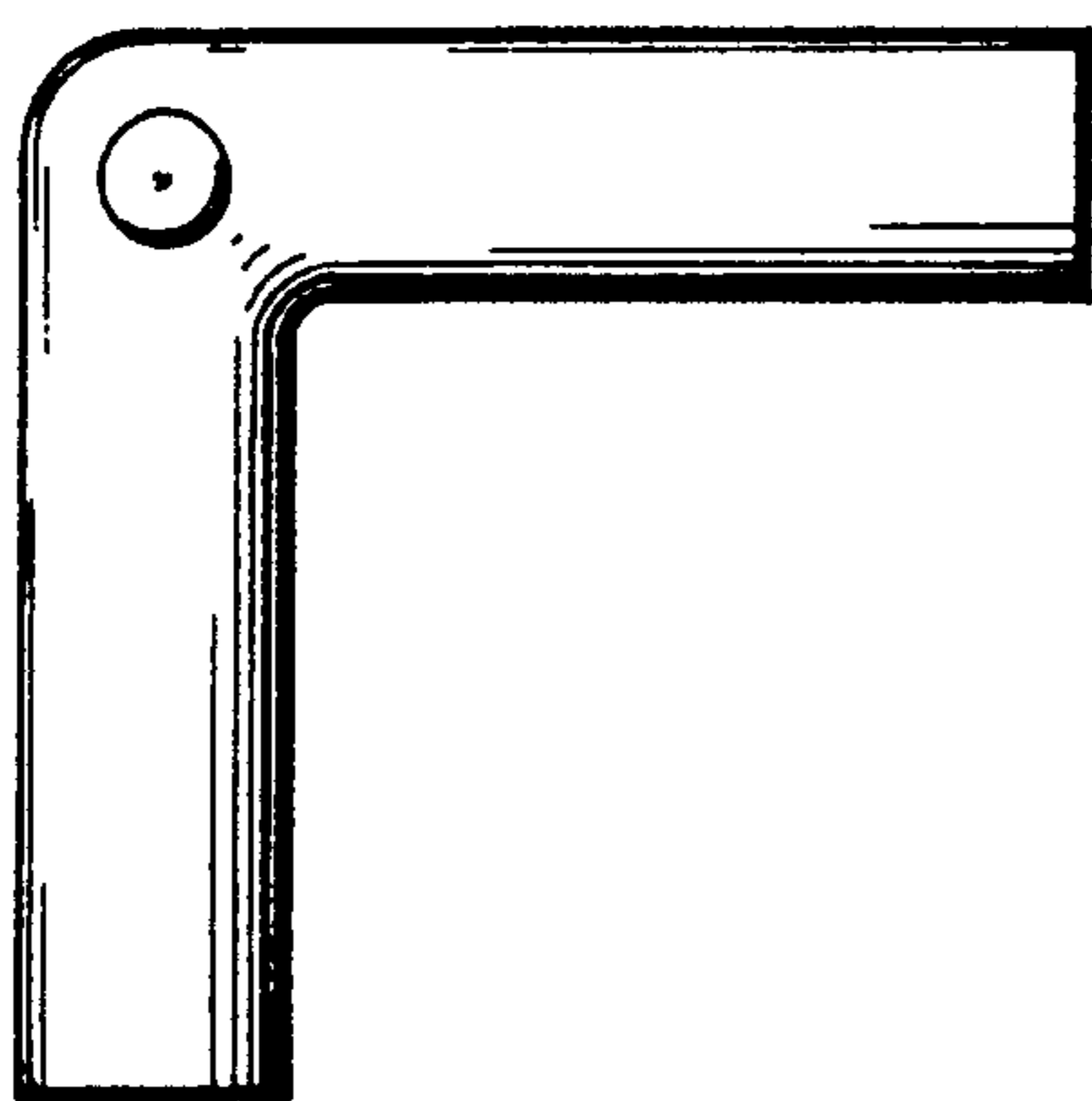
FIG. 15 is a left side elevational view; and

FIG. 16 is a rear elevational view thereof.

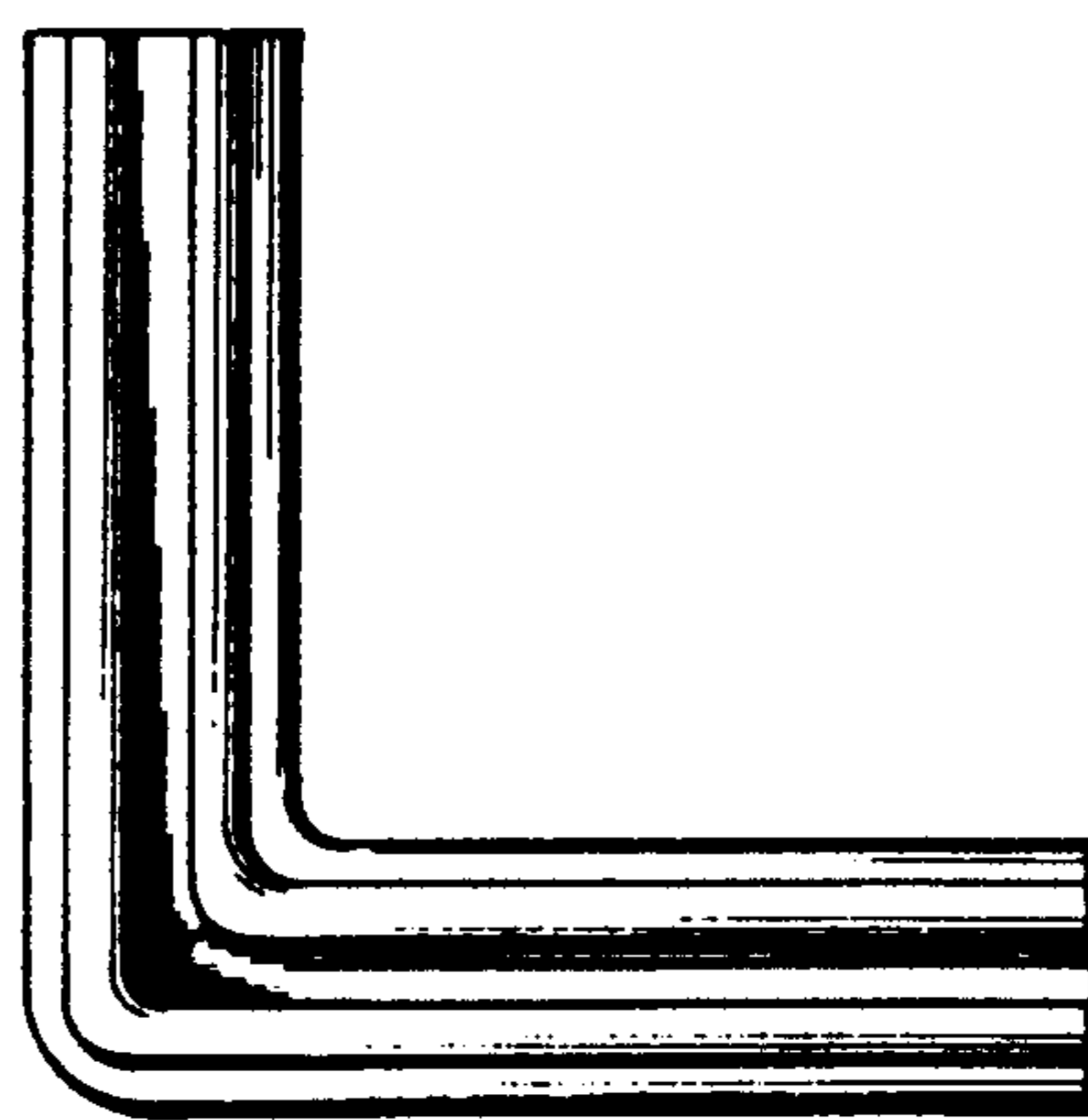




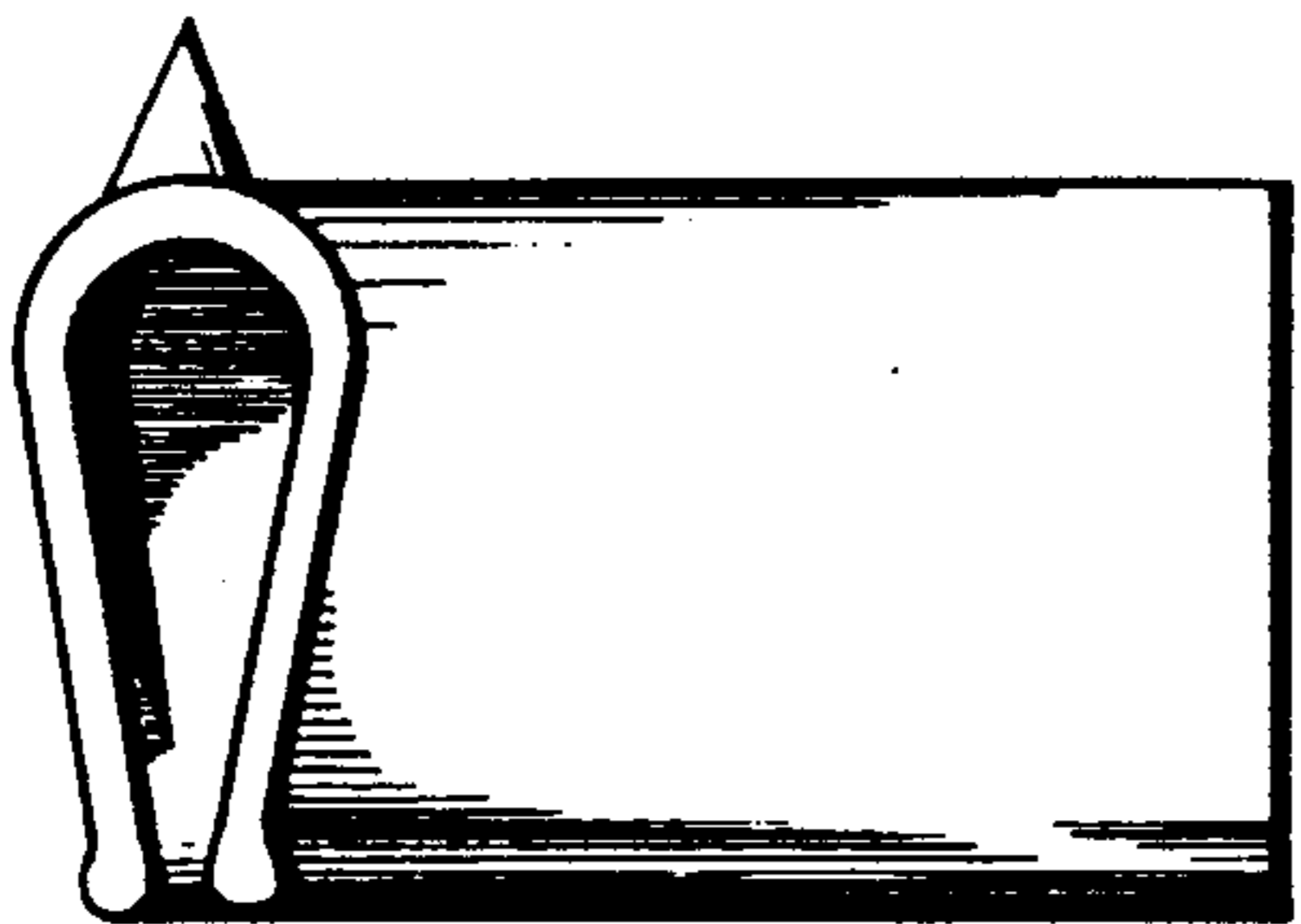
**FIG 1**



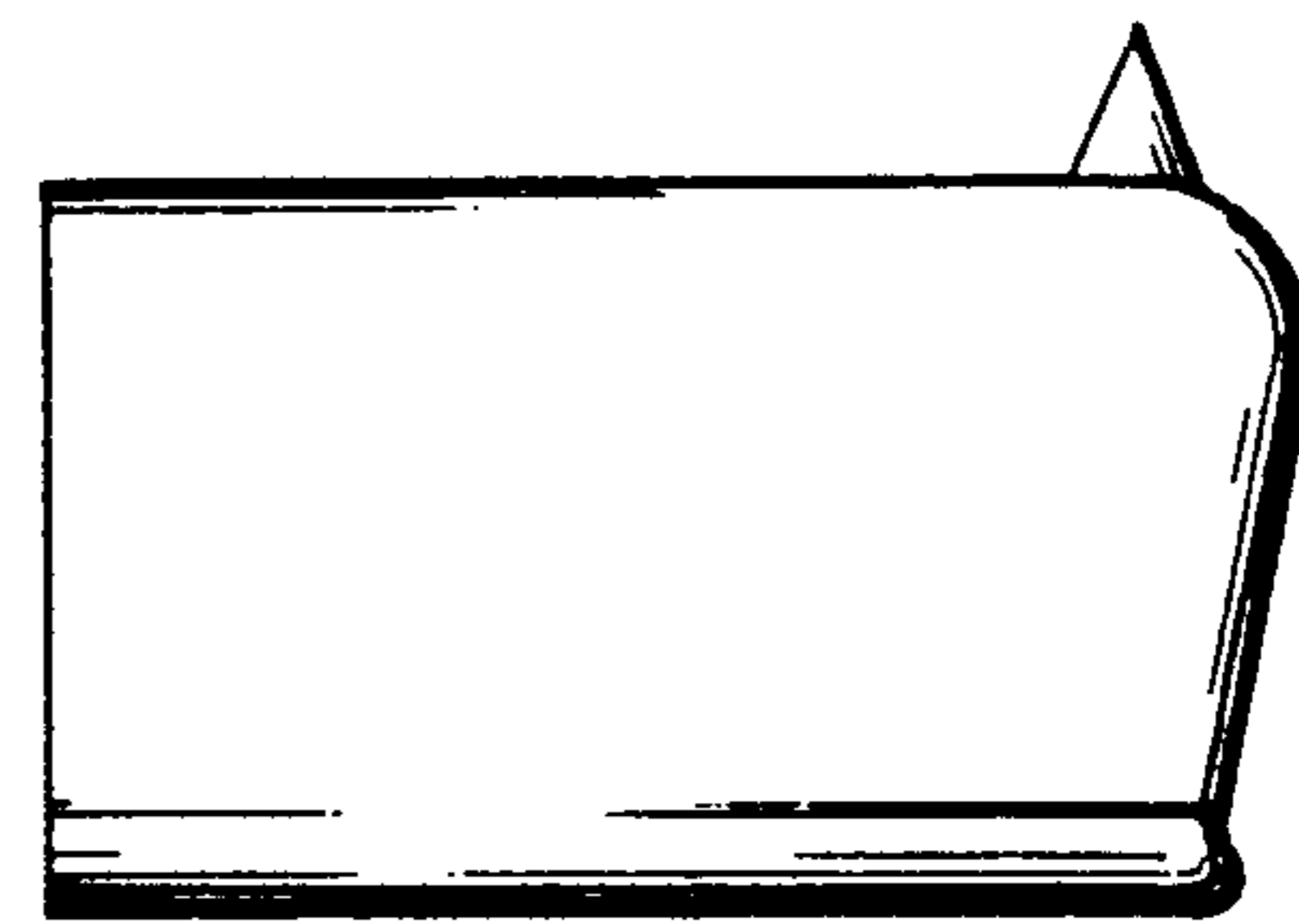
**FIG 2**



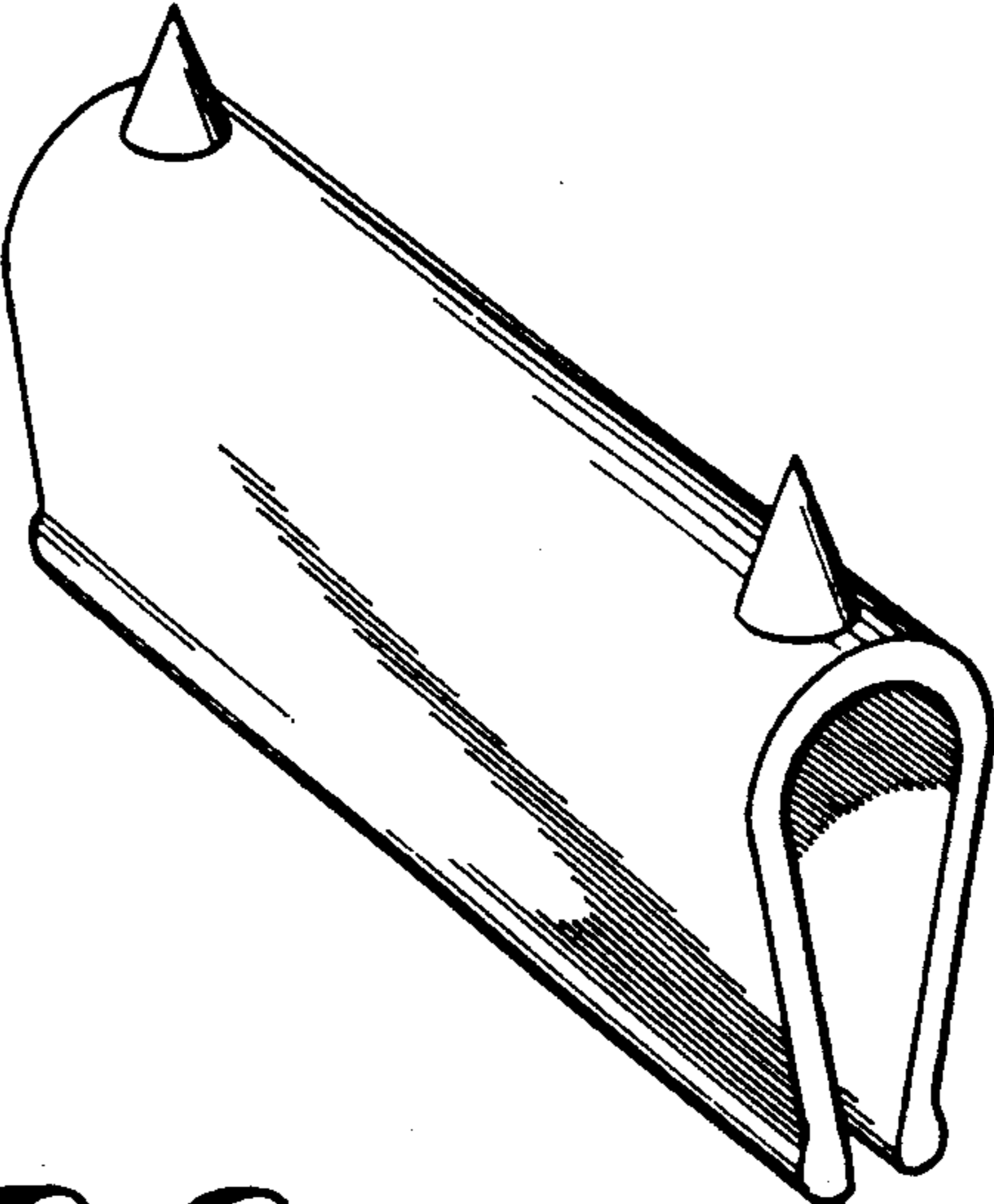
**FIG 3**



**FIG 4**



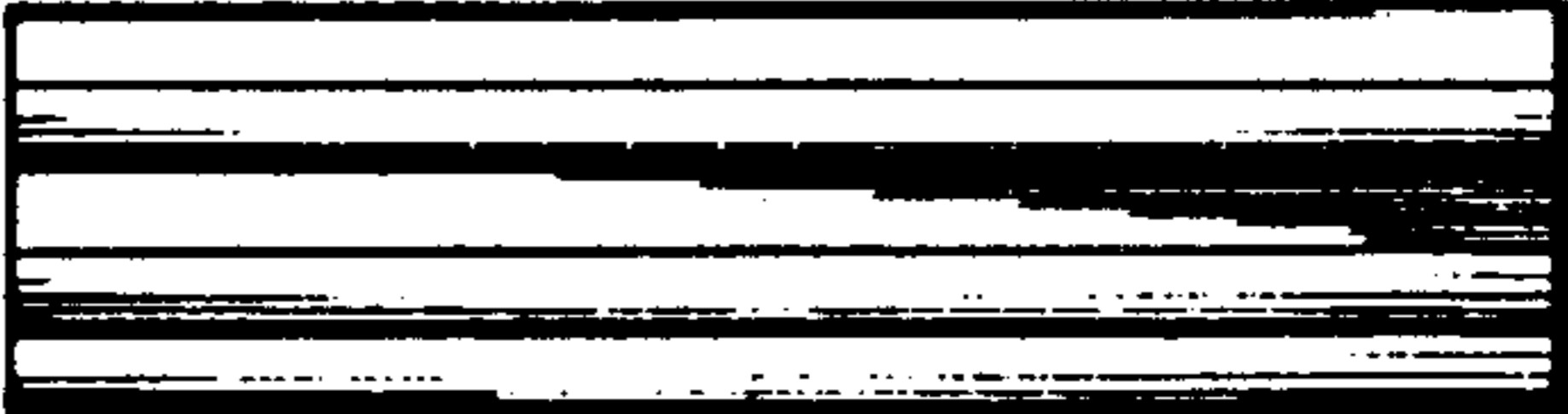
**FIG 5**



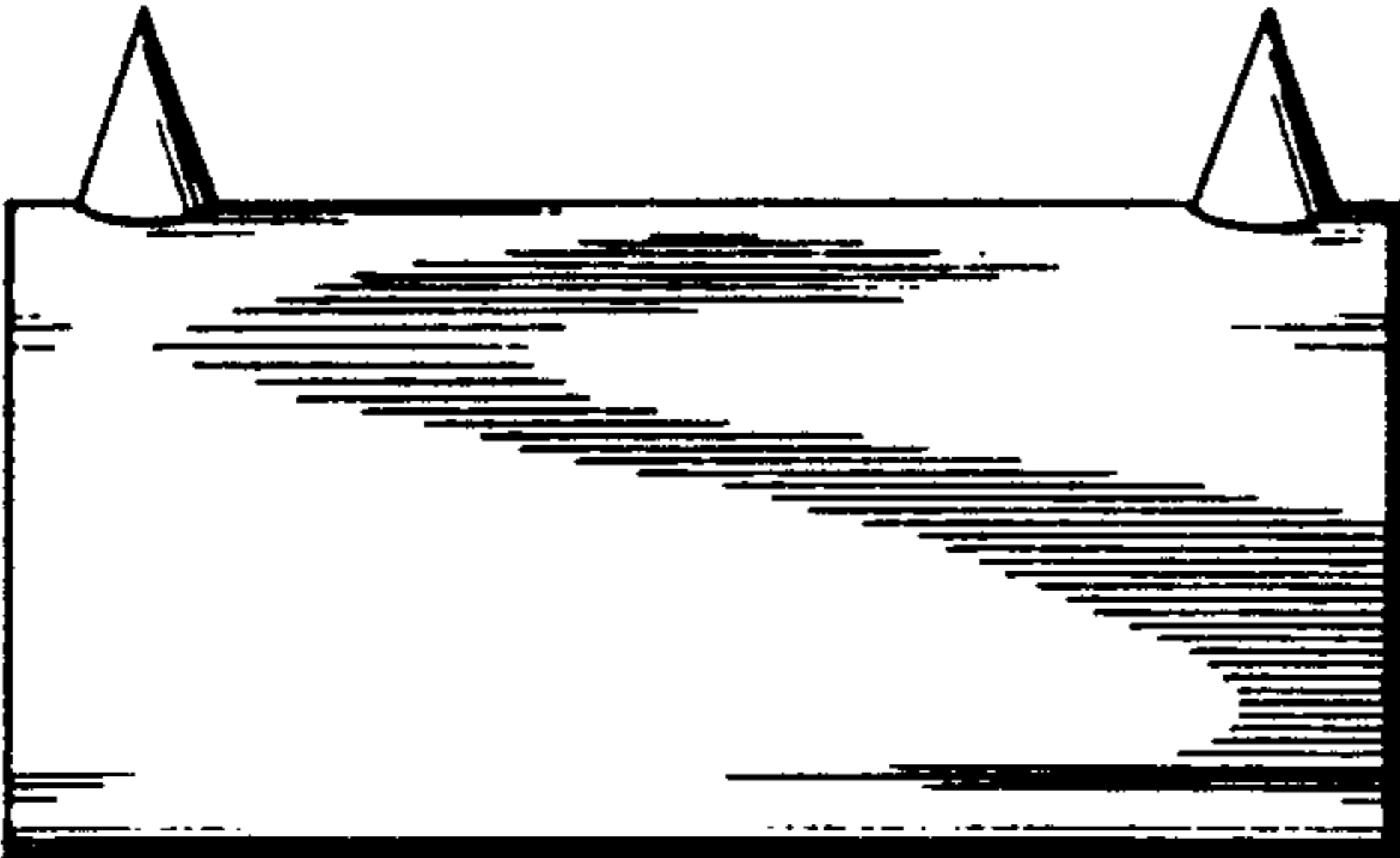
**FIG 6**



**FIG 7**



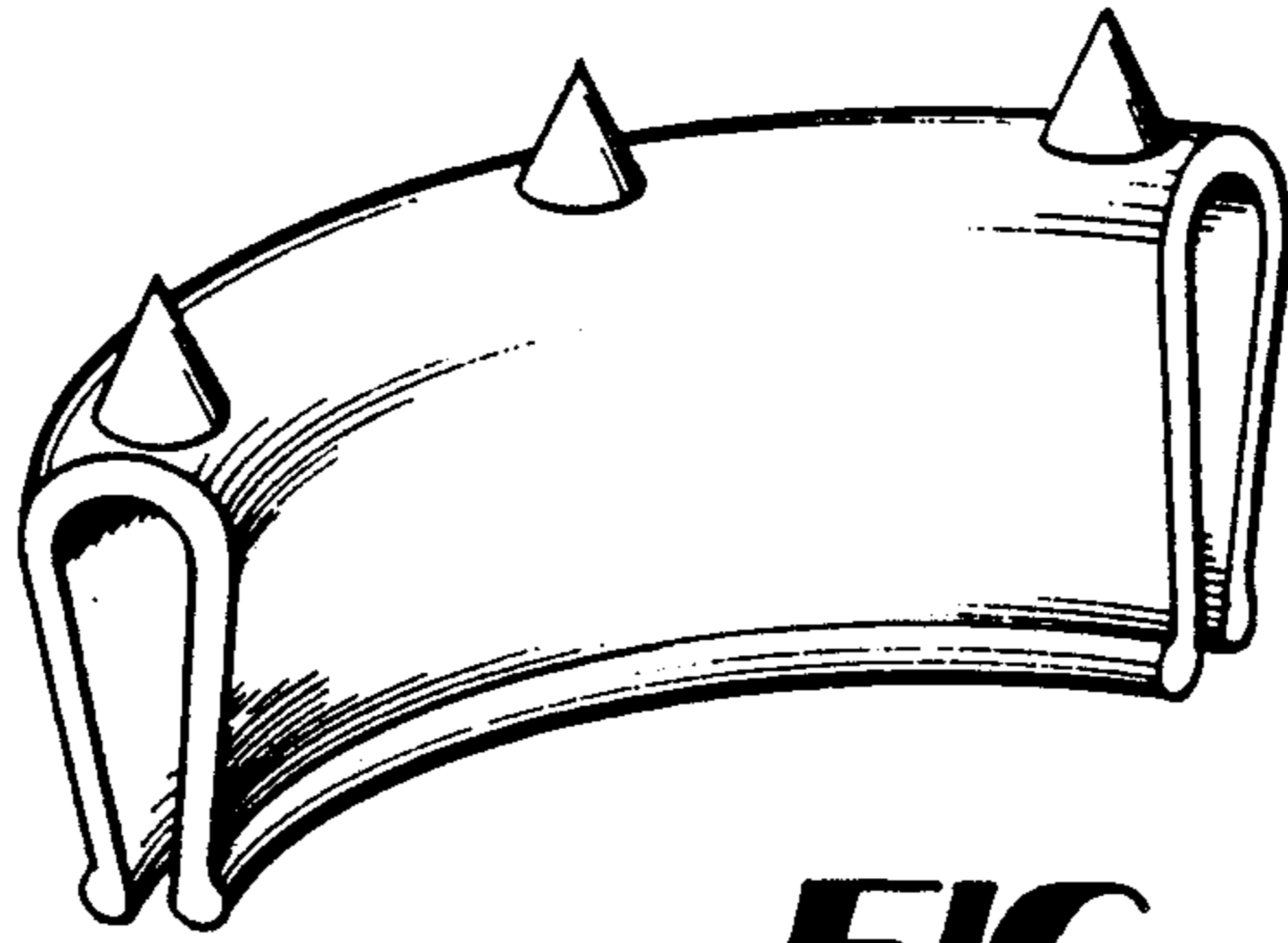
**FIG 8**



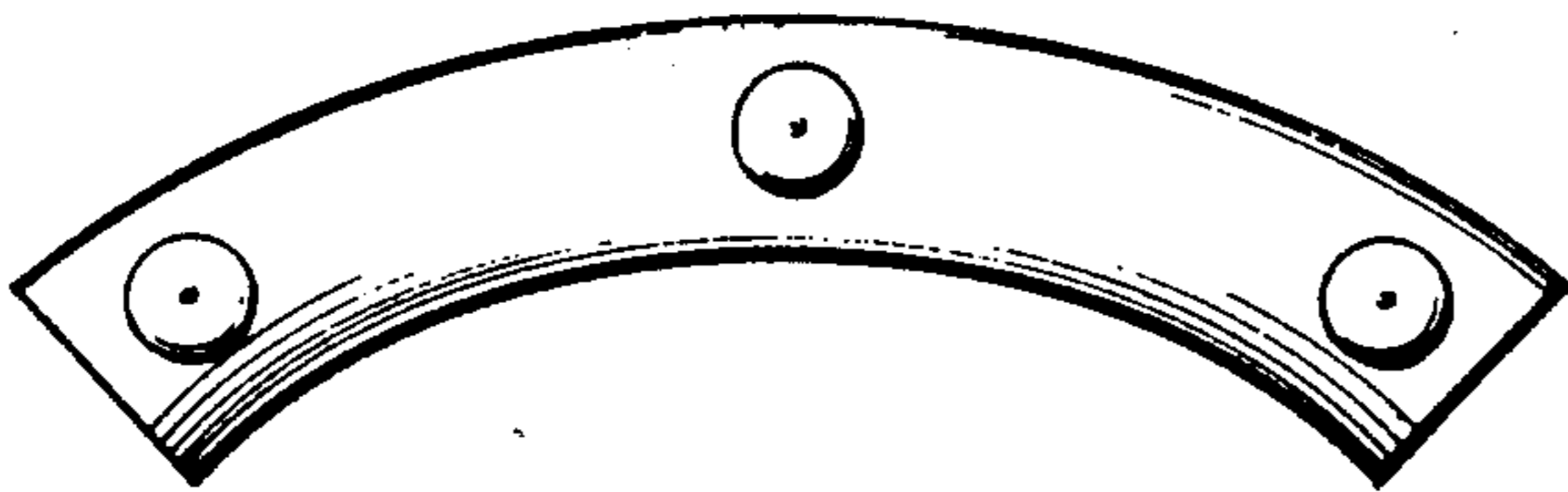
**FIG 9**



**FIG 10**



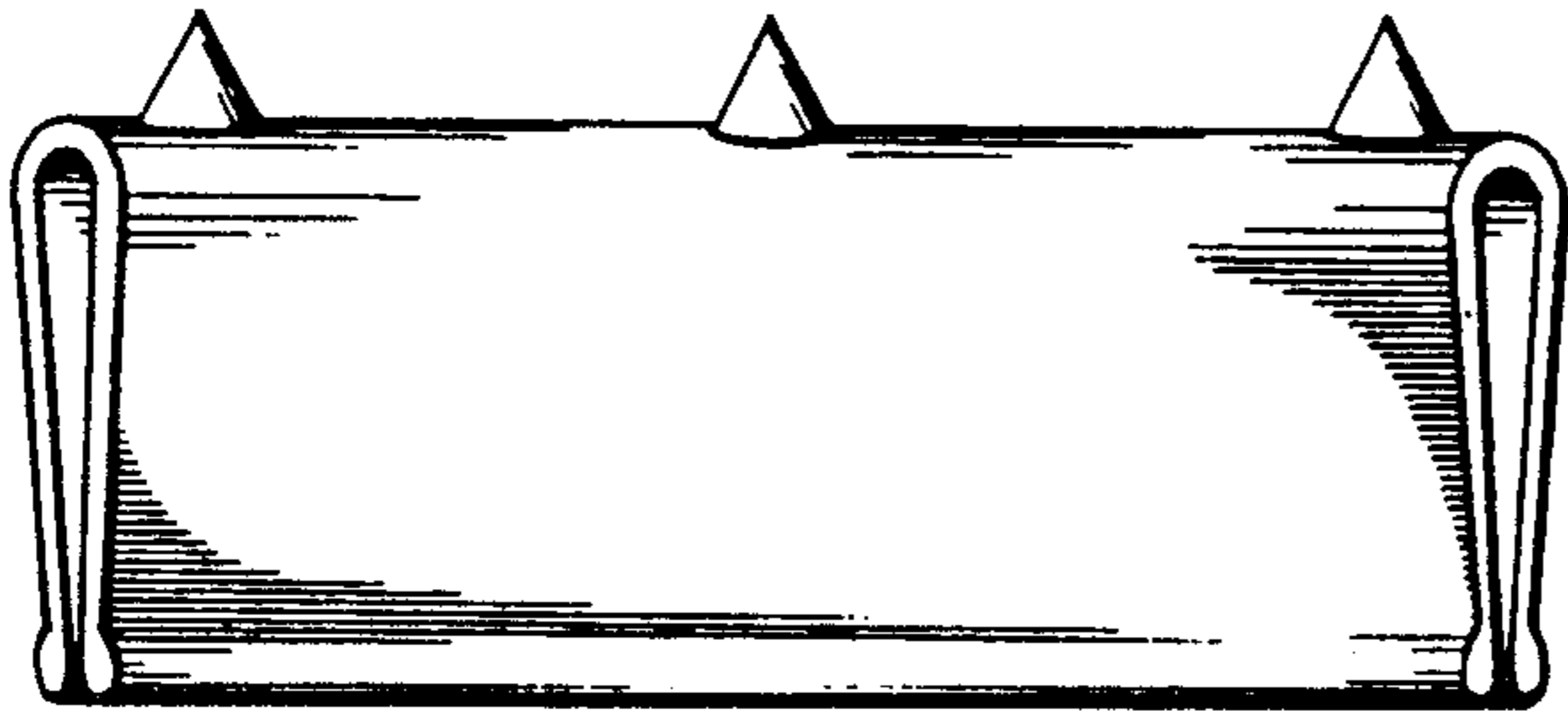
**FIG 11**



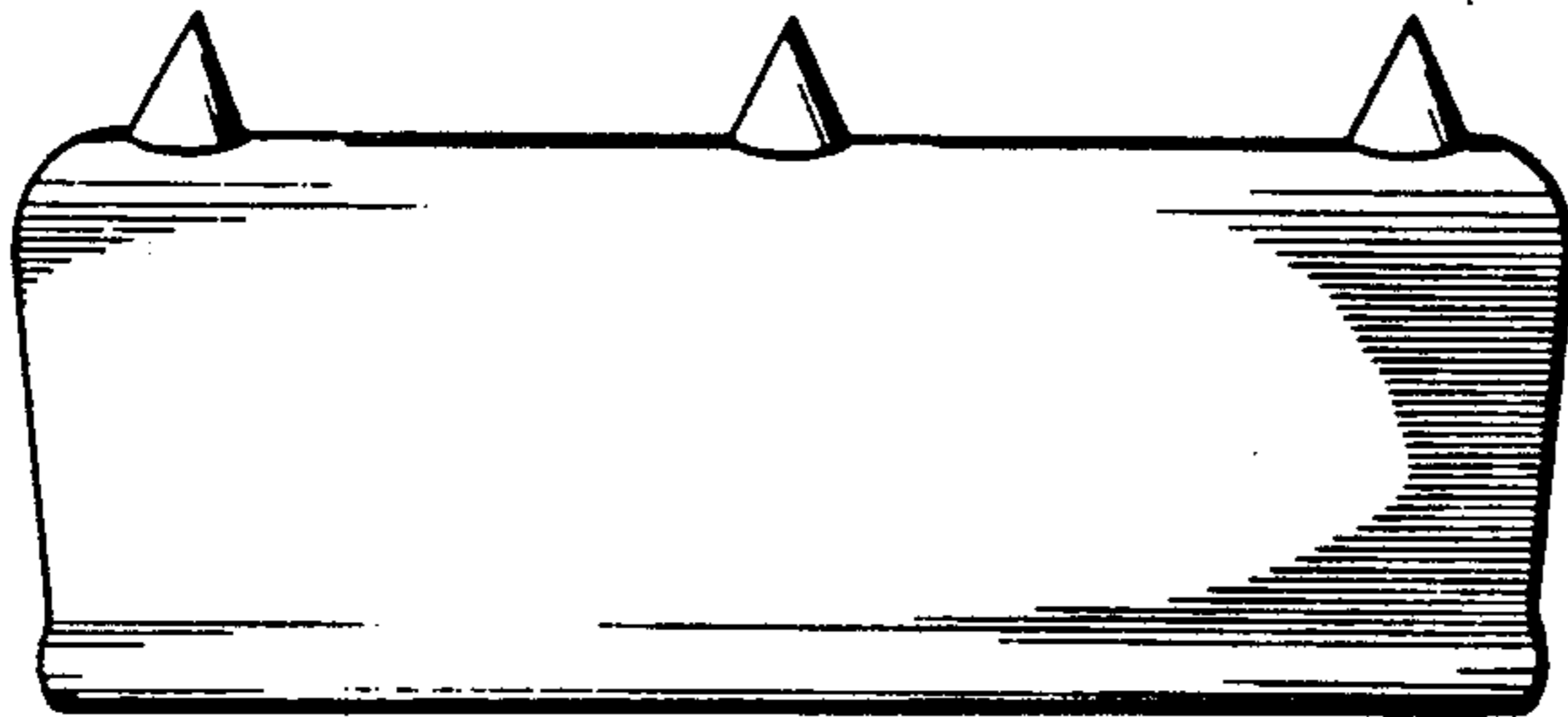
**FIG 12**



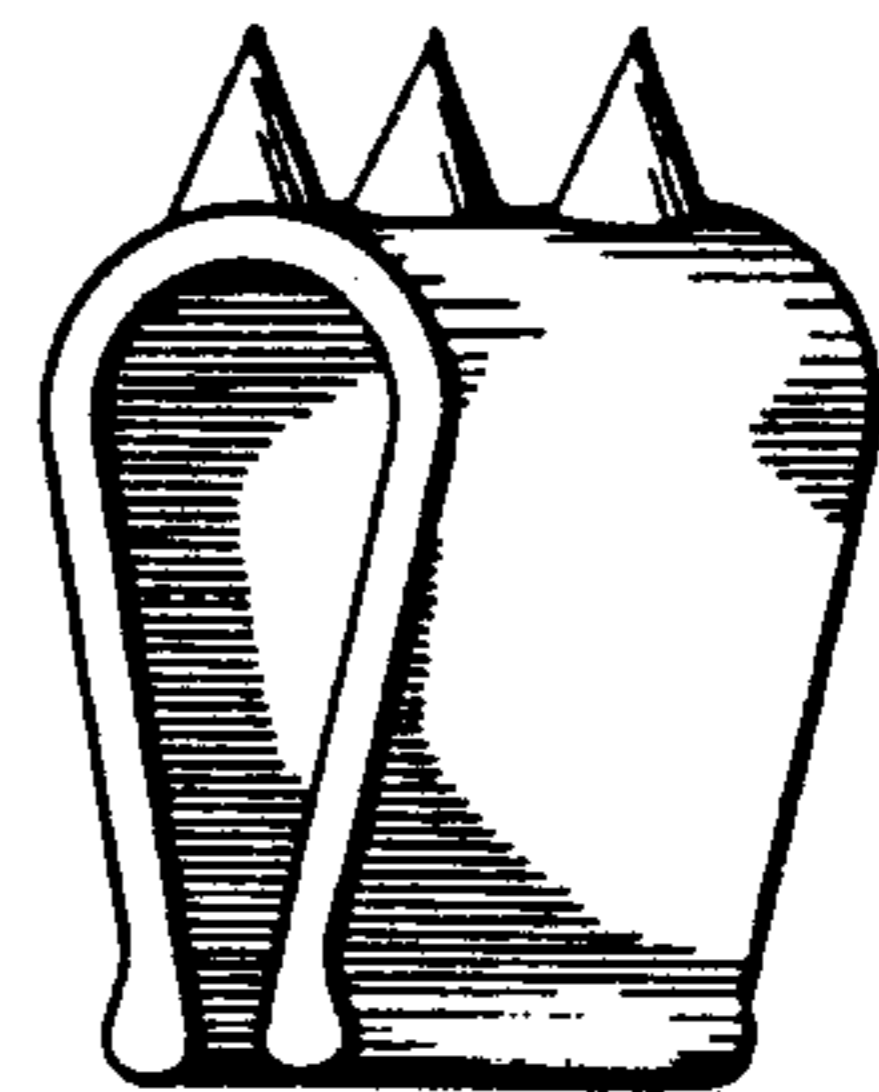
**FIG 13**



**FIG 14**



**FIG 15**



**FIG 16**