

[54] COMBINED AUTOMOBILE SPLASH GUARD AND DISPLAY UNIT

[75] Inventors: Pierre Charet; Duke Kraai, both of Miami, Fla.

[73] Assignee: Rally Manufacturing, Inc., Miami, Fla.

[*] Notice: The portion of the term of this patent subsequent to Jan. 2, 2004 has been disclaimed.

[**] Term: 14 Years

[21] Appl. No.: 151,790

[22] Filed: Feb. 3, 1988

[52] U.S. Cl. D12/185

[58] Field of Search D12/185; 280/851

[56] References Cited

U.S. PATENT DOCUMENTS

D. 281,774 12/1985 Ward D12/185

OTHER PUBLICATIONS

J. C. Whitney Catalog No. 468K, ©1986, p. 136, Ex-

tra-Wide Splash Guards, second box in from bottom right side of page.

J. C. Whitney Catalog No. 468K, ©1986, p. 137, High-Style Splash Guards, top right side of page.

J. C. Whitney Catalog No. 454D, ©1985, p. 112, Colorful Splash Guard A, bottom left side of page.

Primary Examiner—James M. Gandy
Attorney, Agent, or Firm—Longacre & White

[57] CLAIM

The ornamental design for a combined automobile splash guard and display unit, as shown and described.

DESCRIPTION

FIG. 1 is a perspective view of a combined automobile splash guard and display unit showing my new design mounted on the left rear of an automobile which is shown in broken lines for illustrative purposes only and forms no part of the claimed design;

FIG. 2 is an enlarged front elevation view thereof;

FIG. 3 is an enlarged right side elevation view thereof;

FIG. 4 is an enlarged left side elevation view thereof;

FIG. 5 is an enlarged rear elevation view thereof; and

FIG. 6 is an enlarged bottom plan view thereof.

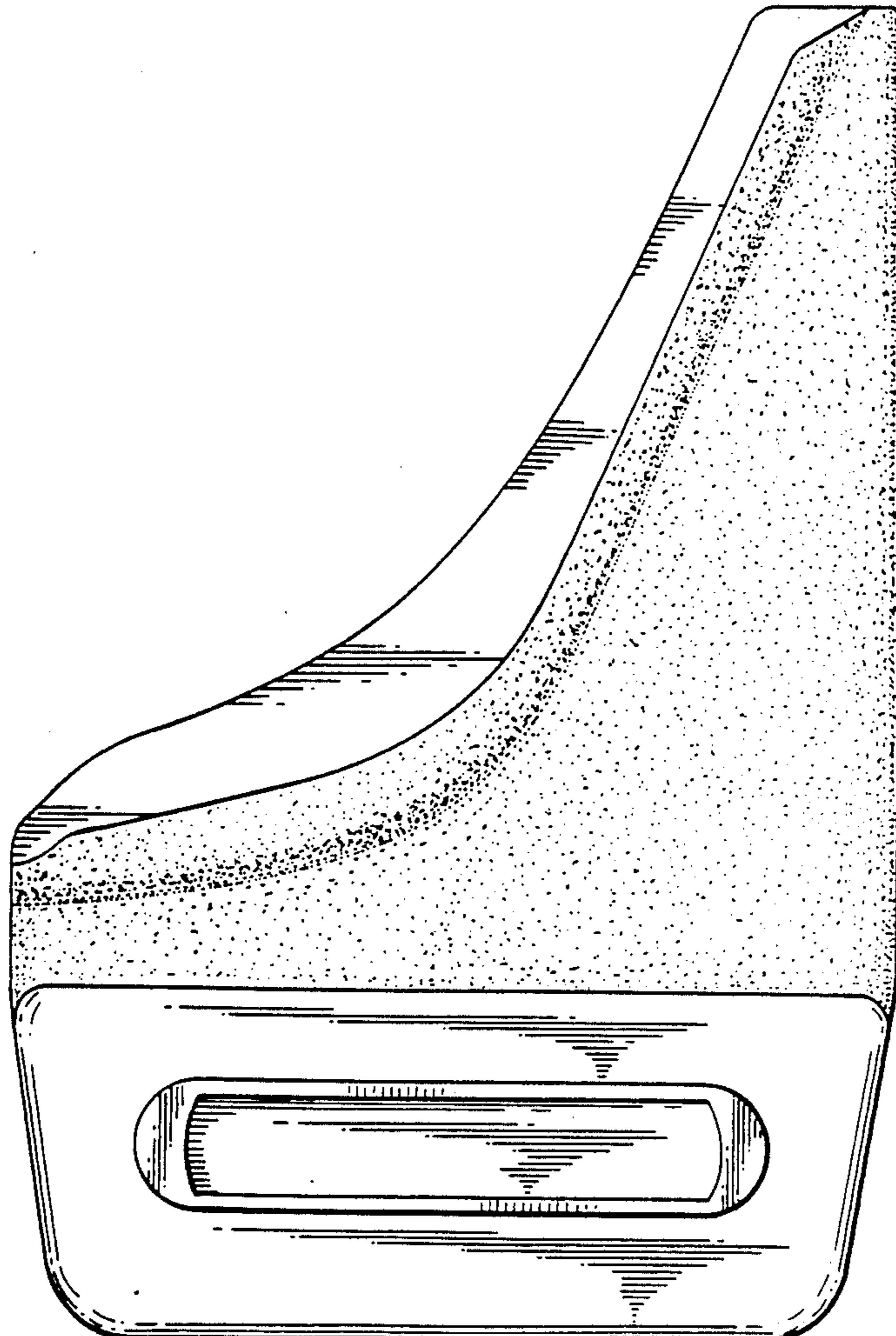

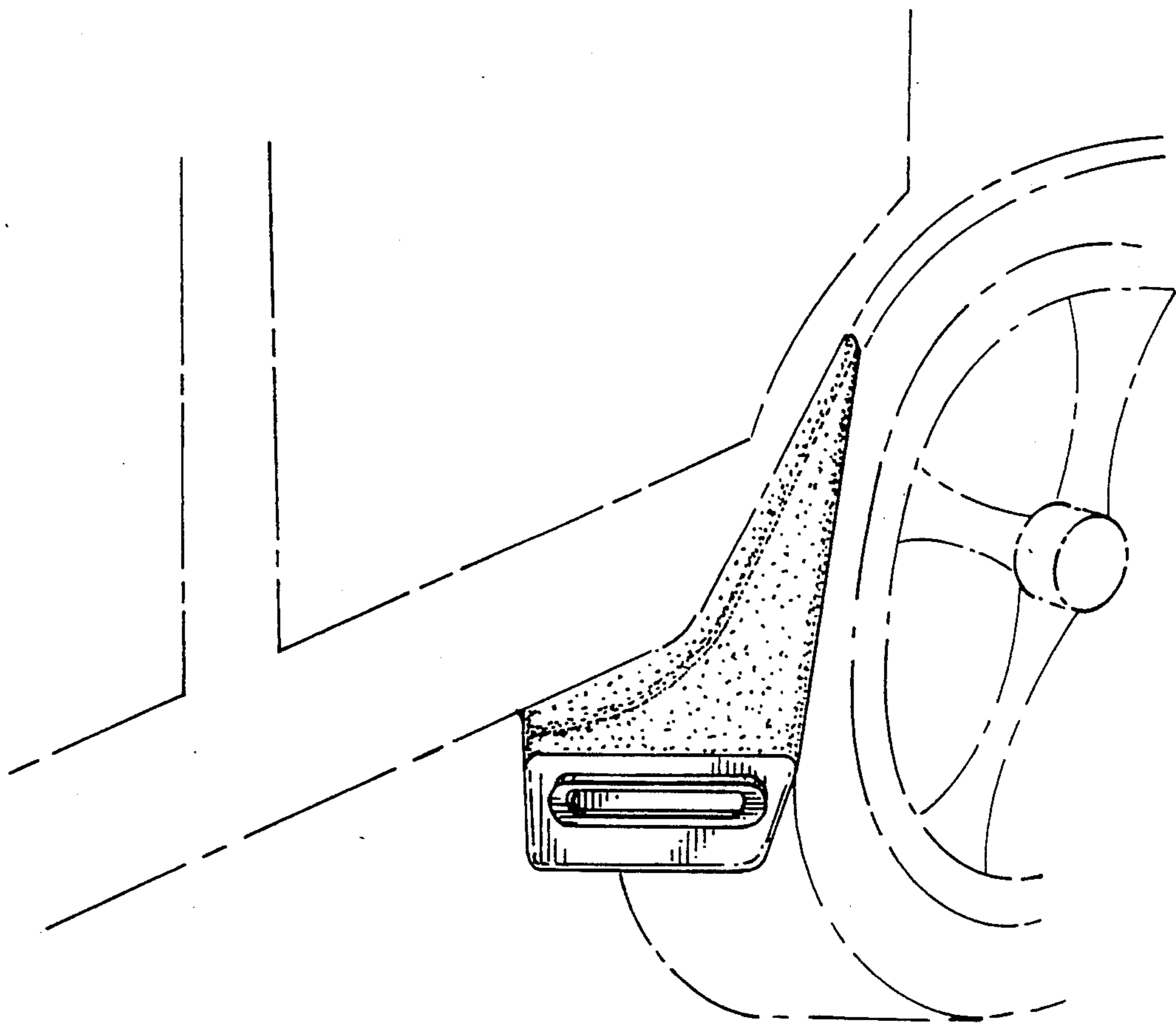

FIG. 1

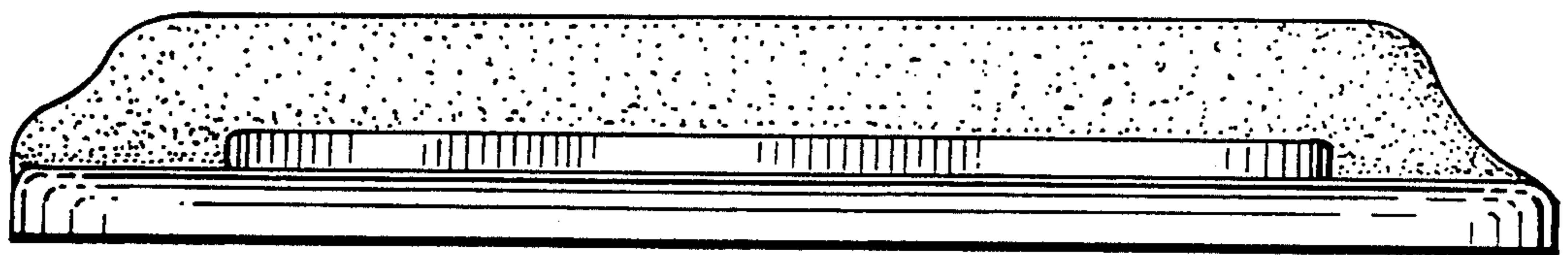
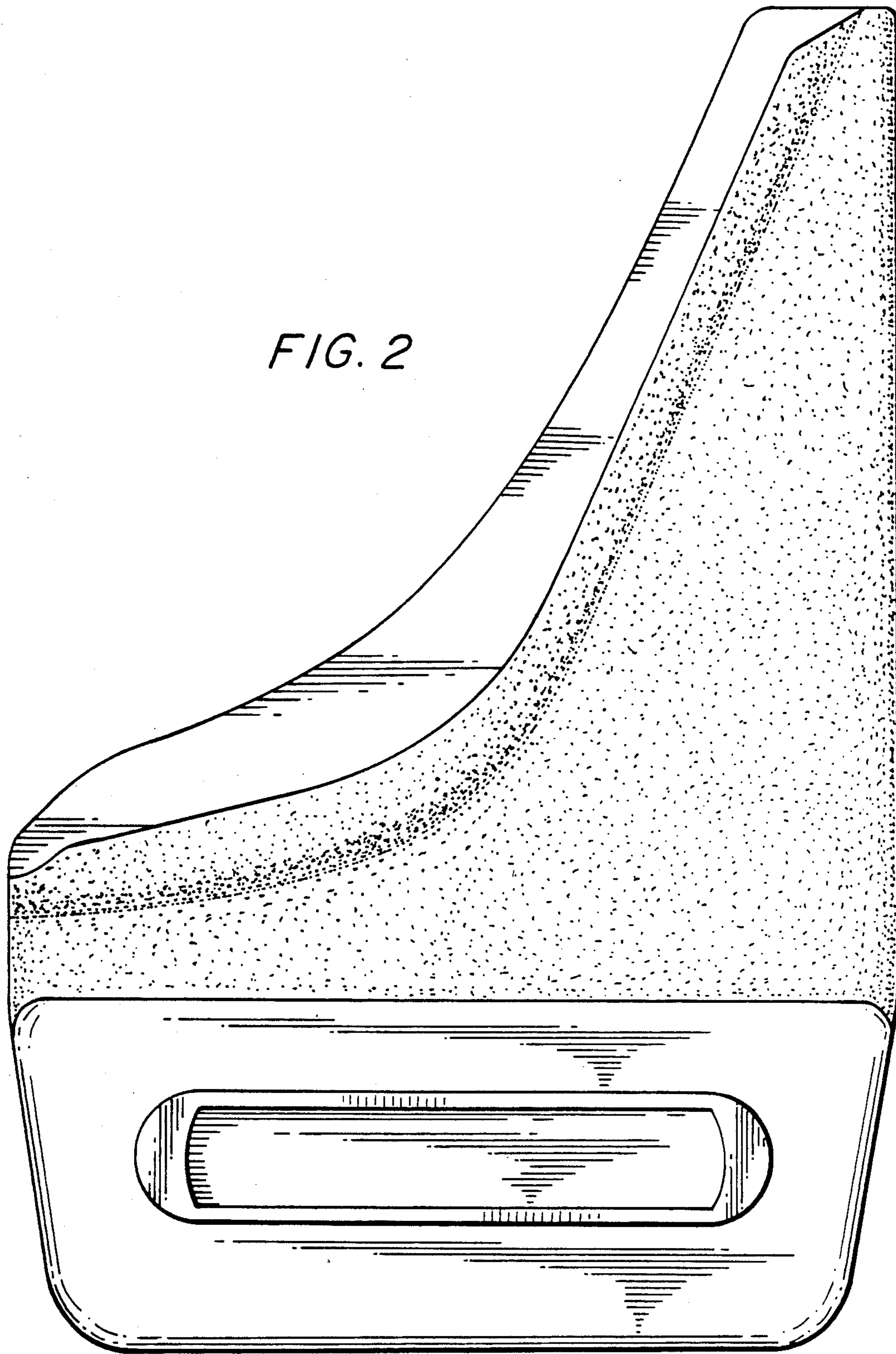

FIG. 6

FIG. 2



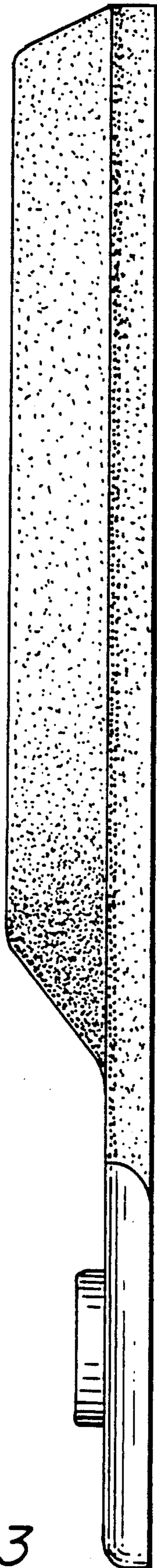

FIG. 3

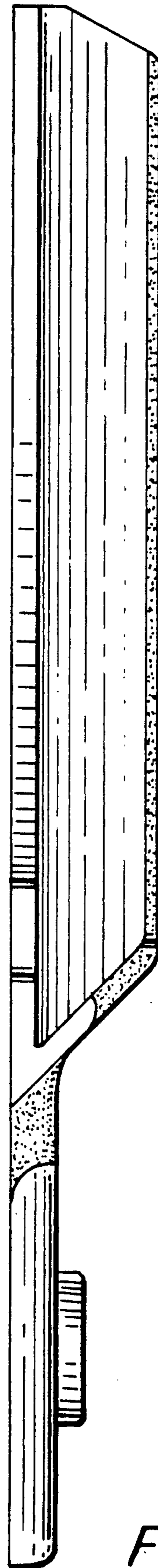

FIG. 4

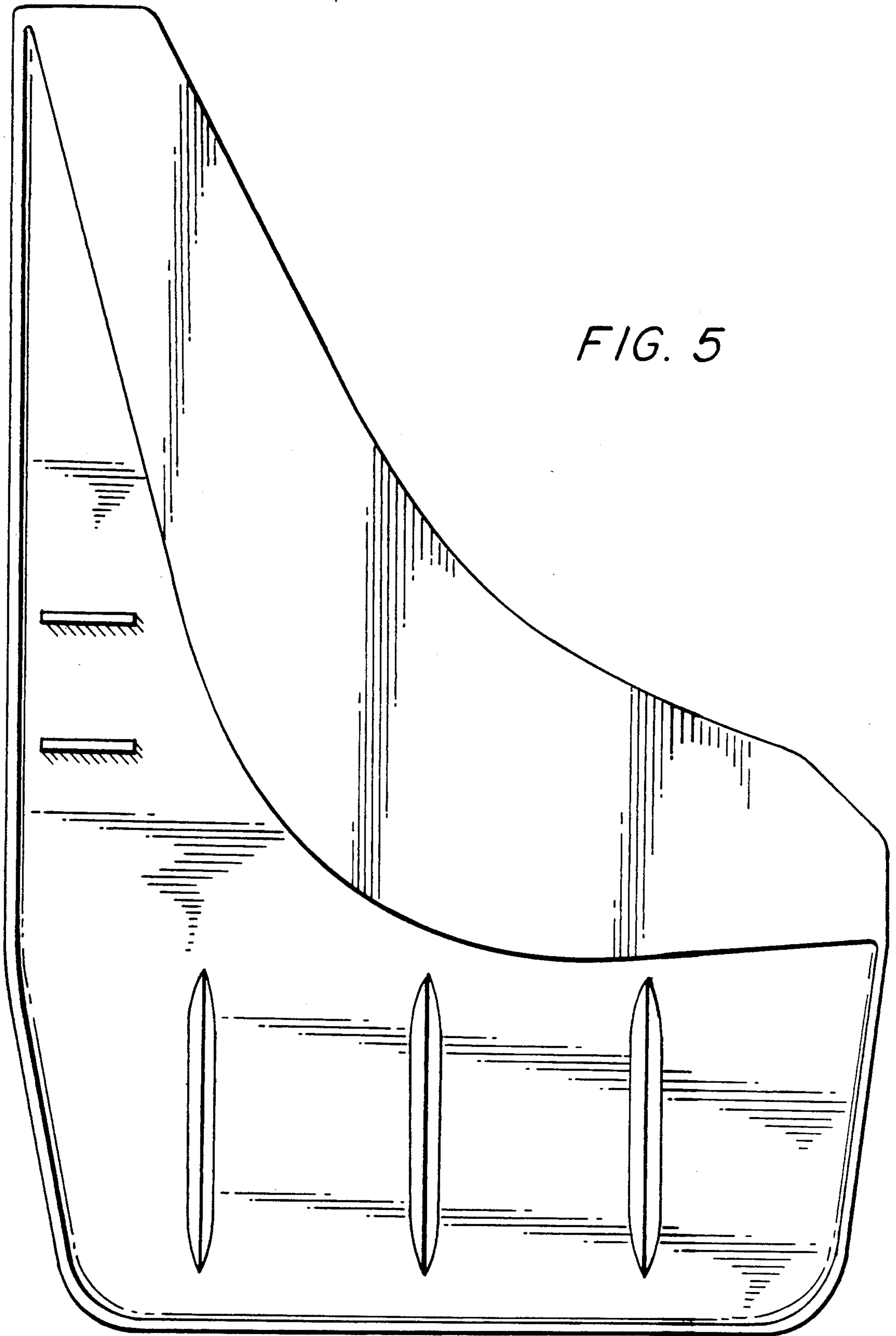

FIG. 5