

[54] DOOR HARDWARE

[75] Inventor: Michael J. Tremonti, Hawthorne, N.J.

[73] Assignee: Hardware Designs Inc., Fairfield, N.J.

[**] Term: 14 Years

[21] Appl. No.: 275,030

[22] Filed: Nov. 22, 1988

[52] U.S. Cl. D8/319; D8/316

[58] Field of Search D8/300, 301, 315-320, D8/302; 16/110 R, 111 R, 121, 124, 125

[56] References Cited

U.S. PATENT DOCUMENTS

- D. 80,748 3/1930 Schlage D8/302
- D. 85,601 11/1931 Sherman D8/316
- D. 162,516 3/1951 Burgold D8/316

Primary Examiner—B. J. Bullock
Attorney, Agent, or Firm—Blum Kaplan

[57] CLAIM

The ornamental design for door hardware, as shown and described.

DESCRIPTION

FIG. 1 is a perspective view of a door hardware showing my new design;

FIG. 2 is a front elevational view thereof;

FIG. 3 is a top plan view thereof, the bottom plan view being a mirror image;

FIG. 4 is a right side elevational view thereof;

FIG. 5 is a rear elevational view thereof;

FIG. 6 is a left side elevational view thereof;

FIG. 7 is a top plan view of a second embodiment of the design of FIG. 1, the only difference being the inclusion of the mirror image of the design in a paired arrangement;

FIG. 8 is a front elevational view of FIG. 7.

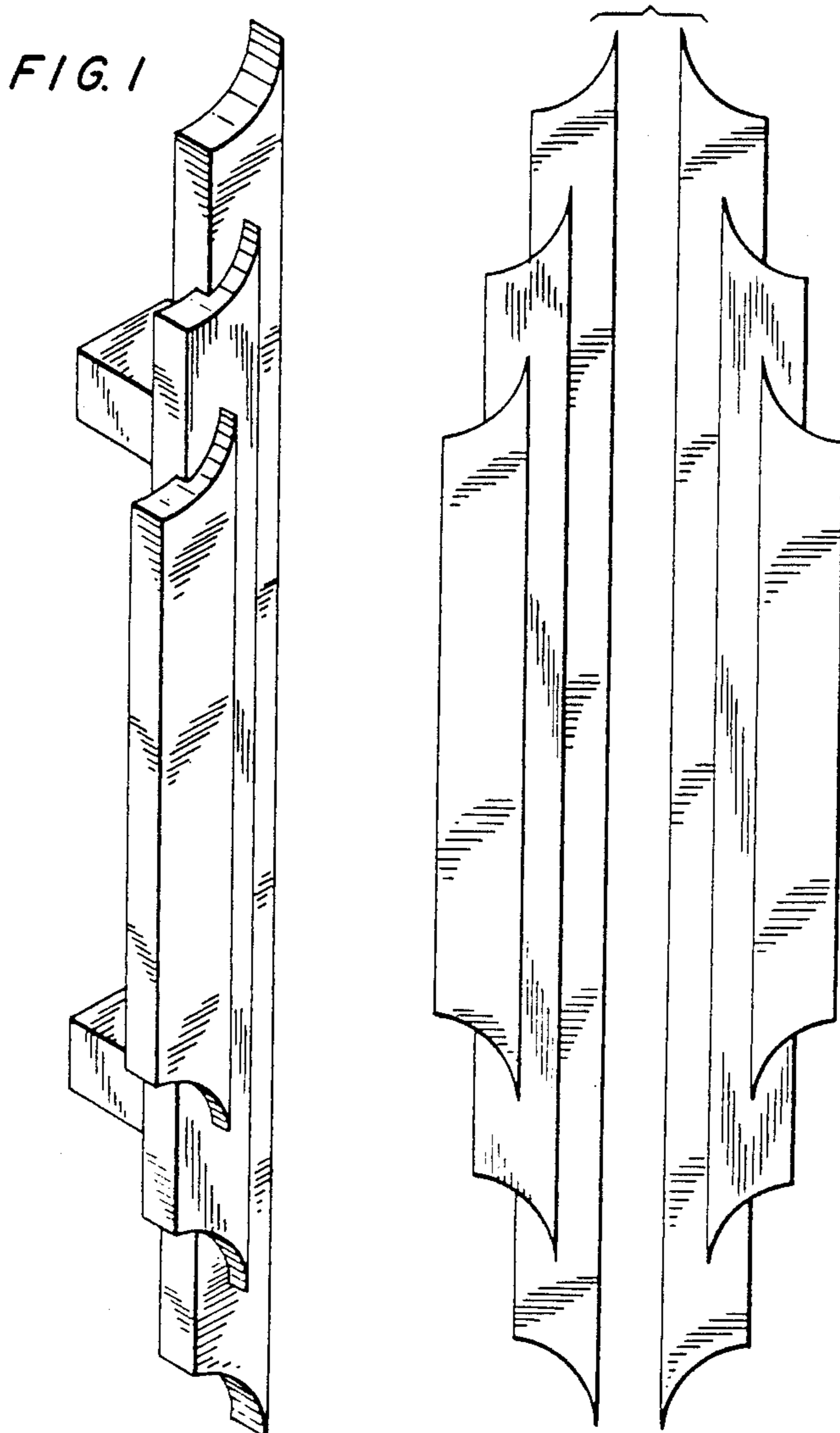

FIG. 1

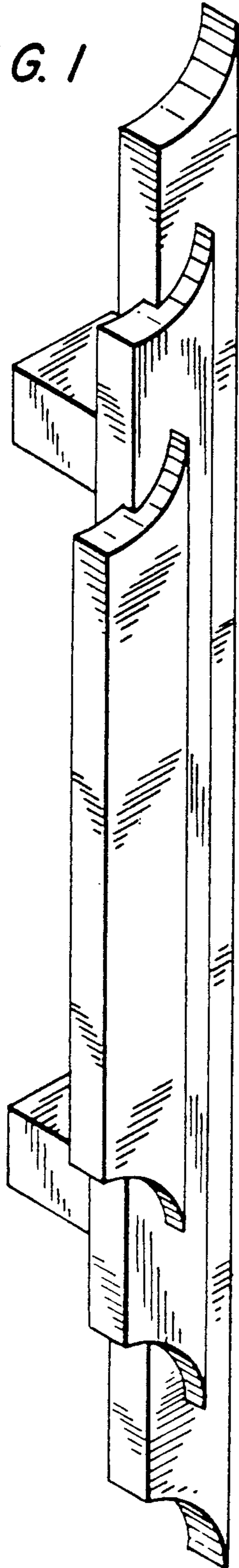

FIG. 2

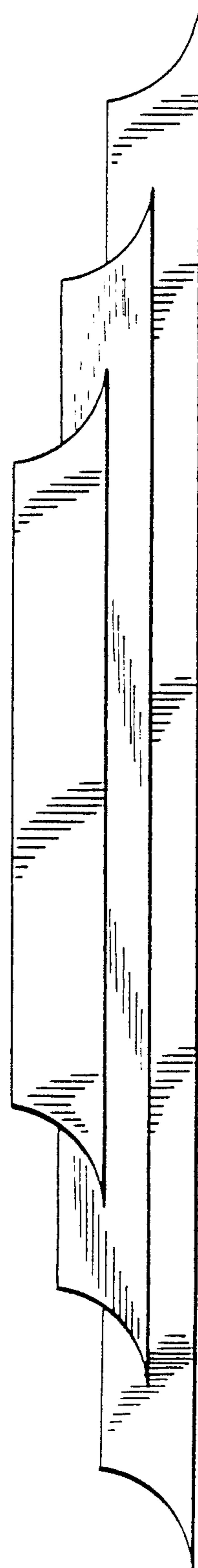

FIG. 3

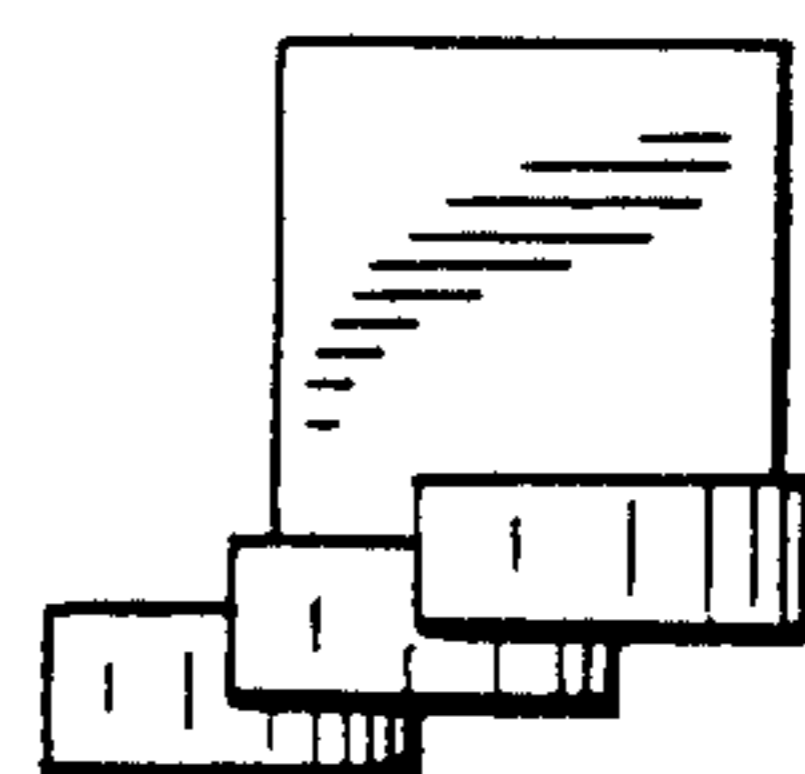

FIG. 4

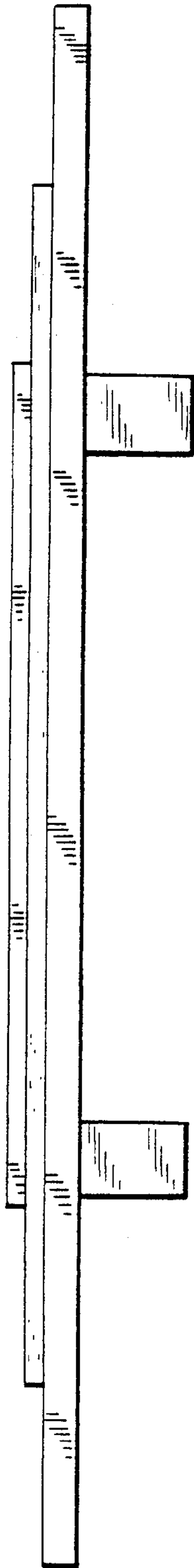

FIG. 5

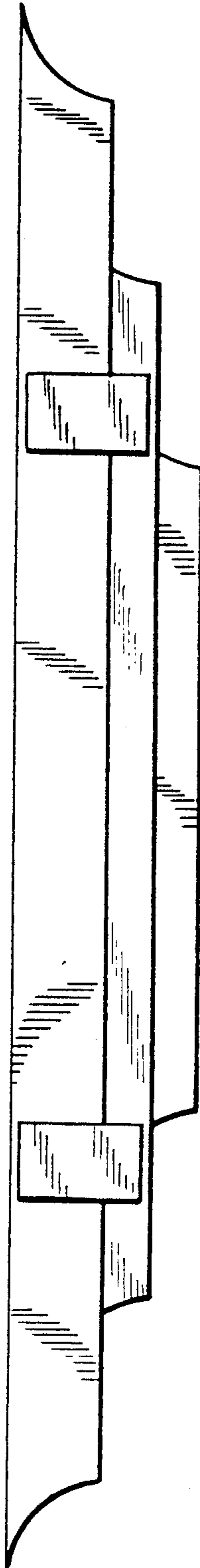

FIG. 6

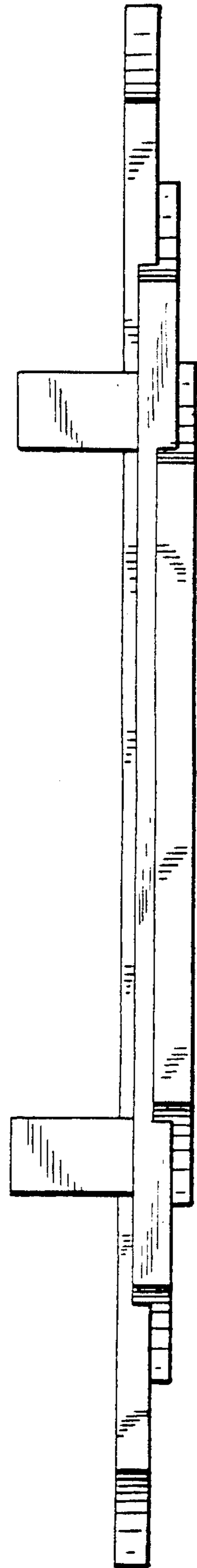

FIG. 7

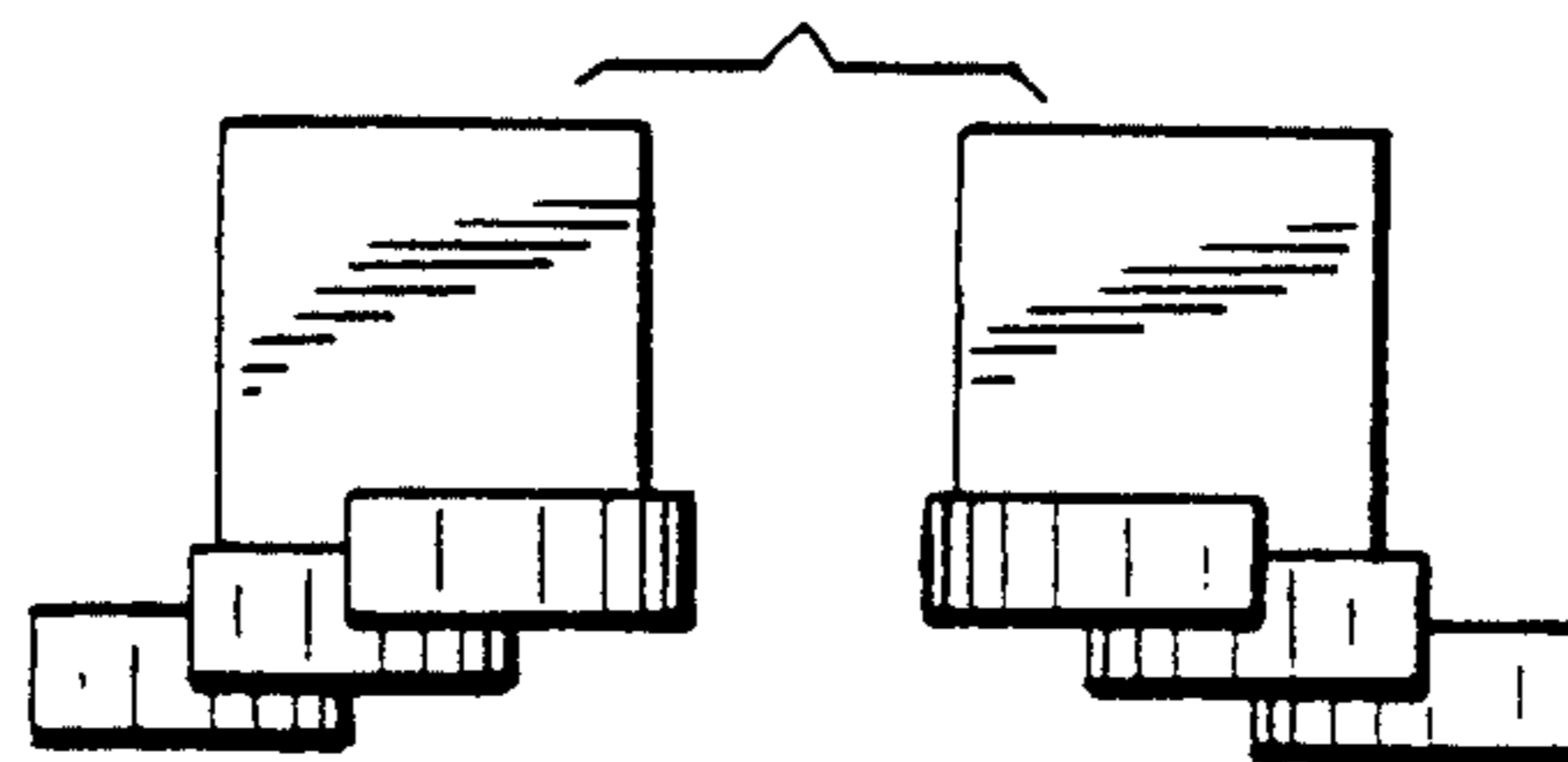

FIG. 8

