

United States Patent [19]
Naft

[11] **Patent Number: Des. 315,080**

[45] **Date of Patent: ** Mar. 5, 1991**

[54] **ELECTRIC MIXER**

[75] **Inventor: Stuart Naft, Stratford, Conn.**

[73] **Assignee: Black & Decker Inc., Newark, Del.**

[**] **Term: 14 Years**

[21] **Appl. No.: 226,392**

[22] **Filed: Jul. 29, 1988**

[52] **U.S. Cl. D7/379**

[58] **Field of Search D7/379, 414, 372, 412,
D7/413, 415, 378, 376**

[56] **References Cited**

U.S. PATENT DOCUMENTS

- D. 207,859 6/1967 Weiss D7/379
- D. 220,883 6/1971 Steinkamp D7/379

- D. 222,756 12/1971 Dykes D7/379
- D. 309,079 7/1990 Petrie et al. D7/379

Primary Examiner—Winifred E. Herrmann
Attorney, Agent, or Firm—Barry E. Deutsch

[57] **CLAIM**

The ornamental design for an electric mixer, as shown and described.

DESCRIPTION

FIG. 1 is a top, front, and right side perspective view of an electric mixer showing my new design;
FIG. 2 is a right side elevational view, the side opposite being a mirror image;
FIG. 3 is a top plan view;
FIG. 4 is a front elevational view;
FIG. 5 is a rear elevational view; and
FIG. 6 is a bottom plan view thereof.

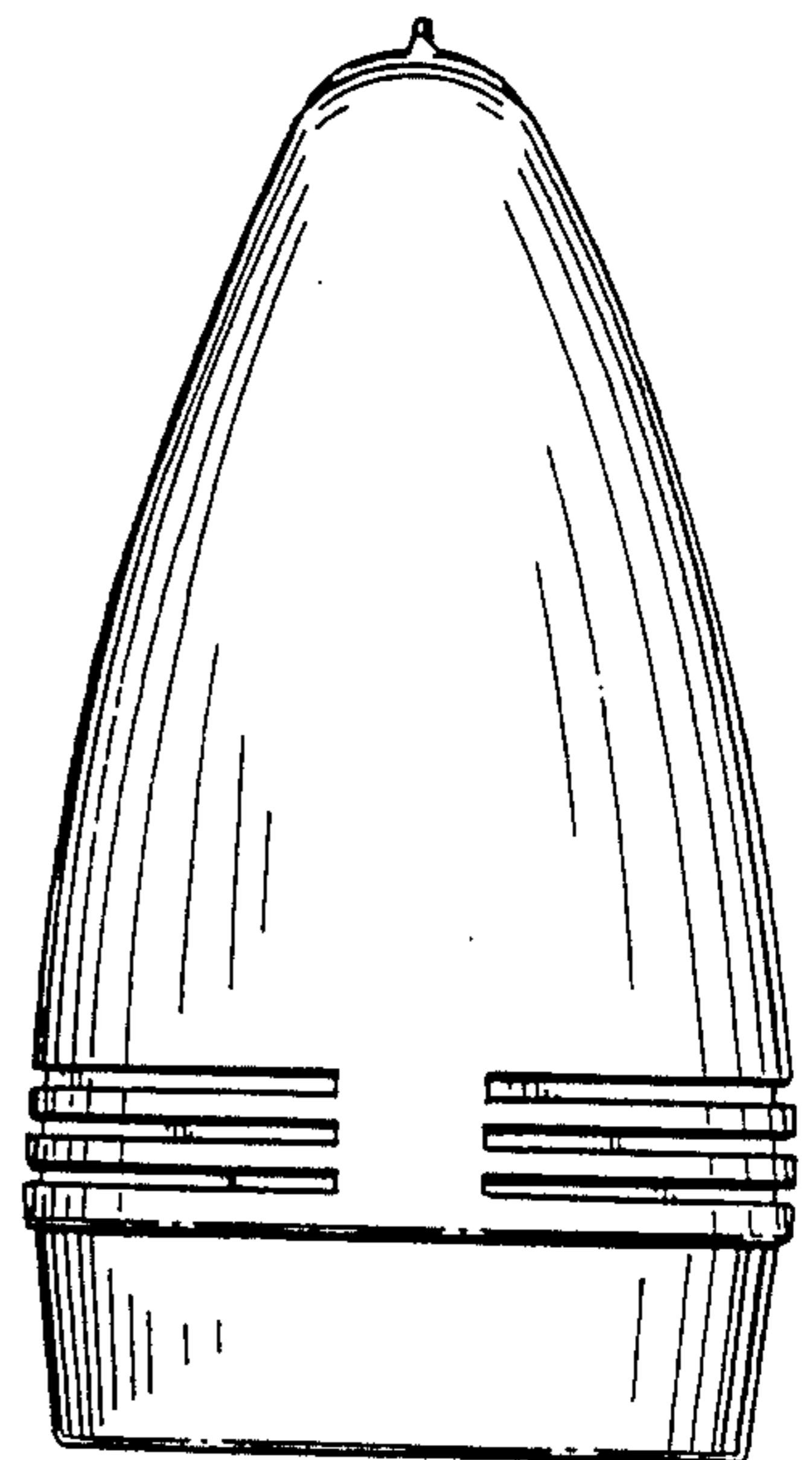
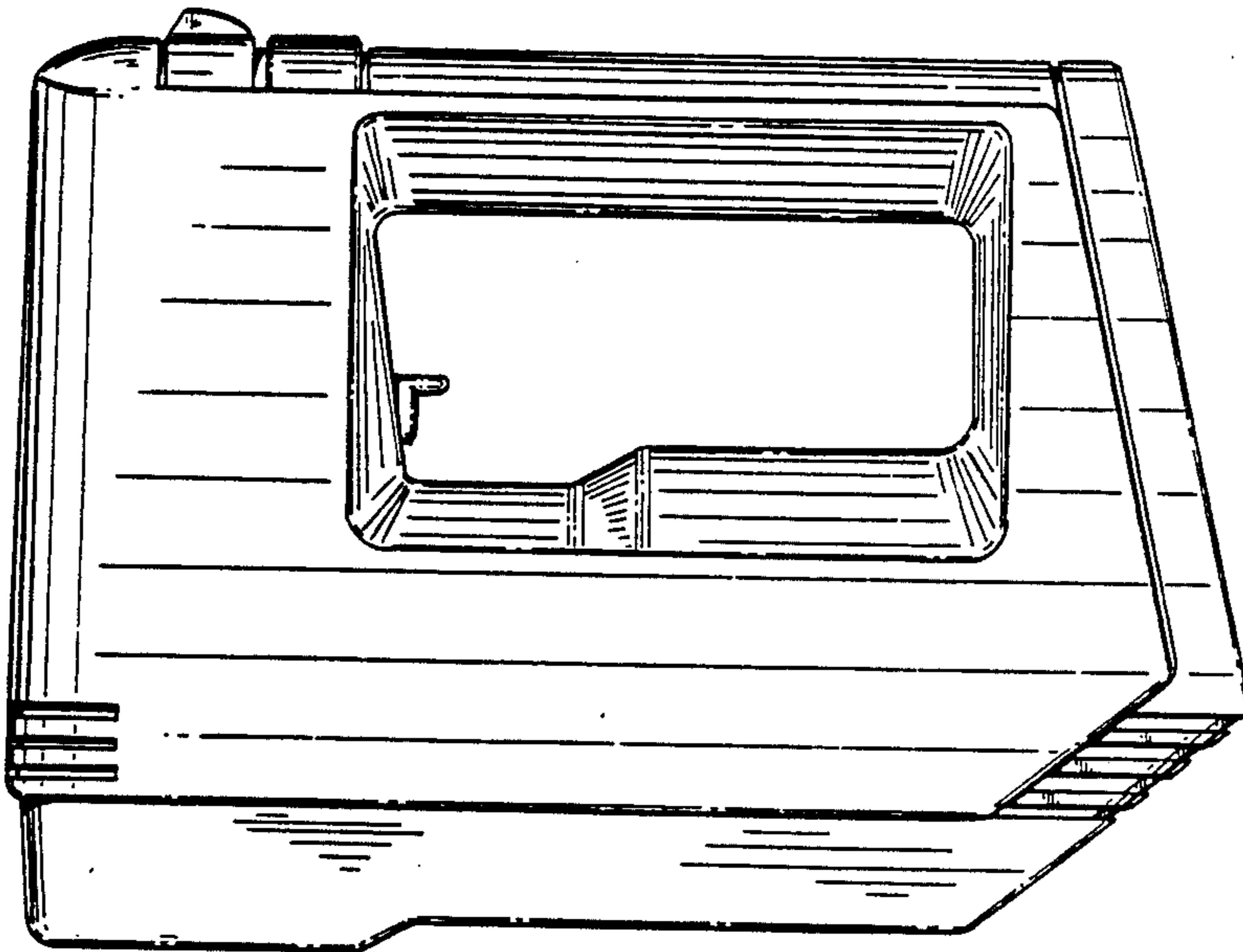

FIG. 1

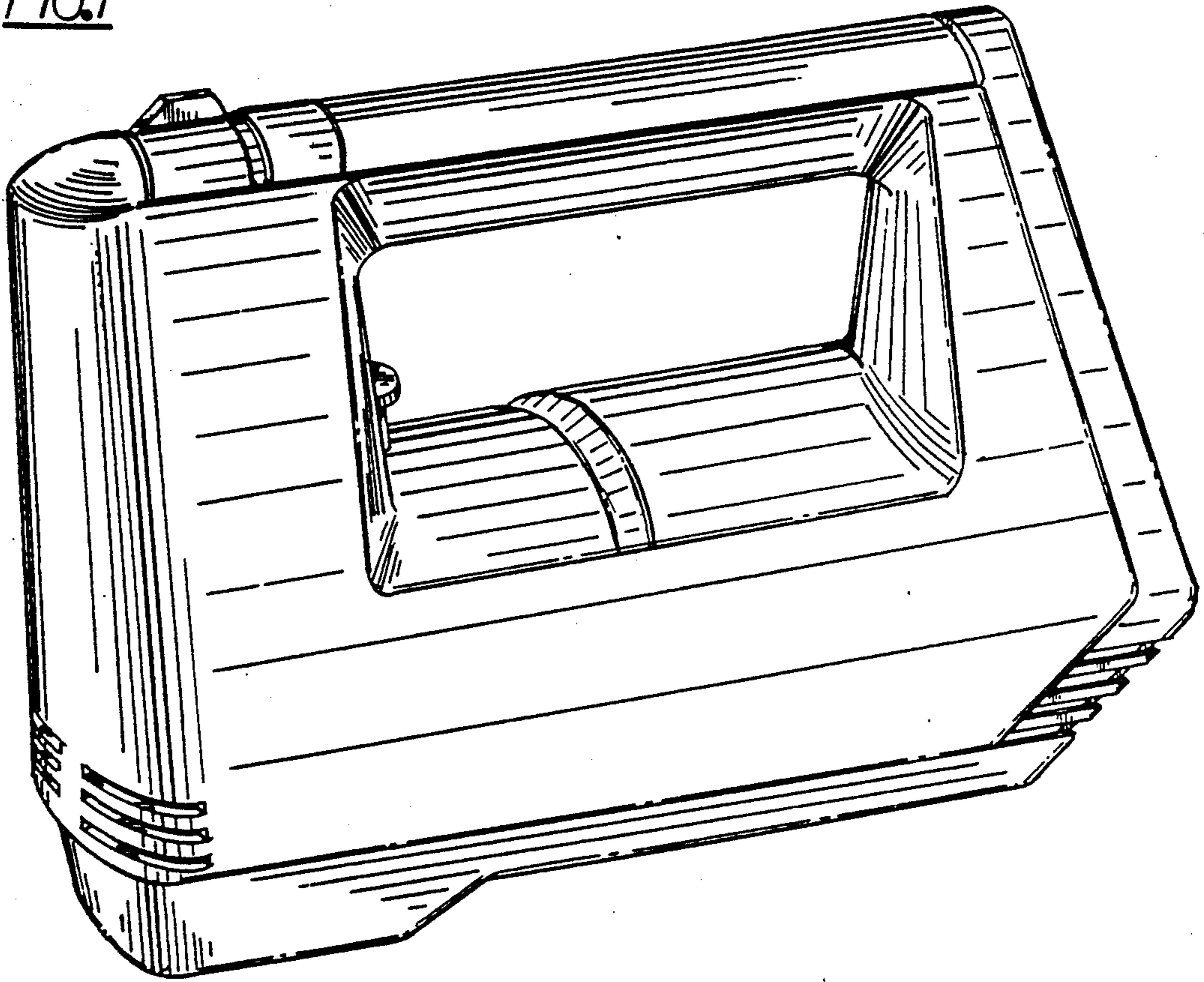

FIG. 6

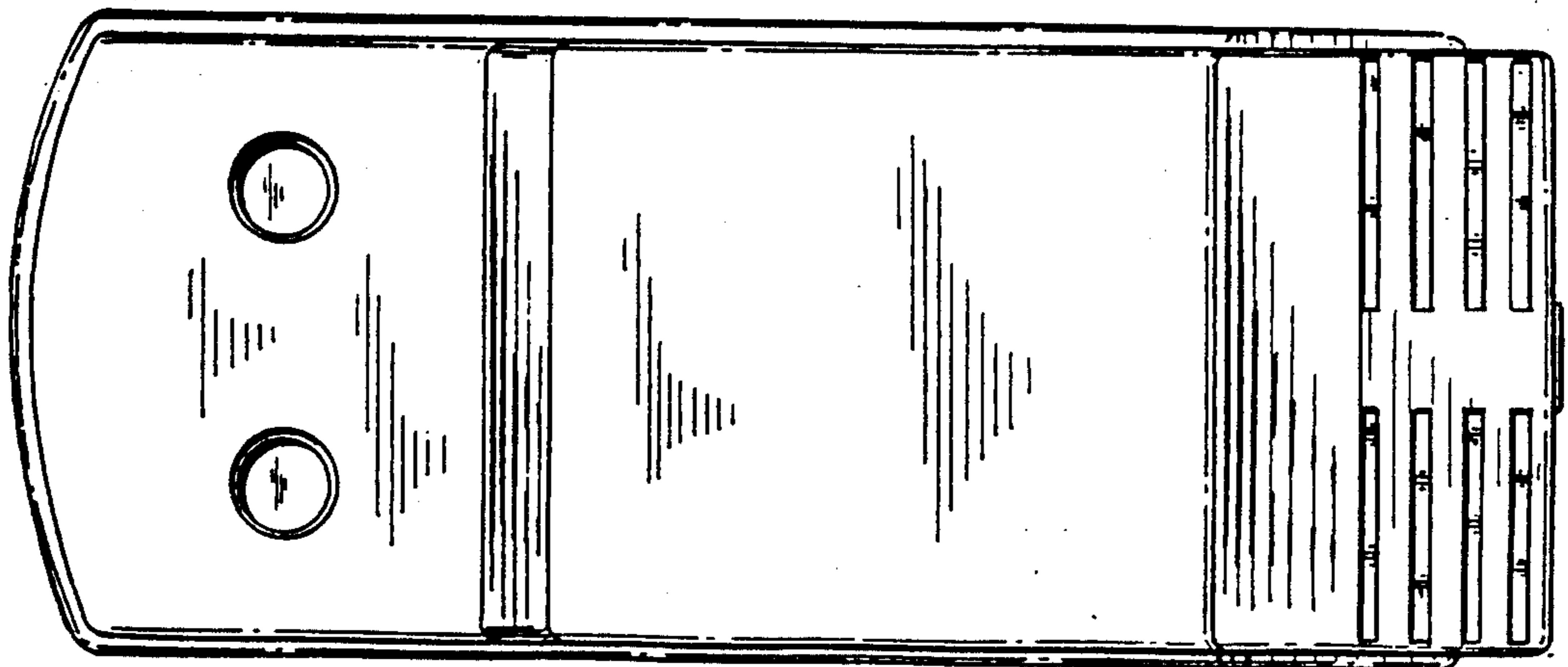

FIG.2

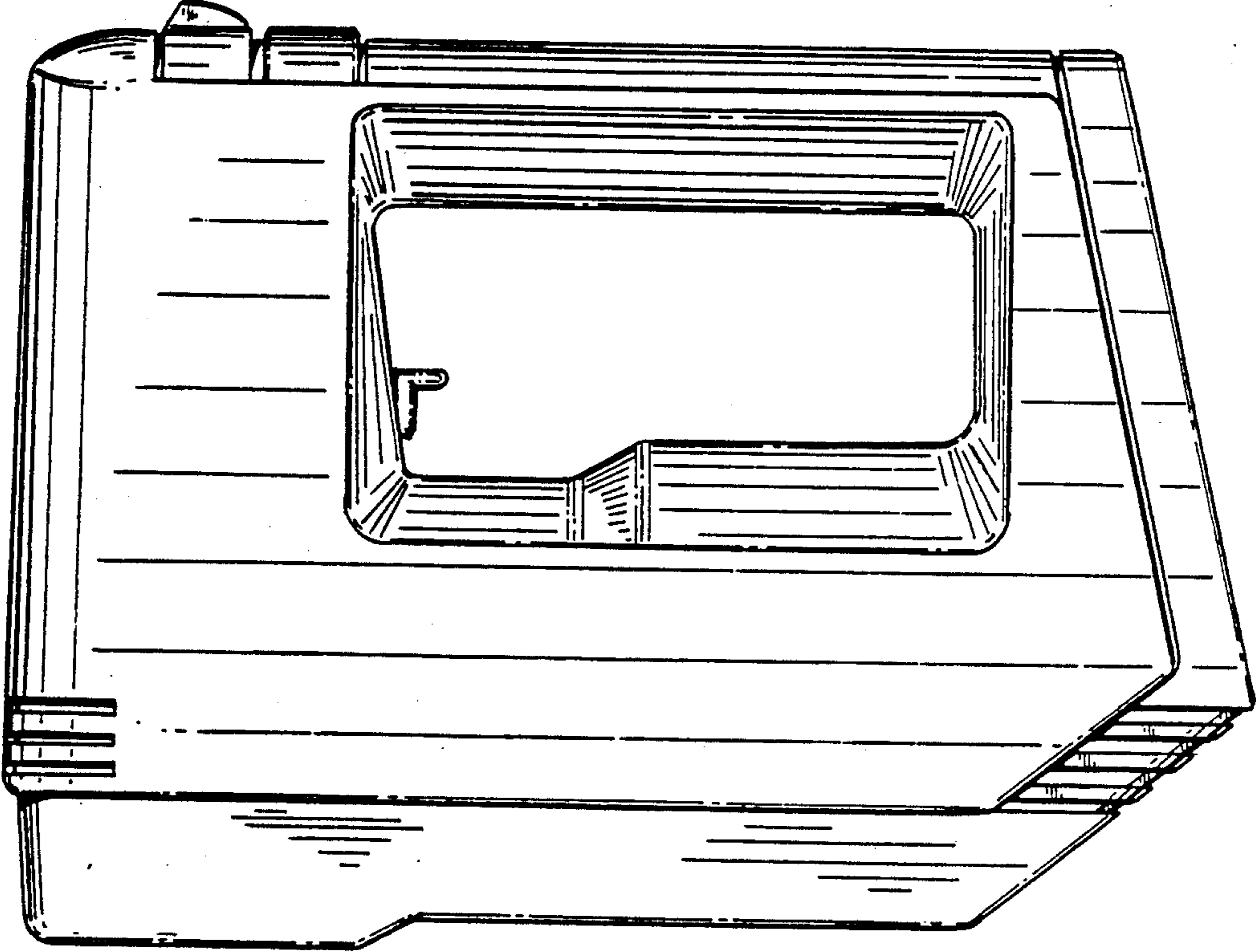

FIG.3

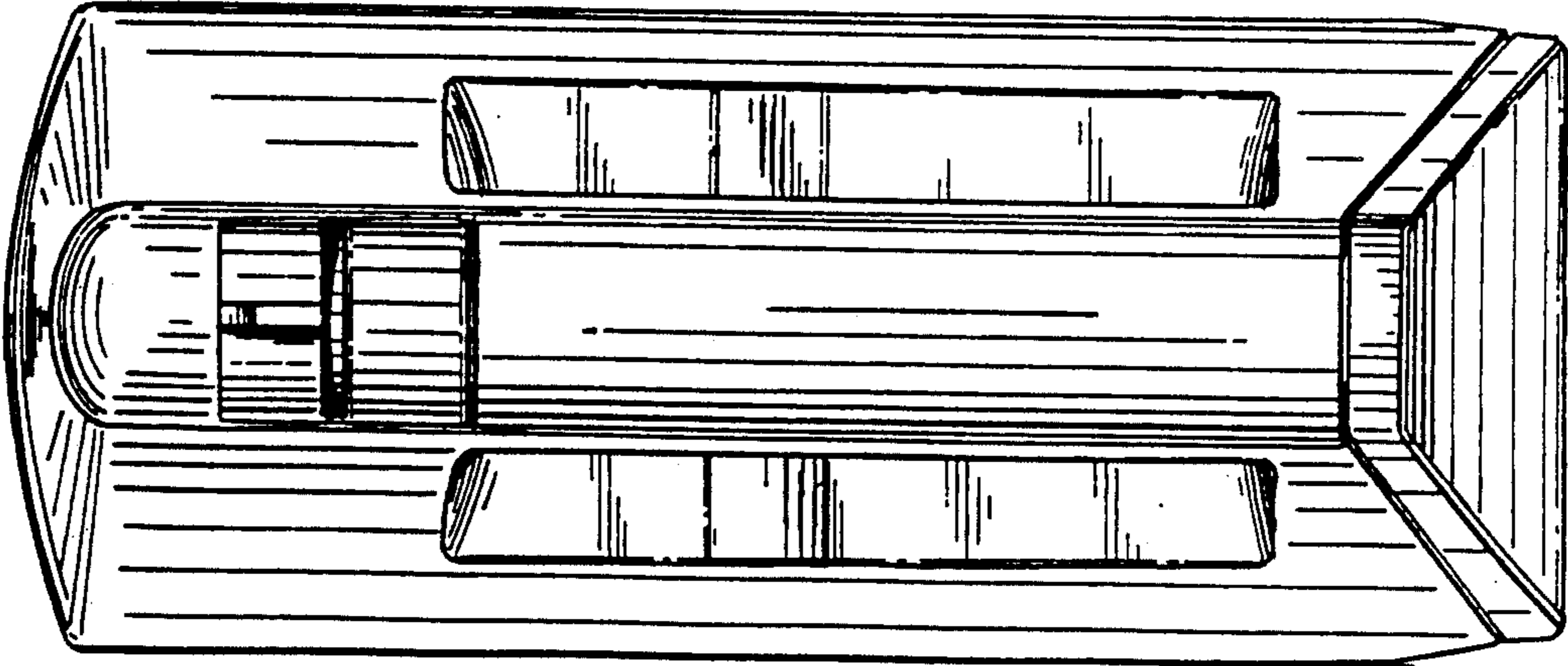

FIG.4

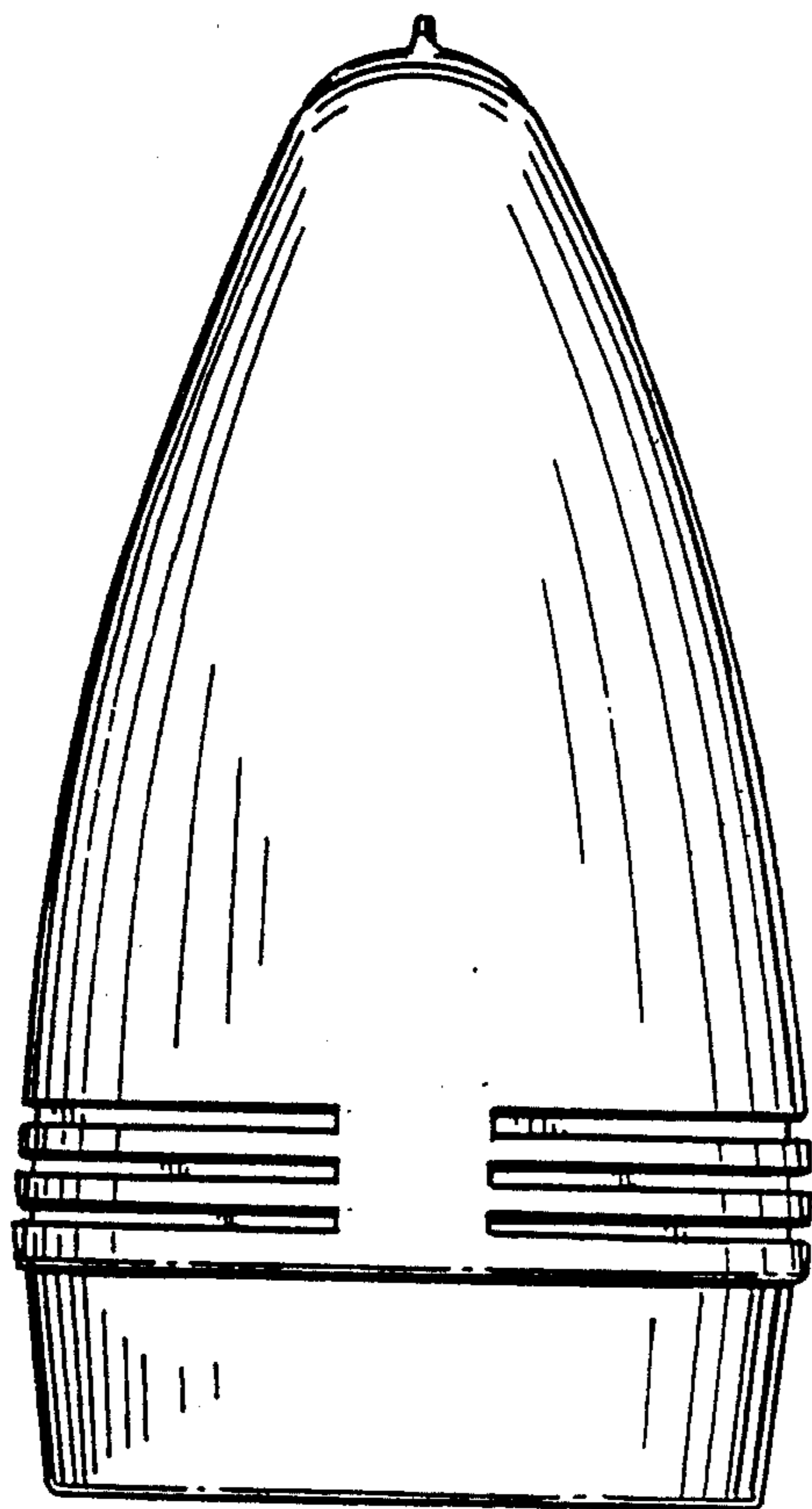

FIG.5

